

Dimplex Ultra-Slim Storage Heaters

(96513 Iss. 13)

Models XL12N, XL18N, XL24N

Twin Sensor Models XLS12N Automatic,
XLS18N Automatic, XLS24N Automatic



IMPORTANT

These instructions should be read carefully and retained for future reference. Note also the information given on the appliance.

This heater is **VERY HEAVY**. In order to maintain stability and to ensure its future safety in use, it is essential that the heater is **FIXED SOUNDLY TO A WALL** and that the feet are mounted on a **FIRM, LEVEL SURFACE**. Care should be taken to avoid irregular surfaces, such as may result from tiled surrounds partially protruding under the heater. It is important that the following instructions are strictly followed.

IT IS IMPORTANT THAT THE FIXING DEVICE CHOSEN IS APPROPRIATE TO THE WALL MATERIAL TO WHICH THE HEATER IS BEING FIXED. SOME MODERN INTERNAL BUILDING MATERIALS ARE VERY LOW DENSITY BLOCK AND REQUIRE SPECIALISED FIXING DEVICES TO PROVIDE A SAFE, SECURE INSTALLATION.

The installation of this appliance should be carried out by competent personnel and be in accordance with the current IEE wiring regulations. For the assembly of the heater tools required are a No. 2 pozidriver, an electrical screwdriver with a 4mm wide blade and a 8mm AF open ended or box spanner. A small mirror will aid insertion of the front panel retaining screws.

Only Heat Resisting Cable (min. rating T85) should be used.

DO NOT COVER OR OBSTRUCT the surfaces of the appliance.

DO NOT POSITION under windows where curtains may contact the heater. (See minimum clearances, stage 6).

DO NOT PLACE OBJECTS in contact with the heater.

If, during any reassembly of the heater, a part of the thermal insulation shows damage or deterioration which may impair safety, it should be replaced with an identical part.

Connection to a 30 amp Ring Circuit

XLN/XLSN STORAGE HEATERS SHOULD NOT BE CONNECTED TO A 30 AMP RING CIRCUIT. XL/XLS24N STORAGE HEATERS SHOULD NOT BE CONNECTED TO A FUSED SPUR.

Bricks are in packs of two.
The pack catalogue number is XT 8300

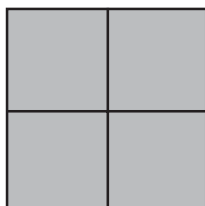

XL12/XLS12N - 12kWh
8 Bricks (4 Packs)

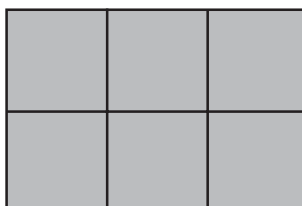

XL18/XLS18N - 18kWh
12 Bricks (6 Packs)



XL24/XLS24N - 24kWh
16 Bricks (8 Packs)

Circuit Diagram

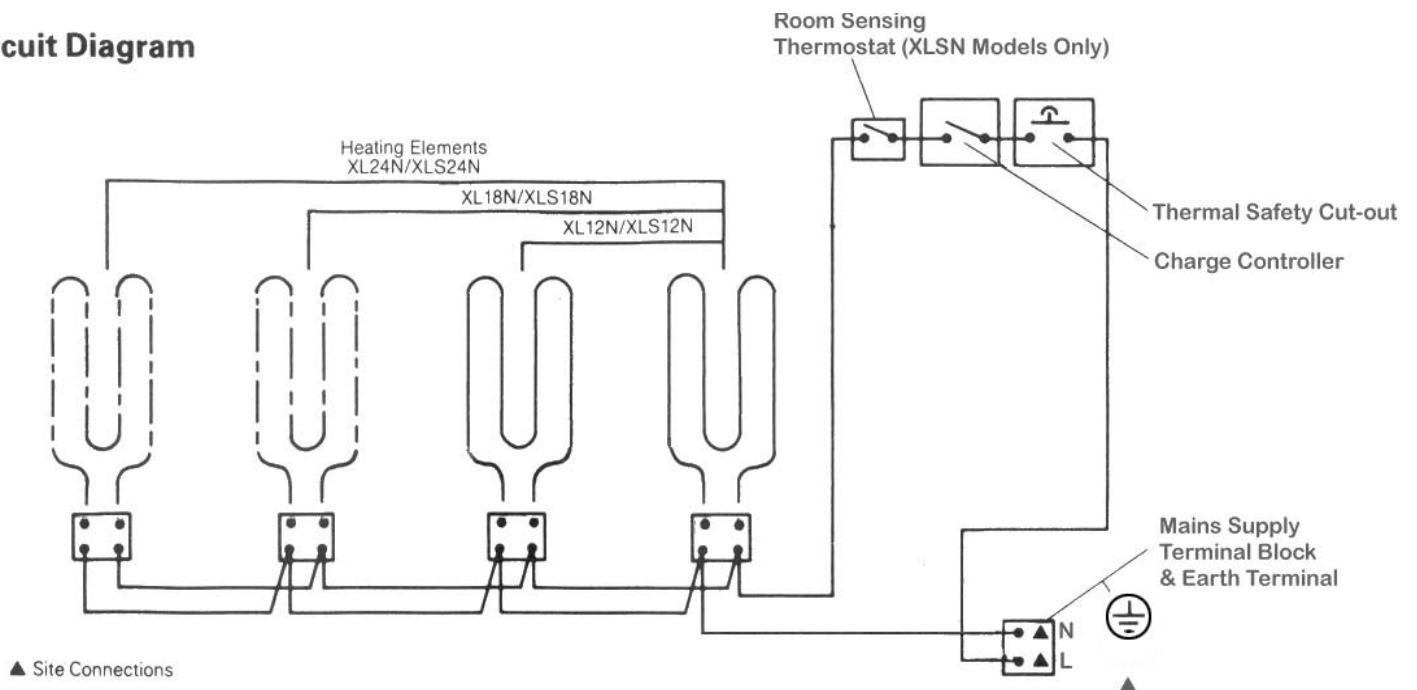

Assembly of heater

1. Invert the carton and carefully lift carton off heater. Do not remove internal packaging pieces at this stage!

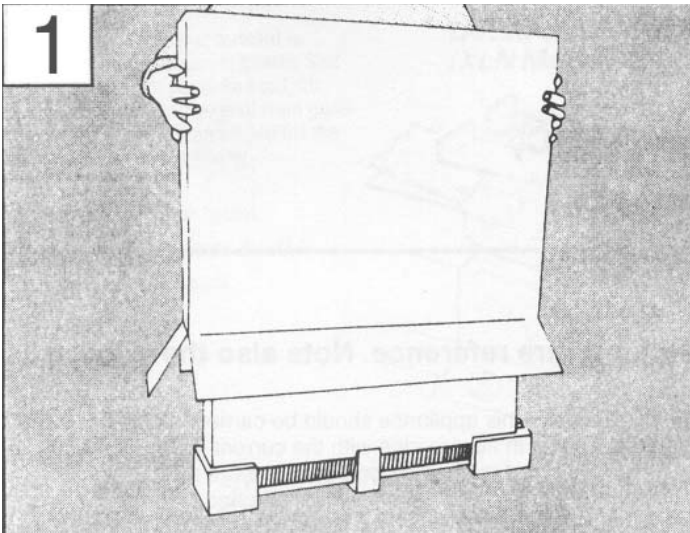

2. Remove the feet and accessories bag from corner fittings (accessories bag is located within one of the feet).

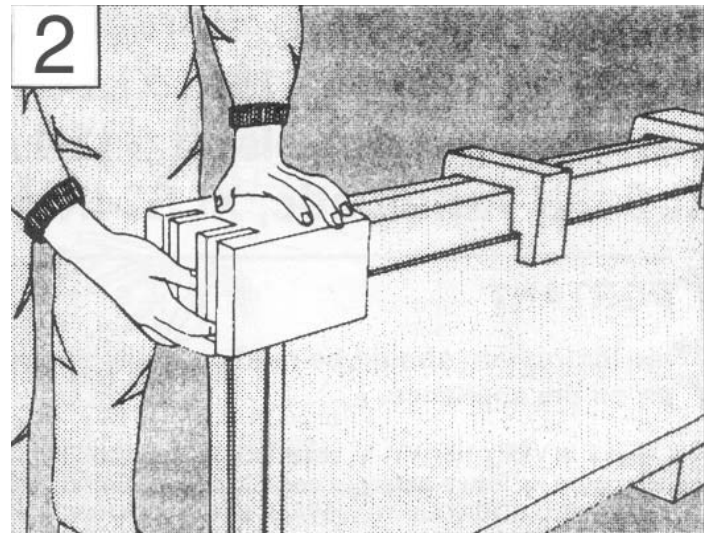

3. Secure the feet to base of heater using the Taptite screws provided (two for each foot). It is necessary on XL12N/XLS12N models, to remove base corner packaging pieces to locate feet in position.

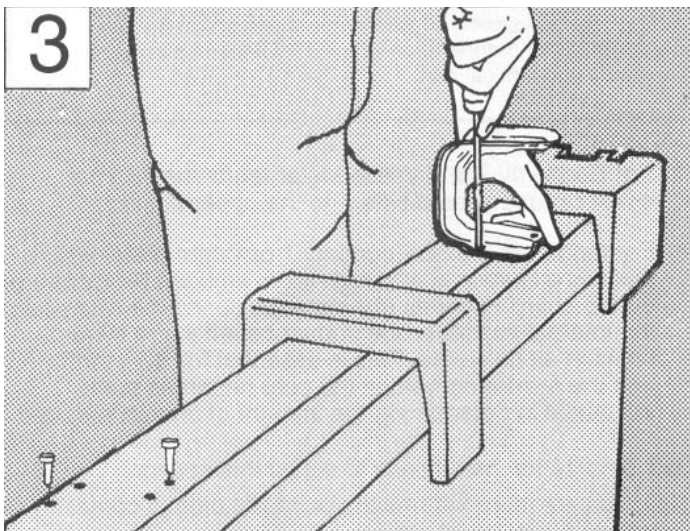

4. Loosen hexagon head front panel securing screws, by 1 - 2 turns using screwdriver through aperture in each end packing piece.

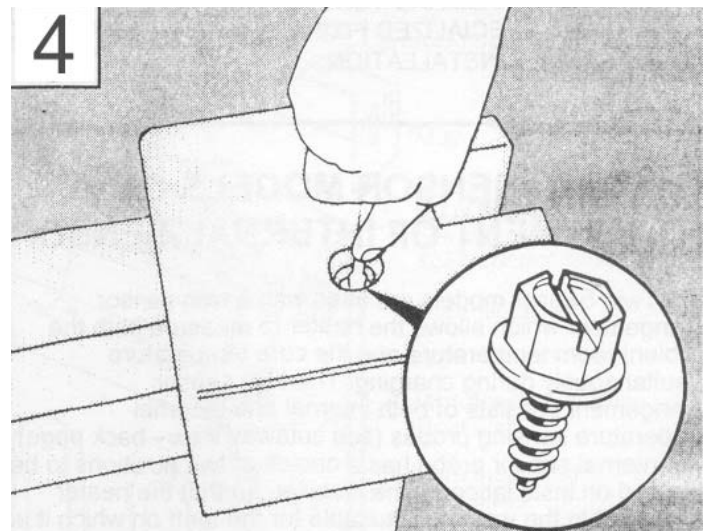

5. Stand heater on its feet and remove all packaging pieces.

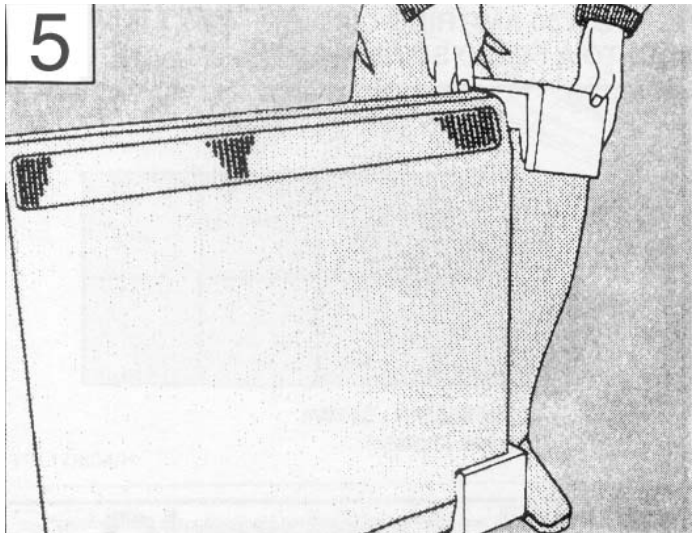

6. IMPORTANT XLS Models Only - Locating the external sensor

The sensor is situated at the rear of the lower right corner of the heater.

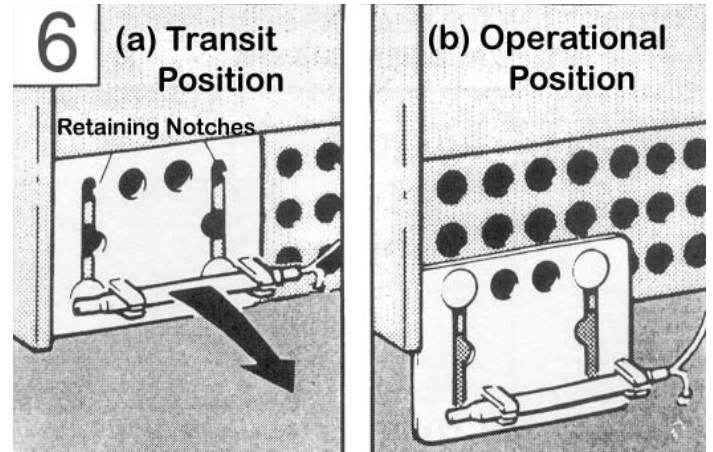

- a) Remove sensor carefully from its retaining clips and move to one side.
- b) Slide down plastic sensor carrier as far as it will go so that the two plastic fixings are above the retaining notches. Replace sensor carefully in its retaining clips.

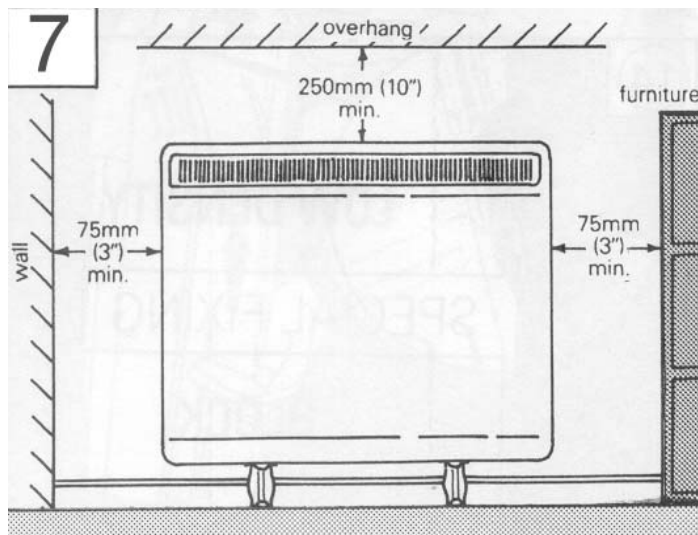

7. Position heater against wall in intended final position, taking note of the minimum fixing dimensions. If fitted, the Dimplex storage heater shelf should be fixed in accordance with the instructions enclosed with the shelf.

8. If the floor is carpeted then the carpet should be slit and underlay cut away to allow the feet to rest firmly on the floor. Carpet gripper must be locally removed so that the feet may rest in a level position.

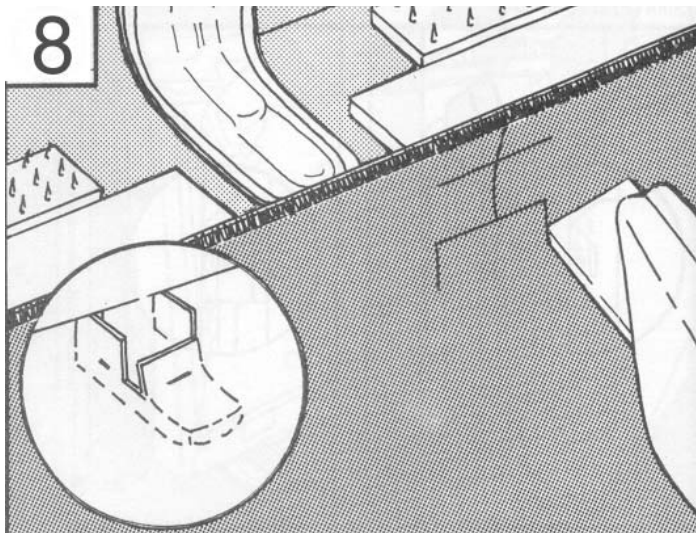

9. Having prepared, where necessary, the floor, the position of the wall bracket should be marked on the wall.

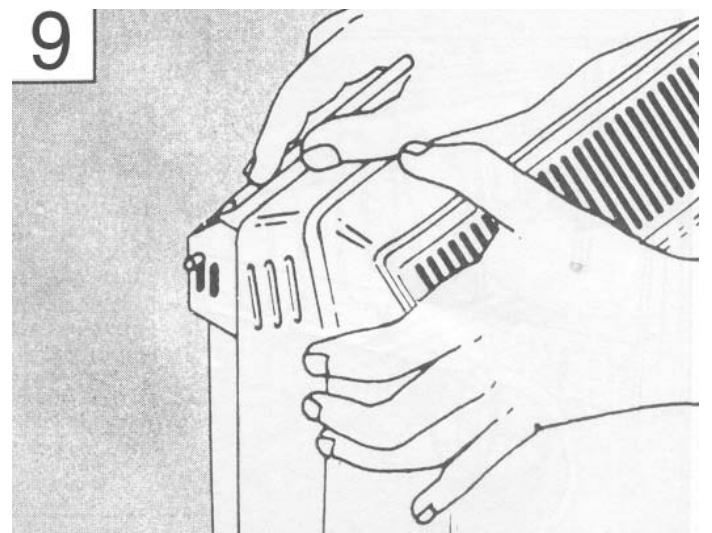

10. Remove wall fixing bracket from heater by removing the screws at each end.

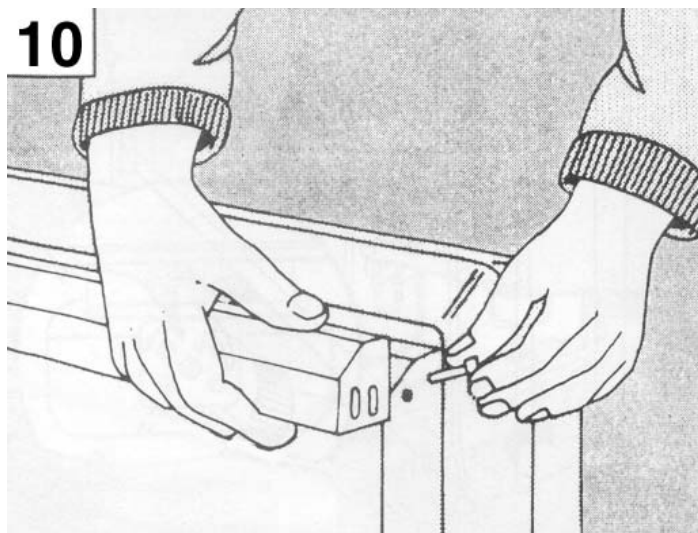

11. Mark wall bracket fixing positions and screw wall bracket to wall following closely the guidelines in steps 12 and 13. NOTE: It is essential that two of the fixing points are the lower short fixing slots at each end of the wall bracket.

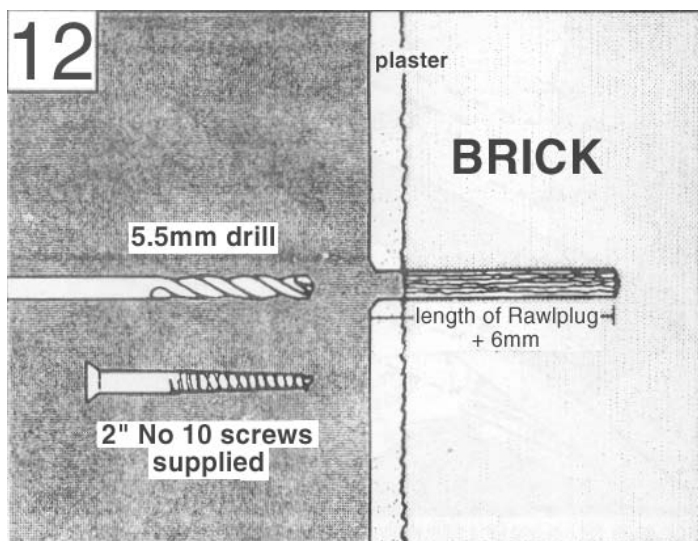
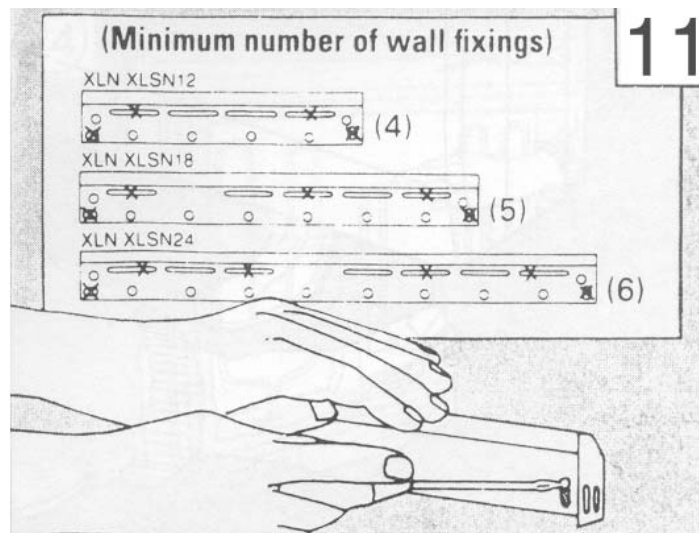

12. **Solid Brick/High Density Block Walls.** (See step 13 if walls are low density block.) These must be drilled and plugged with the Rawlplug No. 10 size fibre inserts provided. The correct size of drill (5.5mm) should be used and the hole should be drilled to a depth of 6mm greater than the length of the Rawlplug so that the fixing is made below the plaster layer.

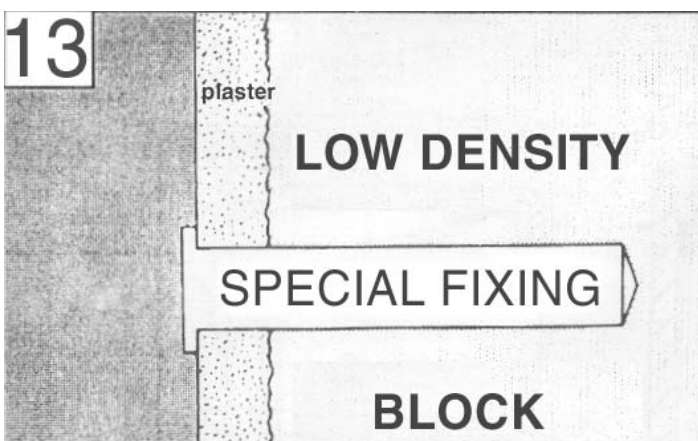

13. **Low Density Block Walls.** A specialised fixing, such as the Unifix LB70, should be employed following closely the manufacturer's instructions.
Panelled Internal Walls. Here it is best to locate the studding and use No. 10 size woodscrews. Where it is not possible to locate the studding use type M5 Rawlplug INTERSETS on securely fastened plasterboard panelling. For other wall panel materials the wall panel manufacturer should be consulted for details of suitable wall fixing devices.

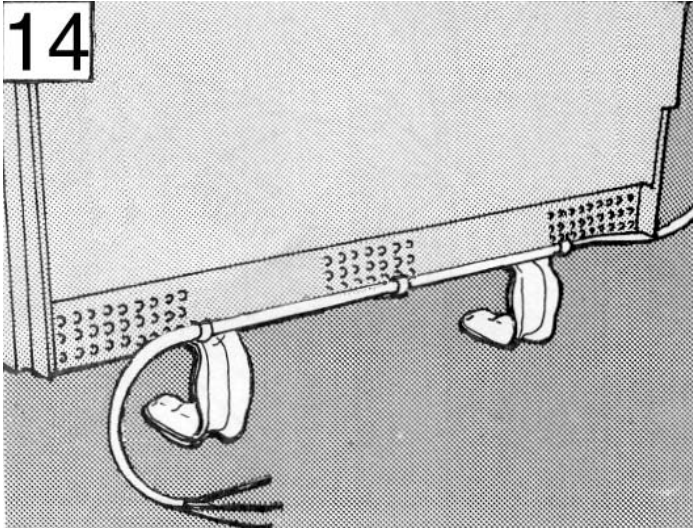

14. If left hand cable connection is required, the cable support straps supplied in the fixing kit should be fitted to the base of the rear of the heater, and the supply cable fed through them. Ensure sufficient spare cable is fed through the straps to make the mains connection.

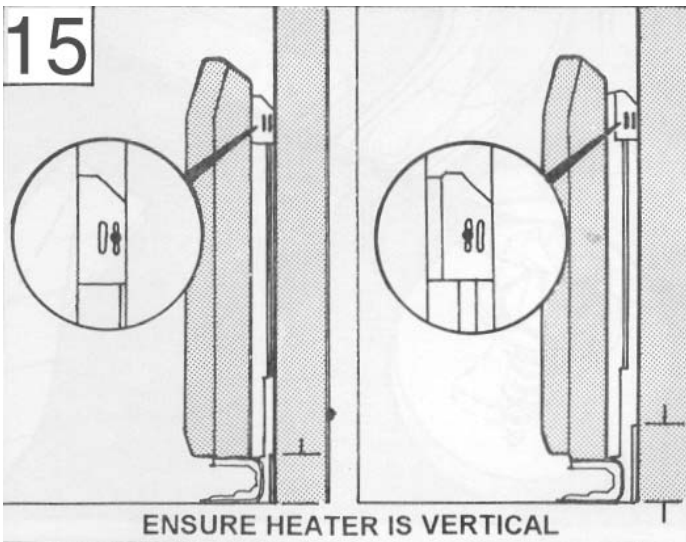

15. Secure heater to wall fixing bracket by replacing the two screws removed in step 10 (do not fully tighten these screws until the bricks are loaded into the heater as some settling of the heater may occur). The feet and wall mounting arrangement are designed to accommodate skirting board sizes up to 25mm (1") thick. **To avoid obstructing the airflow to the rear of the heater the following must be strictly adhered to:**

- (a) For skirtings higher than 100mm (4") it will be necessary to position the heater with the screws attached through the alternative fixing slots to the front.
- (b) For skirtings having a height in excess of 150mm (6") it will be necessary to reduce the height of the skirting to 150mm (6") over the entire length of the heater plus 25mm (1") at either end.

16. Remove bottom front panel securing screws. These were loosened in step 4 and should be easily unscrewed by hand.

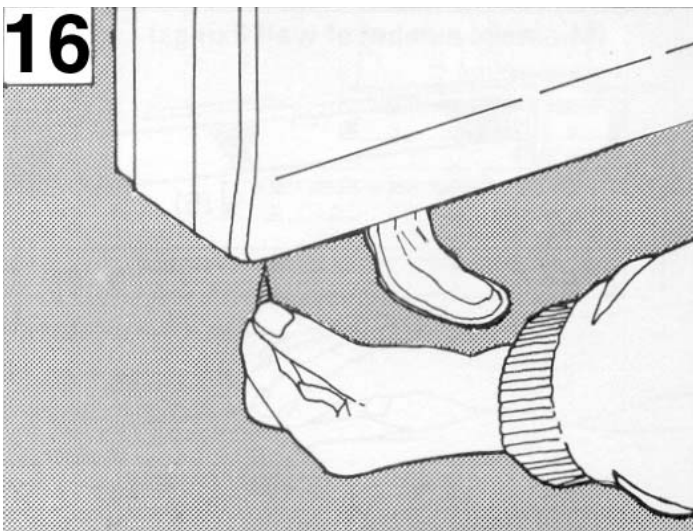

17. Pull bottom of front panel forward to disengage it from bottom of heater.

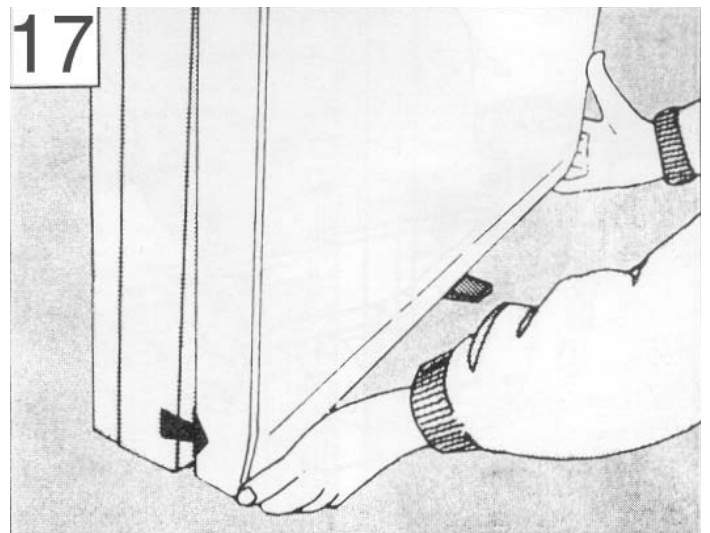

18. Still holding the bottom of front panel forward, lift upwards to disengage top edge of front panel from groove on heater top panel ①, and remove front panel from heater ②.

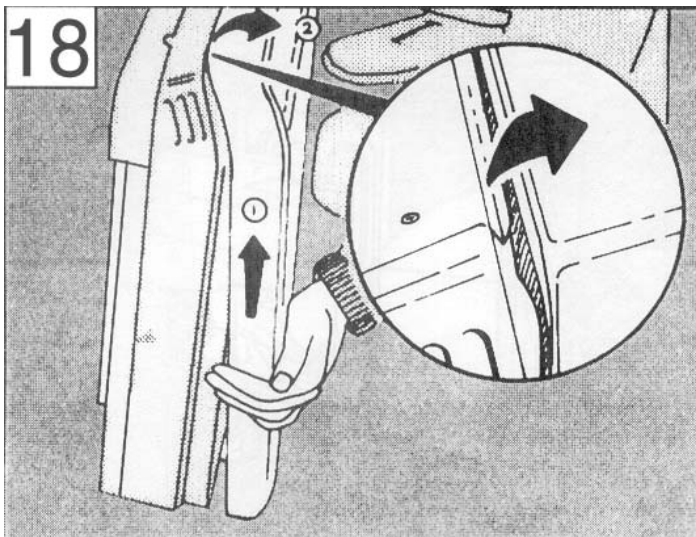

19. Remove the protective polystyrene packing from the front inner skin panel and discard. Remove screws retaining front inner skin.

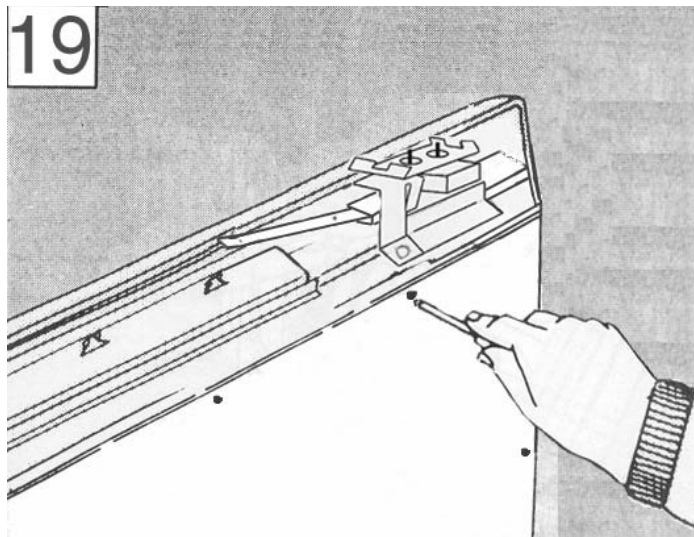

20. Carefully lift the bottom of the front inner skin panel out of the retaining flange at the base of the heater, taking care not to damage the insulation attached to this panel.

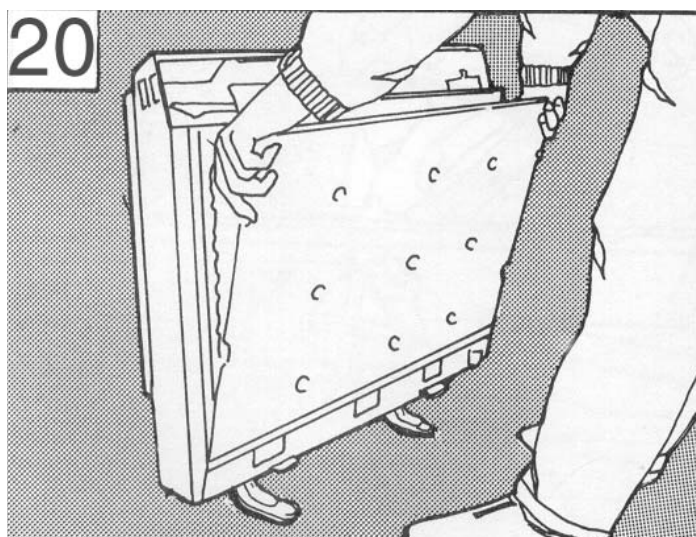

21. Remove the internal packing by sliding it up and off the elements, taking care not to damage the insulation.

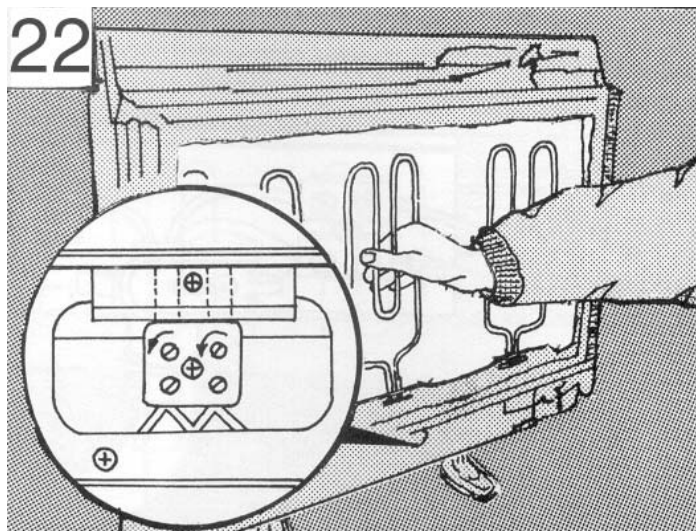
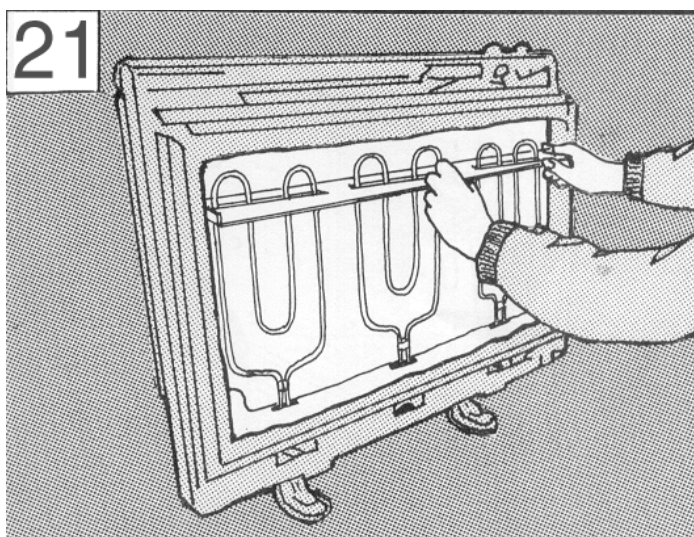

22. Remove one element to allow access for the back row of bricks. On the XL/XLS24N remove the element to the right of centre, on the XL/XLS18N remove the central element and on the XL/XLS12N remove the left hand element. Loosen the two screws securing the element tails in the ceramic block, and lift the element up and out of the heater.

23. Position the bottom rear layer of bricks with the recess over the slots in the base insulation slab. Push the bricks firmly to the back of the heater, then fit the top row of bricks.

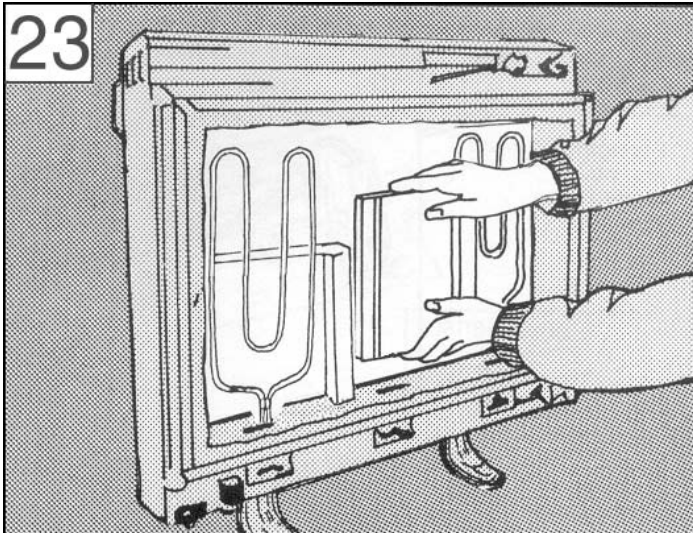

24. Replace the element which had been removed by carefully passing the ends through the base insulation slots into the terminal blocks below. Position the insulator on the element end in contact with the terminal block ceramic as shown, and tighten the connection screws. At this point check that all element connections are tight.

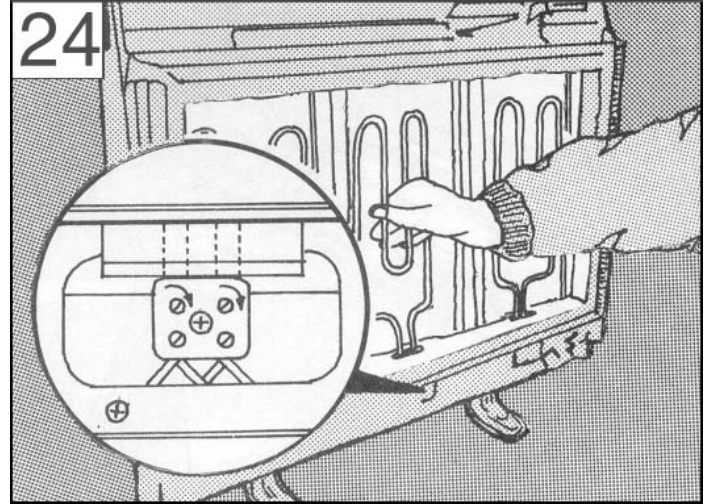

25. Fit the front bricks with the airways facing inwards.

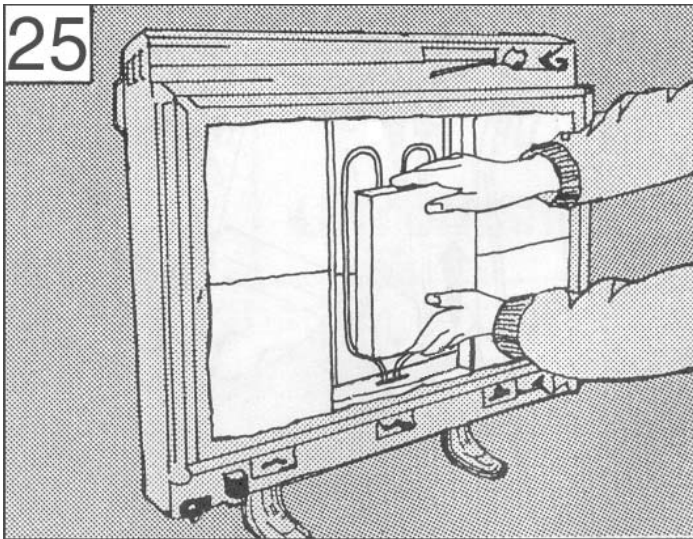

26. Re-fit the inner front panel/insulation assembly, ensuring the bottom edge of the panel is located behind the base flange. Make sure all screws removed in Operation 19 are replaced securely.

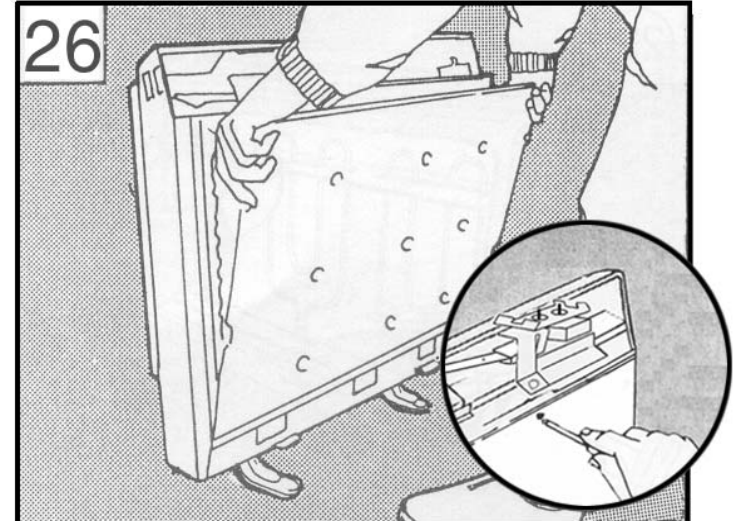

27. Check that the damper mechanism within the heater functions freely, by rotating the left hand control knob. Check also that the right hand (input) knob rotates freely.

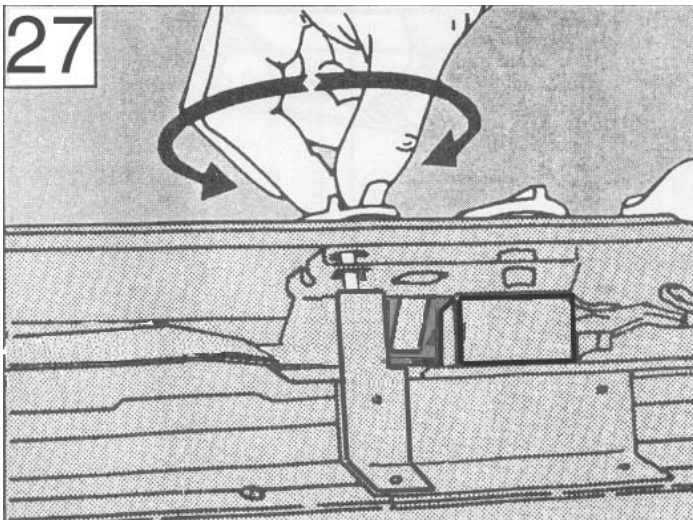

28. Introduce mains supply cable through the cable clamp into the terminal area, and connect in accordance with the terminal markings. **HEAT RESISTING CABLE MUST BE USED (min. T85). Ensure that the cable is clamped so that there is no excess cable in the terminal area. ON NO ACCOUNT SHOULD ANY SURPLUS CABLE BE PUSHED INSIDE OR BEHIND THE HEATER. CHECK ALL ELECTRICAL CONNECTIONS FOR TIGHTNESS.**

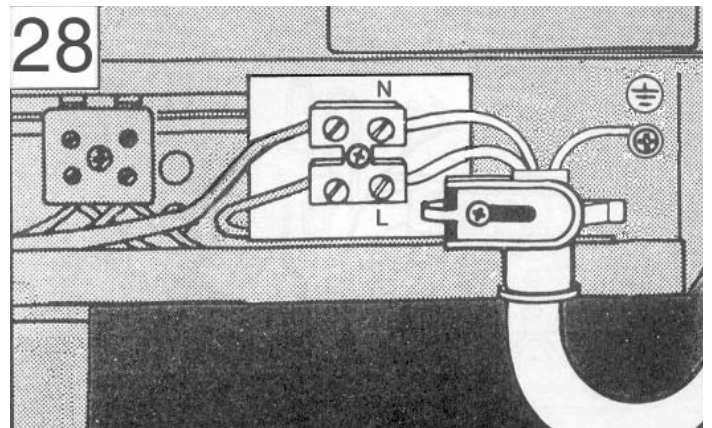

29. Holding the bottom edge of the front panel towards you, locate the top edge of the front panel in the groove at the top of the heater.

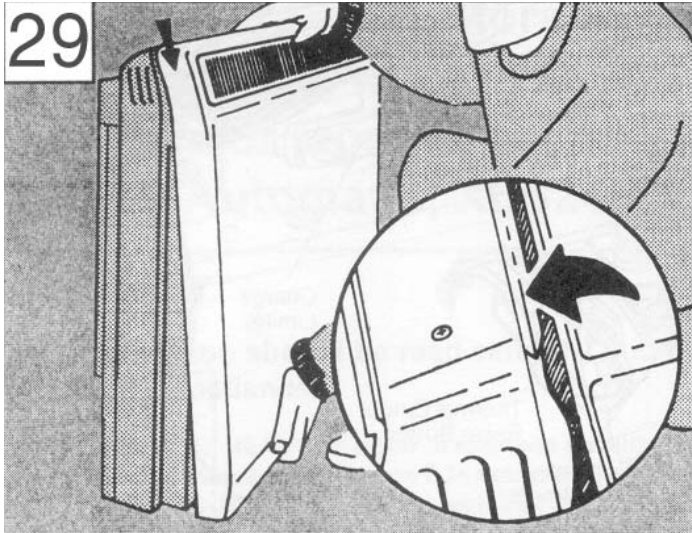

30. Push the bottom of the front panel towards the heater, so that the bottom flange locates under the base.

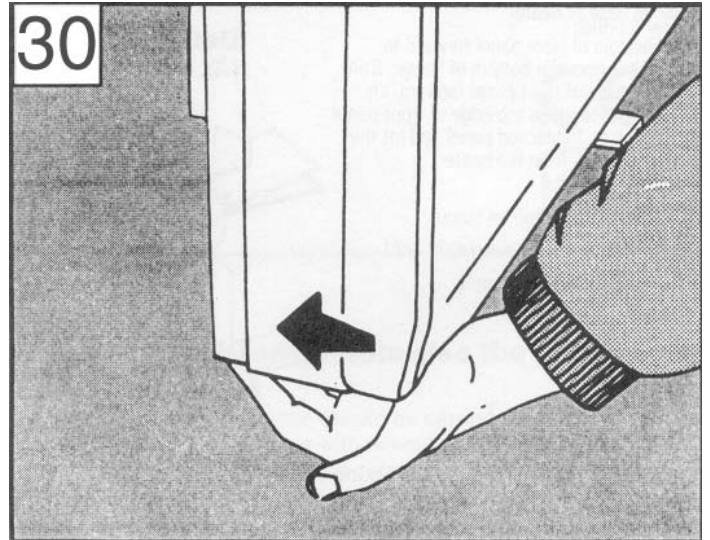

31. Replace the two front panel securing screws removed in operation 16. A small mirror on the floor under the heater will help location of the threaded holes in the base. These should be tightened using an 8mm AF socket or open ended spanner.

Ensure all screws have been fully tightened.

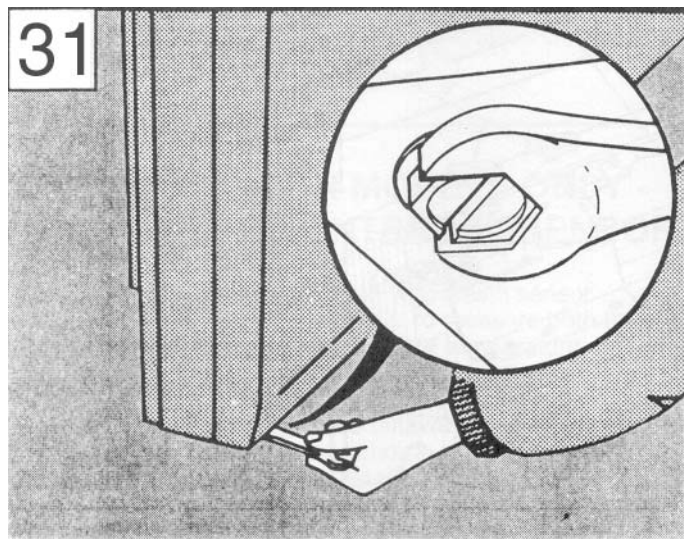

32. **Ensuring the electricity supply is disconnected, connect the free end of the mains cable to a suitable double-pole switch adjacent to the appliance - reinstate the electricity supply.**

NOTE: The double pole switch must have a contact separation of at least 3mm in all poles.

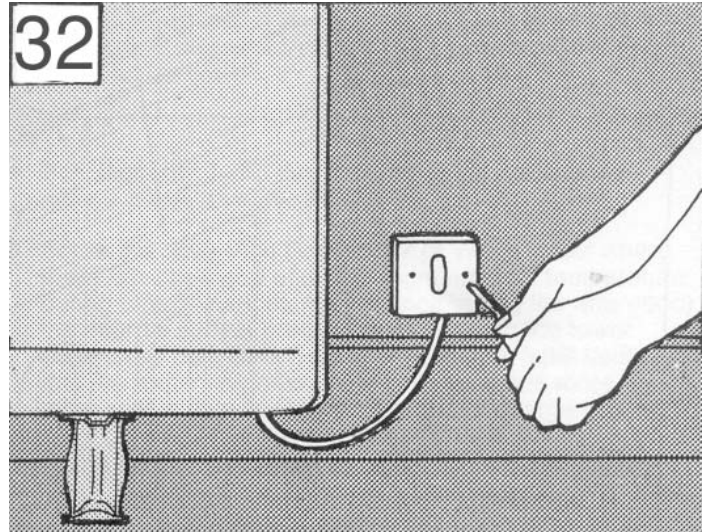

DC Dimplex

Glen Dimplex UK Limited
Millbrook House,
Grange Drive, Hedge End,
Southampton SO30 2DF



Customer Help Line
Product Sales
Head Office
e-mail customer.services@glendimplex.com

0870 7270 101
0870 7270 103
0870 0777 117

[C] Glen Dimplex UK Limited

All rights reserved. Material contained in this publication may not be reproduced in whole or part, without prior permission in writing from Glen Dimplex UK Limited.