

THE TOOL COMPANY

SUBMERSIBLE WATER PUMPS

■ STOCK Nos. 54657 - 230V
35463 - 230V
35464 - 230V
52064 - 110V
35465 - 230V
35467 - 230V
52066 - 110V
35466 - 230V
64275 - 230V
64274 - 230V
69690 - 230V

■ PART Nos. SWP110ADW
SWP120
SWP120A
SWP120A
SWP144A
SWP235ADW
SWP235ADW
SWP250A
SWP120ASS
SWP235ADWSS
SWP320ADW

• INSTRUCTIONS •

IMPORTANT: PLEASE READ THESE INSTRUCTIONS CAREFULLY TO ENSURE THE SAFE AND EFFECTIVE USE OF THIS TOOL.



GENERAL INFORMATION

This manual has been compiled by Draper Tools and is an integrated part of the product with which it is enclosed and should be kept with it for future references.

This manual describes the purpose for which the product has been designed and contains all the necessary information to ensure its correct and safe use. We recommend that this manual is read before any operation or, before performing any kind of adjustment to the product and prior to any maintenance tasks. By following all the general safety instructions contained in this manual, it will ensure both product and operator safety, together with longer life of the tool itself.

All photographs and drawings in this manual are supplied by Draper Tools to help illustrate the operation of the product.

Whilst every effort has been made to ensure accuracy of information contained in this manual, the Draper Tools policy of continuous improvement determines the right to make modifications without prior warning.

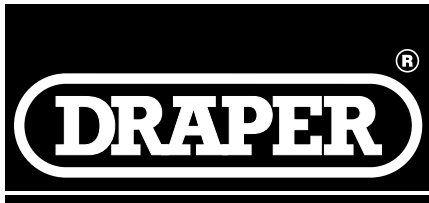

THE TOOL COMPANY

SUBMERSIBLE WATER PUMPS

■ STOCK Nos. 54657 - 230V
 35463 - 230V
 35464 - 230V
 52064 - 110V
 35465 - 230V
 35467 - 230V
 52066 - 110V
 35466 - 230V
 64275 - 230V
 64274 - 230V
 69690 - 230V

■ PART Nos. SWP110ADW
 SWP120
 SWP120A
 SWP120A
 SWP144A
 SWP235ADW
 SWP235ADW
 SWP250A
 SWP120ASS
 SWP235ADWSS
 SWP320ADW

CONTENTS:

Contents/Declaration 1
 Specification/Guarantee 2
 Power Supply 3
 General Safety Instructions 4
 Additional Safety Rules for Submersible Water Pump 5
 Getting to Know Your Submersible Water Pump 6
 Operation and Use 7-9
 Maintenance 9
 Optional Accessories 10
 Trouble Shooting 11

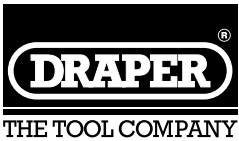

DECLARATION OF CONFORMITY

We
 Draper Tools Ltd. Hursley Road, Chandler's Ford, Eastleigh, Hampshire.
 SO53 1YF. England.

Declare under our sole responsibility that the product:

Stock Nos:- 54657, 35463, 35464, 35465, 35466, 35467, 52064, 52066, 64274, 64275 & 69690.

Part Nos:- SWP110ADW, SWP120, SWP120A, SWP144A, SWP250A, SWP235ADW, SWP120A/110, SWP235ADW/110, SWP235ADWSS, SWP120ASS & SWP320ADW.

Description:- Submersible Waterpumps.

To which this declaration relates is in conformity with the following directive(s) 98/37/EC, 73/23/EEC & 89/336 EEC

With reference to: EN60335-1, EN60335-2-41, EN292-1, EN292-2, EN50081-1, EN55014-1, EN61000-3-2 & EN61000-3-3

JOHN DRAPER
Managing Director

13/01/2003

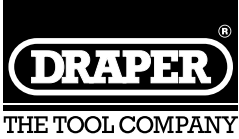

SPECIFICATION

The Draper Tools policy of continuous improvement determines the right to change specification without notice.

Stock No.	54657	35463	35464/52064	64275	35465	35467/52066	64274	35466	69690
Part No.	SWP110ADW	SWP120	SWP120A	SWP120ASS	SWP144A	SWP235ADW	SWP235ADWSS	SWP250A	SWP320ADW
Max. Head Height	6M	6M	6M	6M	7M	8.5M	8.5M	9.5M	11M
Min. Water Level	35mm	10mm	10mm	10mm	10mm	35mm	30mm	10mm	35mm
Output Diameter	1¼"	1"	1"	1"	1"	1¼"	1¼"	1¼"	1½"
Max. Particle Size Ø	30mm	4mm	4mm	4mm	4mm	30mm	30mm	4mm	38mm
Max. Output	110L/Min	120L/Min	120L/Min	120L/Min	144L/Min	235L/Min	235L/Min	250L/Min	320L/Min
Motor (Watts)	280	200	200	200	350	700	700	700	230
Voltage	230V	230V	230V/110V	230V	230V	230V/110V	230V	230V	230V
Thermal overload Protection	Yes	Yes	Yes	Yes	Yes	Yes	Yes	Yes	Yes
Rotor Shaft Ceramic Coated	Yes	Yes	Yes	Yes	Yes	Yes	Yes	Yes	Yes

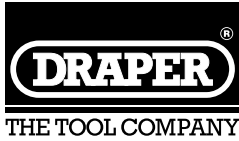

GUARANTEE

Draper Tools have been carefully tested and inspected before shipment and are guaranteed to be free from defective materials and workmanship for a period of 12 months from the date of purchase except where tools are hired out when the guarantee period is ninety days from the date of purchase.

Should the machine develop any fault, please return the complete tool to your nearest authorized warranty repair agent or contact Draper Tools Limited, Chandler's Ford, Eastleigh, Hampshire, SO53 1YF. England. Telephone: (023) 8026 6355.

If upon inspection it is found that the fault occurring is due to defective materials or workmanship, repairs will be carried out free of charge. This guarantee does not apply to normal wear and tear, nor does it cover any damage caused by misuse, careless or unsafe handling, alterations, accident, or repairs attempted or made by any personnel other than the authorised Draper warranty repair agent.

This guarantee applies in lieu of any other guarantee expressed or implied and variations of its terms are not authorised.

Your Draper guarantee is not effective unless you can produce upon request a dated receipt or invoice to verify your proof of purchase within the 12 month period.





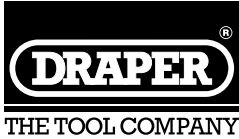

Please note that this guarantee is an additional benefit and does not affect your statutory rights.

Draper Tools Limited.



POWER SUPPLY

CONNECTING YOUR MACHINE TO THE POWER SUPPLY: (230V ONLY)

To eliminate the possibility of an electric shock your machine has been fitted with a BS approved, non rewirable moulded plug and cable which incorporates a fuse, the value of which is indicated on the pin face of the plug. If the plug is marked with the  symbol and the fuse needs replacing, an  approved BS1362 fuse must be used of the same amp rating. If the plug is not  marked, a fuse with the  symbol,  BS Kitemark, or both  and  BS Kitemark, of the same amp rating should be used.

The fuse cover is detachable, never use the plug with the cover omitted. If a replacement fuse cover is required, ensure it is the same colour as that visible on the pin face of the plug (i.e. red). Fuse covers are available from your Draper Tools stockist.

If the fitted plug is not suitable, it should be cut off and destroyed. *The end of the cable should now be suitably prepared and the correct type of plug fitted. See below.

***WARNING:**

A plug with bare flexible wires exposed is hazardous if engaged in a live power socket outlet.

WARNING: THIS APPLIANCE MUST BE EARTHED: (230V ONLY)

The mains lead is coloured Green and Yellow - Earth, Blue – Neutral and Brown – Live.

As these colours may not correspond with the coloured markings identifying the terminals in your plug, proceed as follows:

The wire which is coloured green and yellow must be connected to the terminal in your plug marked with the letter 'E' or by the earth symbol  or coloured green or green and yellow.

The wire which is coloured blue must be connected to the terminal which is marked with the letter 'N' or coloured black or blue.

The wire which is coloured brown must be connected to the terminal which is marked with the letter 'L' or coloured red or brown.

WARNING: THIS APPLIANCE MUST BE EARTHED: (110V ONLY)

The mains lead is coloured Green and Yellow - Earth, Blue – Neutral and Brown – Live.

As these colours may not correspond with the coloured markings identifying the terminals in your plug, proceed as follows:

The wire which is coloured green and yellow must be connected to the terminal in your plug marked with the letter 'E' or by the earth symbol  or coloured green or green and yellow.

The wire which is coloured blue must be connected to the terminal which is marked with the letter 'N' or coloured black or blue.

The wire which is coloured brown must be connected to the terminal which is marked with the letter 'L' or coloured red or brown.

EXTENSION LEAD CHART:

Extension lead sizes shown assure a voltage drop of not more than 5% at rated load of tool.

Ampere rating (on Name plate)	3	6	10	13
Extension cable length (Metres)	Wire Size mm ²			
7.5	0.75	0.75	1.0	1.25
15	0.75	0.75	1.0	1.5
22.5	0.75	0.75	1.0	1.5
30	0.75	0.75	1.25	1.5
45	0.75	0.75	1.5	2.5

IMPORTANT: A residual current circuit breaker (RCD) must be used when pumping from ponds or swimming pools and is recommended for all applications.

Draper Stock No.59779.

GENERAL SAFETY INSTRUCTIONS FOR POWER TOOLS

WARNING:

Please read the following instructions carefully, failure to do so could lead to serious personal injury. When using electric tools, basic safety precautions, including the following, should always be followed to reduce the risk of fire, electric shock and personal injury. Read all these instructions before operating this product and save these instructions.

IMPORTANT:

Draper Tools Limited recommends that this machine should not be modified or used for any application other than that for which it was designed. If you are unsure of its relative applications do not hesitate to contact us in writing and we will advise you.

1. KNOW YOUR POWER TOOL

Read and understand the owner's manual and labels affixed to the tool. Learn its application and limitations as well as the specific potential hazards peculiar to this tool.

2. KEEP WORK AREA CLEAN

Cluttered areas and benches invite accidents. Floors must not be slippery due to oil or sawdust.

3. AVOID DANGEROUS ENVIRONMENTS

Do not use power tools in damp or wet locations, or expose them to rain. Keep work area well lit. Provide adequate space surrounding the work area. Do not use in environments with a potentially explosive atmosphere.

4. KEEP CHILDREN AWAY

All visitors should be kept a safe distance from work area.

5. STORED TOOLS

When not being used, all tools should be stored in a dry, locked cupboard and out of the reach of children.

6. WEAR PROPER CLOTHING

Do not wear loose clothing, neckties or jewellery (rings, wristwatches) to catch in moving parts. NONSLIP footwear is recommended. Wear protective hair covering to contain long hair. Roll long sleeves above the elbow.

7. USE SAFETY GOGGLES (Head Protection)

Wear CE approved safety goggles at all times. Normal spectacles only have impact resistant lenses, they are NOT safety glasses. Also, use face or dust mask if application is dusty and ear protectors (plugs or muffs) during extended periods of operation.

8. NOISE LEVELS

Some types of machines may have high noise levels when working. In such cases ear protection must be worn.

9. VIBRATION LEVELS

Hand held power tools produce different vibration levels. You should always refer to the specifications and relevant Health and Safety guide.

10. DUST EXTRACTION

If your tool is fitted with a dust extraction fitting, always ensure that it is connected and being used with a dust extractor. Vacuum cleaners can be used if suitable for the material being extracted.

11. PROTECT YOURSELF FROM ELECTRIC SHOCK

When working with power tools, avoid contact with any earthed items (e.g. pipes, radiators, hobs and refrigerators, etc.). If you are using a power tool in extreme conditions (e.g. high humidity or generating metal dust), always use an RCD (residual current device) at the power socket.

12. STAY ALERT

Always watch what you are doing and use common sense. Do not operate a power tool when you are tired or under the influence of alcohol or drugs.

13. WHEN WORKING OUT OF DOORS

Only use extension leads designed for that purpose.

14. ACCESS TO MAINS SOCKET

If a stationary machine is fitted with a moulded plug and cable, the machine should not be positioned so that access to the mains socket is restricted.

15. DISCONNECT POWER TO THE TOOL

When not in use, before servicing and when changing accessories such as cutters, etc.

16. AVOID ACCIDENTAL STARTING

Make sure the switch is in the OFF position before plugging the machine into the power supply.

17. NEVER LEAVE MACHINE RUNNING UNATTENDED

Turn power off. Do not leave machine until it comes to a complete stop.

18. DO NOT ABUSE THE CORD

Never carry the tool by the power cable or pull it from the socket. Keep the power cable away from heat, oil and sharp edges. If the supply cord is damaged, it must be replaced by the manufacturer or its service agent or a similarly qualified person in order to avoid hazard.

19. NEVER STAND ON TOOL

Serious injury could occur if the tool is tipped or if the cutting tool is accidentally contacted. Do not store materials above or near the tool, so that it is necessary to stand on the tool to reach them.

20. CHECK DAMAGED PARTS

Before further use of the tool, a guard or other part that is damaged should be carefully checked to determine that it will operate properly and perform its intended function. Check for alignment of moving parts, free running of moving parts, breakage of parts, mounting and any other conditions that may affect its operation. A guard or other part that is damaged should be repaired properly or replaced by an authorized service centre unless otherwise indicated in this instruction manual. Have defective switches replaced by an authorized service facility. Do not use the tool if the switch does not turn it on and off.

21. KEEP GUARDS IN PLACE

And in working order.

22. MAINTAIN TOOLS WITH CARE

Keep tools sharp and clean for the best and safest performance. Follow instructions for lubricating and changing accessories. All extension cables must be checked at regular intervals and replaced if damaged. Always keep the hand grips on the tool clean, dry and free of oil and grease.

23. USE RECOMMENDED ACCESSORIES

Consult the owners manual for recommended accessories. Follow the instructions that accompany the accessories. The use of improper accessories may cause hazards.

24. REMOVE ADJUSTING KEYS AND WRENCHES

Form a habit of checking to see that keys and adjusting wrenches are removed from the tool before turning it on.

25. SECURE WORK

Use clamps or a vice to hold work. This frees both hands to operate the tool.

26. DO NOT OVERREACH

Keep proper footing and balance at all times.

27. USE RIGHT TOOL

Do not force the tool or attachment to do a job for which it was not designed.

28. DO NOT FORCE TOOL

It will do the job better and safer at the rate for which it was designed.

29. DIRECTION OF FEED

Feed work into a blade or cutter against the direction of rotation of the blade or cutter only.

30. WHEN DRILLING OR SCREWING INTO WALLS

Always make sure there is no danger of hitting any hidden power cables, water or gas pipes in the wall.

31. HAVE YOUR TOOL REPAIRED BY A QUALIFIED PERSON

This electric tool is in accordance with the relevant safety requirements. Repairs should only be carried out by qualified persons using original spare parts, otherwise this may result in considerable danger to the user.

IMPORTANT NOTE:

Residual Risk. Although the safety instructions and operating manuals for our tools contain extensive instructions on safe working with power tools, every power tool involves a certain residual risk which can not be completely excluded by safety mechanisms. Power tools must therefore always be operated with caution!



ADDITIONAL SAFETY RULES FOR SUBMERSIBLE WATER PUMP

1. When carrying or lifting the water pump always use the transport handle, do not carry or lift using the power cable or float switch cable.
2. Before connecting to the power supply:
 - A residual current circuit breaker (RCD) must be used for all applications (Draper Stock No.57779).
 - The electrical supply should be the same as that stated on the rating plate.
3. Submersible water pumps should always be transported, stored, and submersed vertically.
4. Always ensure that hands are dry when connecting and disconnecting the power supply.
5. Never operate the pump below the minimum water level (see specifications).
6. The area being pumped should be kept clear, and nobody should enter area while pump is operating.



IMPORTANT: PLEASE READ BEFORE USE

THE FOLLOWING ADDITIONAL INSTRUCTIONS MUST BE FOLLOWED AT ALL TIMES. FAILURE TO DO SO COULD INVALIDATE THE GUARANTEE OF THIS SUBMERSIBLE WATER PUMP.

1. The float switch must be clamped in position using cable clamp recess (see instruction manual page 9, fig.7).
2. Clean water pumps are not suitable for use in dirty water.
3. Dirty water pumps are only suitable for pumping suspended solids up to 30mm in diameter.
4. When using clean water pumps in a pond or where there is gravel, mud, leaves etc.
NOTE: The pump, should be suspended using a rope or chain or stood on a brick to prevent any gravel etc., being sucked into the pump.
5. If pump fails to operate, disconnect from mains supply. Remove output elbow and turn the impellor using a screwdriver or finger. Check for obstruction in the impellor, i.e. stones/gravel etc.
6. The float switch fitted to this pump is not suitable for continuous use as an on/off switch.
IMPORTANT: ANY PUMP RETURNED TO DRAPER TOOLS UNDER WARRANTY MUST BE CLEAN. IF A PUMP IS RECEIVED THAT IS NOT, OR HAS NOT BEEN CLEANED, IT WILL BE RETURNED TO YOU AT YOUR COST.

GETTING TO KNOW YOUR SUBMERSIBLE WATER PUMP



- ① Automatic cut off float switch (not fitted to SWP120).
- ② BS Approved 3 pin non-rewireable moulded plug and cable (not fitted to 110V models).
- ③ Transport handle.
- ④ Float switch cable clamp presses.
- ⑤ Rating label.
- ⑥ Outlet.
- ⑦ Filter base plate.
- ⑧ Hose adaptor.

UNPACKING: After removing the packing material, make sure the product is in perfect condition and that there are no visible damaged parts. If in doubt, do not use the Submersible Water Pump and contact the dealer from whom it was purchased. The packaging materials (plastic bags, polystyrene etc.,) must be disposed of in an appropriate refuse collection container. These materials must not be left within the reach of children as they are potential sources of danger.

OPERATION AND USE

The pump must be fully submersed before the power is switched on. Do not turn on when dry (fig. 1).

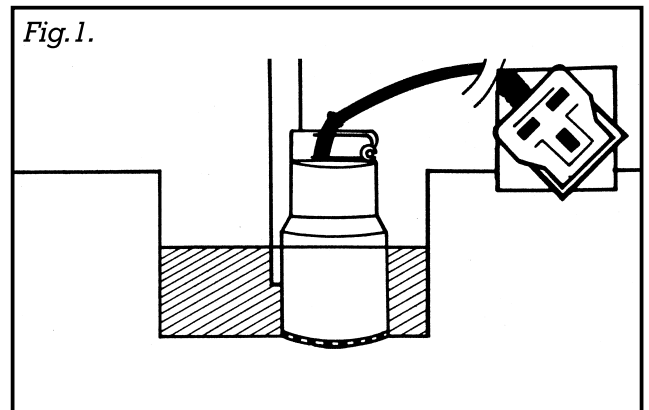

When submersing or lifting the pump it may be necessary to use a rope or chain, this must only be attached to the transport handle (fig.2).

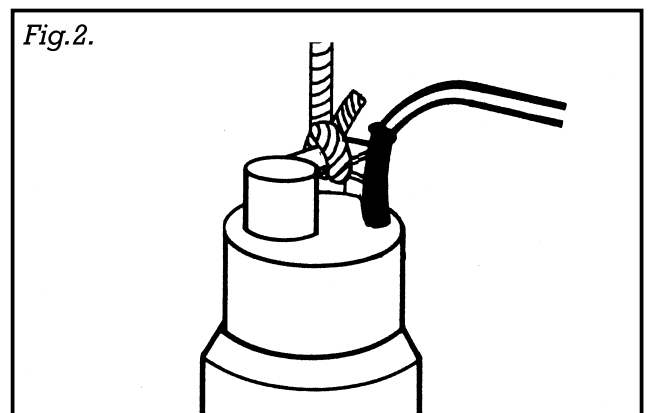

If pumping water from a sandy or muddy floor bed, the pump can be suspended using a rope or chain (not supplied) fixed to the handle. Do not use any of the electric cables for this purpose (fig.3).

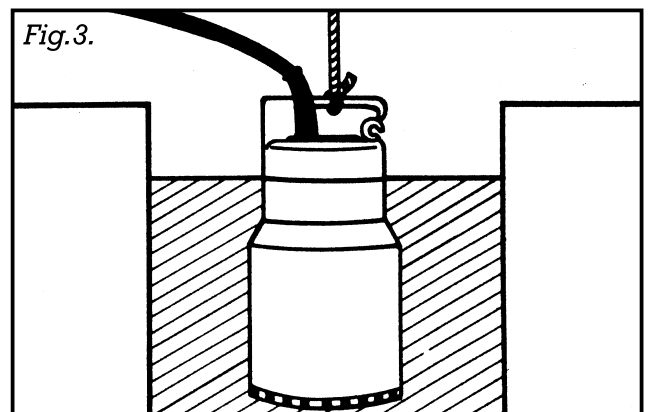

When pumping flood water from a room or cellar, installation of the pump should be in a drain well (if possible). The dimensions should allow easy movement of the float switch (fig.4). This will allow the pump to remove the water below the floor level (fig.5).

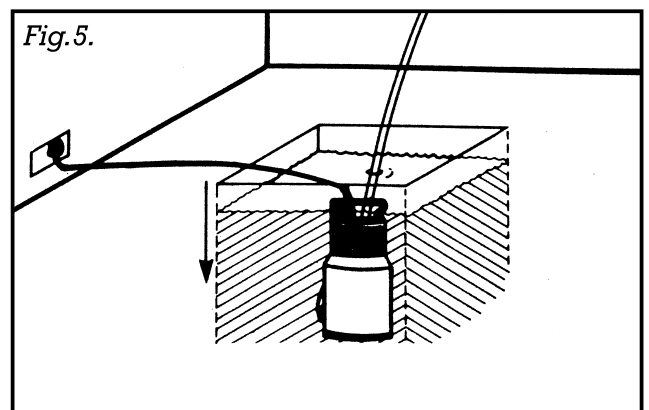
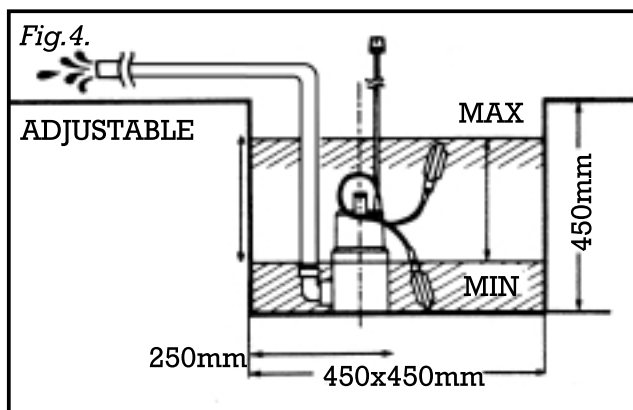

OPERATION AND USE

OPERATION (Fig.6.):
An automatic float switch item (A) is fitted to the pump, this enables the pump to switch off automatically when the water has reached the minimum level.

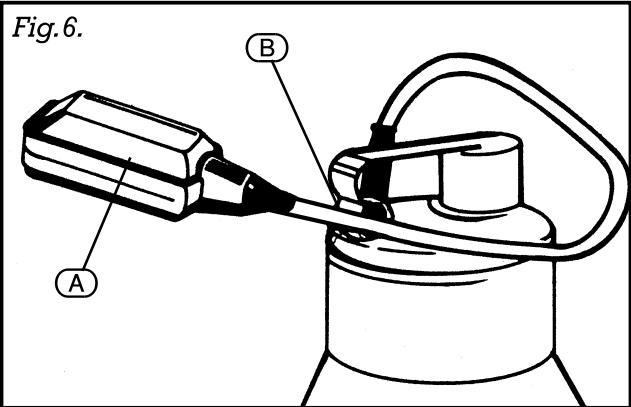

As the water level drops the float switch will fall with the water level (figs.7 and 8).

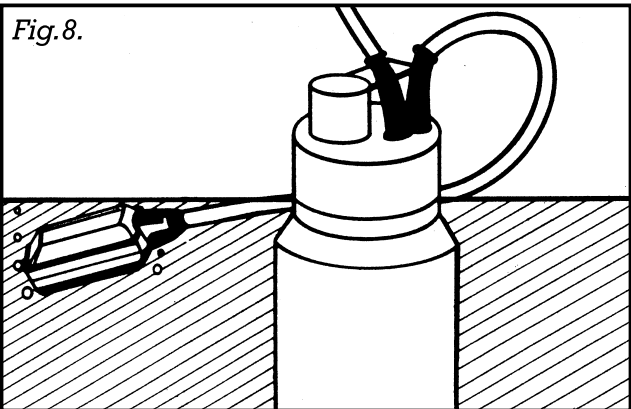
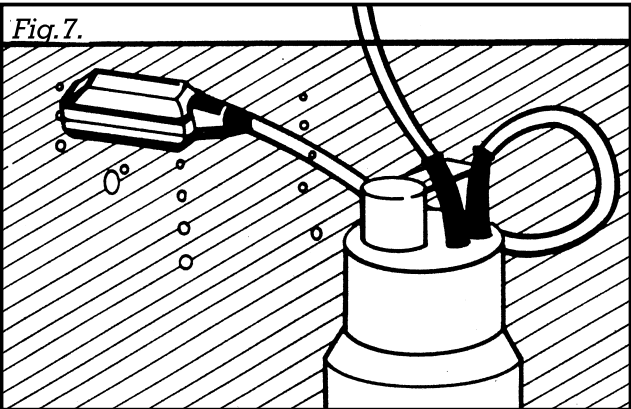

When the float switch reaches the minimum level it will automatically switch the pump off (fig.9).

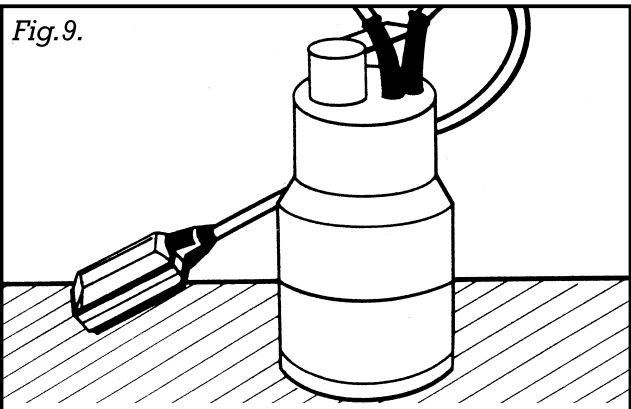

OPERATION AND USE

The float switch can be set to a specific cut off level by increasing or decreasing the length of cable (I) between the cable clamp recess (D) and float switch (A) (figs.7 and 11).

(An automatic float switch is not fitted to Model No.SWP120)

The motor is protected by a thermal overload switch, If the motor should over heat it will automatically switch off the pump. After it has cooled the pump will automatically restart (approximately 15 minutes)

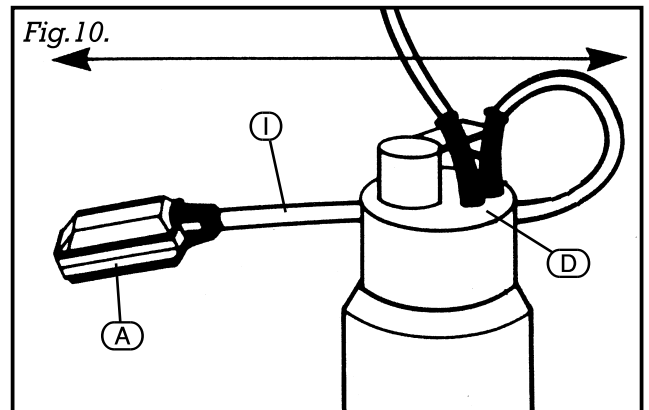

MAINTENANCE

WARNING: FOR YOUR OWN SAFETY, REMOVE PLUG FROM POWER SUPPLY BEFORE MAINTAINING YOUR SUBMERSIBLE WATER PUMP.

If the filter becomes blocked or obstructed, remove base plate (G) (fig 11). Remove any obstruction clean and refit base plate.

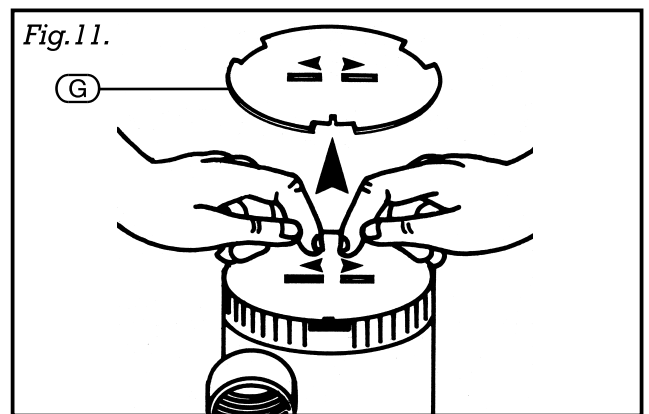

Effective cleaning is obtained by using a water jet (fig.12). If the pump is used in salt water it must be rinsed thoroughly in fresh water after use.

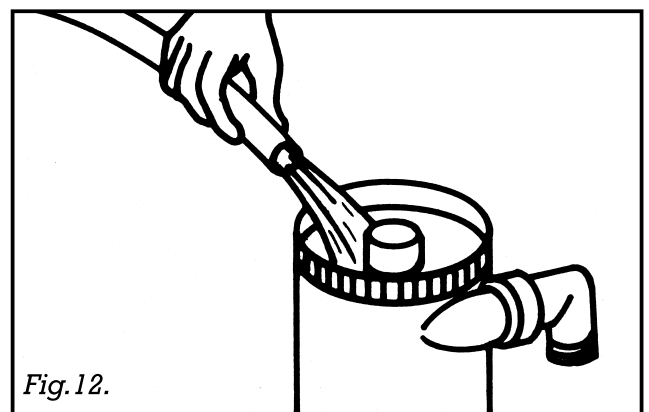

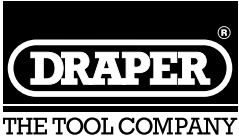

OPTIONAL ACCESSORIES

LAYFLAT HOSE:

Stock No:- 36919
Part No:- ASWP1
Description:- Hobby/DIY Hose
Size:- 25mm I.D.
Length:- 5m.

Stock No:- 36946
Part No:- ASWP3
Description:- Heavy Duty Hose
Size:- 25mm I.D.
Length:- 10m.

Stock No:- 36947
Part No:- ASWP4
Description:- Heavy Duty Hose
Size:- 32mm I.D.
Length:- 10m.

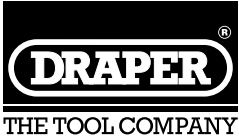

TROUBLE SHOOTING

WARNING: FOR YOUR OWN SAFETY, TURN “OFF” AND REMOVE PLUG FROM POWER SUPPLY BEFORE TROUBLE SHOOTING YOUR SUBMERSIBLE WATER PUMP.

TROUBLE	PROBABLE CAUSE	REMEDY
No power	Faulty power supply. Power supply fuse blown. Residual current circuit breaker tripped.	This should be replaced immediately by a qualified person. Replace fuse. Check and reset.
Pump running but not delivering water	Water level under the minimum pumping level (see specifications). Filter inlet clogged. Outlet tube clogged. Hose flat	Raise water level (where possible). Clean filter. Remove the tube and clear obstruction. Re-install the pump but at an angle, when submerged, and gently shake while outlet tube is open. Switch on/off repeatedly.
Pump stops running, due to thermal overload coming into operation.	<ol style="list-style-type: none"> 1. Voltage supply different to rating plate. 2. A solid has jammed in pump. 3. The pump is operating in hot water. 4. The pump ran dry (in automatic version this could be caused by restart). 	Remove plug from power supply. Remove obstruction. Wait for pump to cool and then restart. Wait for pump to cool and then float switch).

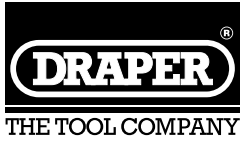

<h1>NOTES</h1>

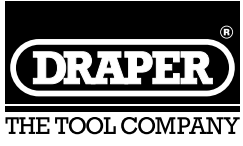

<h1>NOTES</h1>

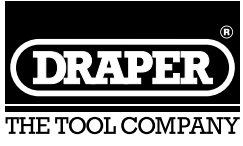

<h1>NOTES</h1>

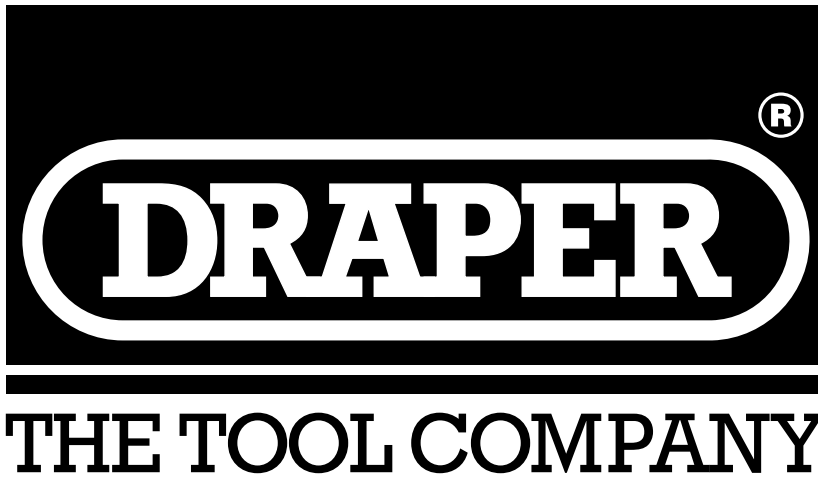

DRAPER TOOLS LIMITED,

Hursley Road, Chandler's Ford, Eastleigh, Hants. SO53 1YF. U.K.

Helpline: (023) 8049 4344.

Sales Desk: (023) 8049 4333.

General Enquiries: (023) 8026 6355.

Fax: (023) 8026 0784.



<http://www.draper.co.uk>

e-mail: sales@draper.co.uk

YOUR DRAPER STOCKIST

©Published by Draper Tools Ltd.
No part of this publication may be reproduced,
stored in a retrieval system or transmitted in
any form or by any means, electronic, mechanical
photocopying, recording or otherwise without prior
permission in writing from Draper Tools Ltd.