



electronics line uk

# DIGI-VIEW4PRO / DIGI-VIEW4PRON



## User Manual

Revision 1.8  
Date: April 10, 2008

Introduction .....	6
Package Contents.....	6
Specifications.....	7
Three Steps to Install Surveillance Kit.....	8
Installation and Exchange of HDD .....	9
Upload PC Player Program.....	10
DVR Front Panel.....	12
DVR Rear Panel .....	14
Video Input / Output Connection .....	15
Sensor Installation .....	16
Alarm Installation .....	17
Power On DVR .....	18
Initial Screen.....	18
Live View .....	18
Display Mode.....	20
QUAD View.....	20
Picture in Picture (PIP) .....	20
Sequence View.....	21
Single Channel View.....	21
Record .....	22
Playback.....	23
Time Search .....	23
Event Search.....	24
Playback Operation .....	25
Advanced Playback Operation .....	25
DVR Menu and Setup .....	26
Camera Video Setup .....	26
Title Setup .....	27
Color Setup.....	27
Motion Detection.....	28
Status Select.....	29
NTSC/PAL Setup .....	29
Record Setup.....	30
Record Mode Setup.....	31
Continuous Record.....	31
Recording Duration.....	32

Motion Record .....	34
Alarm Record.....	35
Backup Setup .....	35
PC LINK .....	36
FLASH DISK.....	37
TCP/IP SETUP (Only for DIGI-VIEW4PRON) .....	38
Peripheral Setup .....	41
Buzzer Setup.....	41
Alarm Setup.....	42
Sequence Setup .....	43
Password Setup .....	44
VGA Setup (FOR VGA MODEL ONLY).....	45
PTZ Setup .....	46
Date Time Setup .....	46
Hard Disk Setup.....	47
Hard Disk Information .....	47
HDD Format .....	48
HDD Record Mode .....	48
Factory Setup .....	49
PC Player Program.....	51
Install PC Player Program .....	51
Connect DVR to Computer .....	51
Run PC Player Program .....	52
Interface and Operation Indication.....	52
Open Video.....	52
Play Video .....	54
Audio and Volume .....	55
Save to JPG .....	55
Save to AVI .....	55
Turn On/Off Time and Channel Indications.....	56
Print Screen.....	56
Internet Operation (Using IE Browser; ONLY FOR DIGI-VIEW4PRON) .....	57
Live Video.....	58
Capture and Record .....	58
Playback.....	58
Event List.....	59
Network Setup .....	60

Server .....	60
Network .....	61
DVR Setup.....	63
System .....	63
Record .....	65
Auto Log Setup .....	66
Auto Log Enable .....	67
Auto Log List.....	67
Central Management System (ONLY FOR DIGI-VIEW4PRON) .....	68
Basic Controls .....	68
DVR Management Panel .....	69
Recording and Capturing Panel.....	70
Configuration Panel .....	70
Network Setup.....	70
DVR Setup.....	73
Event Log .....	79
CMS Setup .....	80
About .....	80
PTZ Panel.....	80
Playback.....	80
DVR Finder (ONLY FOR DIGI-VIEW4PRON).....	82
DDNS (ONLY FOR DIGI-VIEW4PRON) .....	83
Appendix.....	87
Troubleshooting.....	87

## **Regulatory**

### **FCC Certification**

This equipment has been tested and found to comply with the limits for a class A digital device, pursuant to Part 15 of the FCC rules. These limits are designed to provide reasonable protection against harmful interference when the equipment is operated in a commercial environment. This equipment generates, uses, and can radiate radio frequency energy and, if not installed and used in accordance with the instruction manual, may cause harmful interference to radio communications. Operation of this equipment in a residential area is likely to cause harmful interference in which case the user will be required to correct the interference at their own expense.

### **CE Mark**

This product is marked with the CE symbol and indicates compliance with all applicable EEC directives.

## Introduction

This system is a professional and easy-installation surveillance and security system designed for small offices, restaurants, and house owners. Connect any four DC 12V powered CCTV cameras to the DVR (Digital Video Recorder) and enjoy various functions, such as recording, retrieving, and network monitoring (only available for Network Model) video images.

The professional DVR implements the latest smart recording technology, which enables the DVR to determine the incoming signals of each channel/camera for recording purpose. If there is no video signal coming from one channel, the DVR does not record that channel's video; therefore, it does not waste HDD space. The DVR also allows users to enable or disable recording of each channel. Its pre-recording function is capable of catching the entire events without missing how the events are happening.

Through USB devices, the DVR provides very convenient methods to back up video streams to USB flash disks and PCs (not compatible with Apple systems).

## Package Contents

CCTV Surveillance System Kit	DVR / Network DVR x1 IR Remote Control x1 DVR Power Transformer x1 DVR Video Output Cable x1 BNC To RCA Connector x1 USB Cable x1 CD x1 Color, Waterproof, Day & Night Cameras x4 50 feet DIY cable x4  (Items are subject to change)
------------------------------	---

# Specifications

Item No.	DIGI-VIEW4PRO / DIGI-VIEW4PRON
Video Input Format	NTSC / PAL
Video Input Channel	4CH. Composite
Video Output Channel	2CH. BNC & VGA (Optional)
Audio Input	2CH. In, 2CH. Out; RCA
Motion Detector	Yes
Remote Control Interface	Yes
USB Serial Port (PC-Link)	Yes
Built-in Buzzer	Yes
Display Mode	Each, Quad, PIP, Sequence
Display Frame	NTSC 120 fps PAL 100 fps
Recording Frame Rate (quad mode)	NTSC Max. 30 fps PAL Max. 25 fps
Recording Frame Rate (each mode)	NTSC Max. 7.5 fps PAL Max. 6.25 fps
Recording Mode	Continuous, Motion Detection, and Alarm Event (All modes can be triggered by schedule.)
Resolution (Display)	NTSC 720 x 480 PAL 725 x 576
Resolution (Recording)	NTSC 704 x 480 PAL 704 x 576
Compression Format	Modified M-JPEG / MPEG4
	H.244 Video Compression (For H.264 DVR Model Only)
HDD	One HDD Rack
Search Mode	Time, Event (Motion, Alarm, Video Loss)
Network Protocol(DIGI-VIEW4PRON Only)	TCP/IP
Ethernet	RJ-45 10M / 100M
Browser	IE 5.0 or above version
OS	Windows 2000 / XP / Vista
Recording Software	Yes
Video Adjustment	Yes
Watch-dog Function	Auto Recovery Capability After Power Outage
Dimension	290mm x 300mm x 56mm
Weight (Without HDD)	3.8kg

Specifications are subject to change without prior notice.

# Three Steps to Install Surveillance Kit

## 1. DVR Set Up

- a. Decide where to locate the DVR (Please locate it close to TV or monitor if possible)
- a. Install HDD if it is necessary (Please refer to **Installation and Exchange of HDD**)
- b. Connect DVR to TV/Monitor (Please refer to **Video Output Connection**)

## 2. Camera Setup

- a. Decide where to install camera and fix mounting bracket on the ceiling or roof
- b. Connect Camera to DVR (Please refer to **Video Input Connection**)

## 3. DVR Setting

- a. Determine and setup Video Format
  - i. Europe Region → PAL
  - ii. USA → NTSCPlease refer to **NTSC/PAL Setup Sub Menu**.
- b. Upload PC Player program. Please refer to **Upload PC Player Program**.



## Installation and Exchange of HDD

1. Open the lid on the top cover.

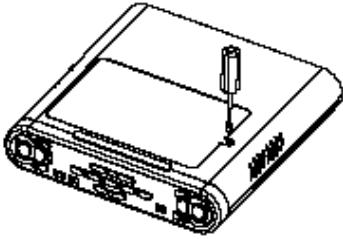

2. Loosen the screws on the HDD rack.

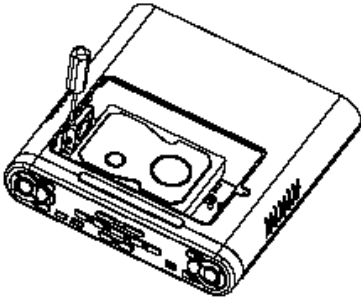

3. Connect power cable and transmission bus to the hard drive.

4. HDD rack will rise. Put the hard drive on the rack and screw it to HDD rack.

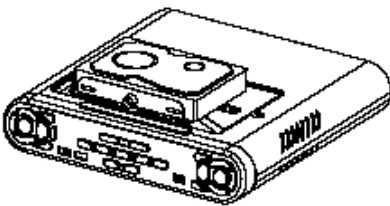

5. Push HDD rack to the bottom and screw it up.

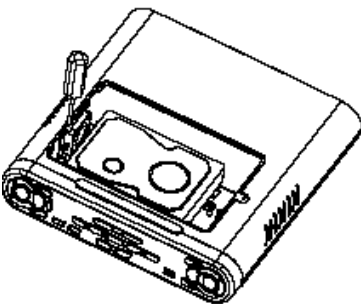

6. Close the lid on the top cover.

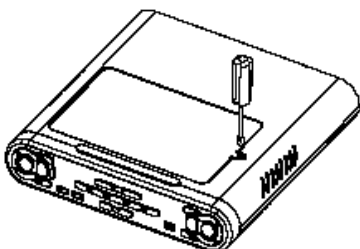

Note: Please leave some space between the fan and the HDD for air circulation.

## Upload PC Player Program

After first installation of HDD or changing a new HDD, we need to upload PC Player Program to DVR. DVR will automatically copy the PC Player to USB flash devices when backing up through USB. This leads to review video anytime anywhere.

1. Turn on the DVR by switching on the power on the back panel.

2. Plug USB flash drive device to  plug on the DVR front panel.



3. Go to Factory SETUP menu.
4. In Factory Setup, highlight USB FORMAT, press “+” or “-” to change NO to YES. And press “↵” to format USB.

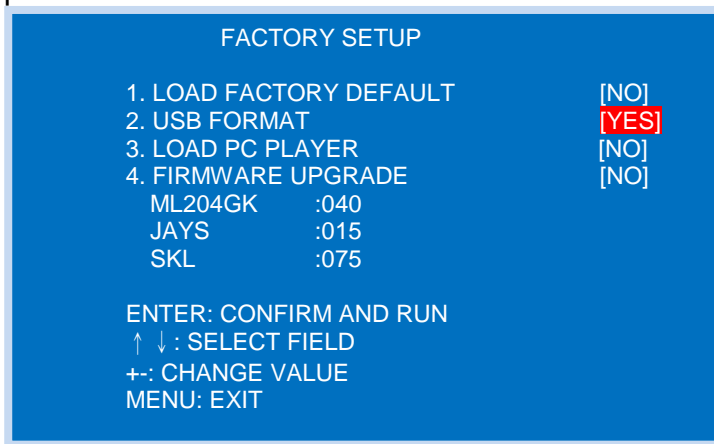

5. Remove the USB flash drive from DVR and plug it to PC.

**Note: Apple System is not applicable**

6. PC automatically detects the USB device. Please open the file window inside USB flash drive and there are several files. Please delete “**PLAYER.PAK**” in the USB flash drive.

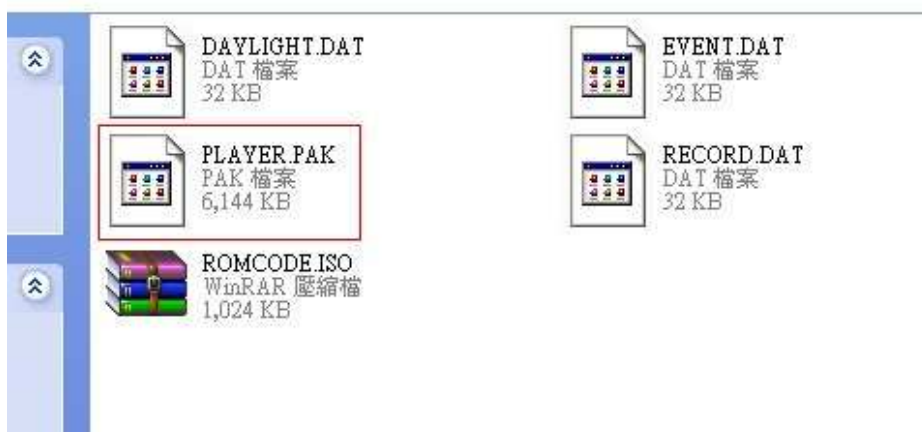

7. Insert the provided CD to PC, and open the file window. In this disc, there is a file, called “**PLAYER.PAK**”. Please copy the file, “**PLAYER.PAK**”, and paste it to the flash drive.

8. Properly remove the flash drive from the PC and plug it to  port on the DVR front panel.

9. In Factory Setup, highlight Load PC Player and press “+” or “-“ to change No to Yes.

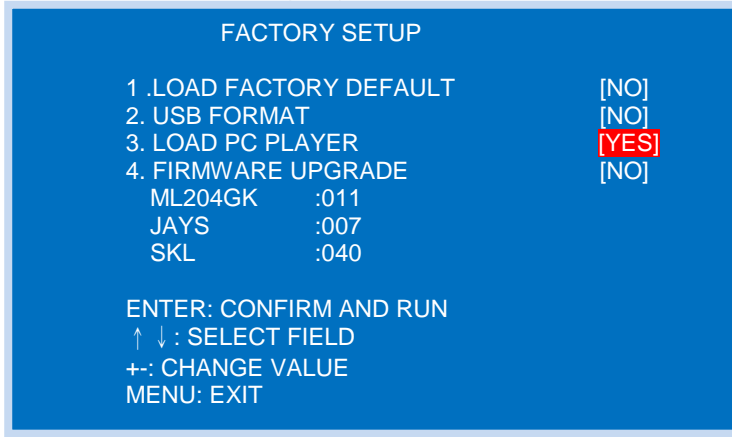









10. Press “←” to upload PC Player Program to DVR.

# DVR Front Panel

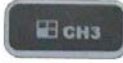

I.	
	Record Video
	Quick Backup Video
	Playback Video
	Reverse Playback Video
	Fast Forward Video
	Rewind Playback Video
	Pause Playback Video
	Stop Playback Video
II.	
	Menu
	Key Lock (Press this button, the system configuration key pads will be locked. Users must enter password to activate system configuration key pads.)
	Channel 1
	Channel 2
	Channel 3
	Channel 4
	Quad View
	Picture in Picture Display
	Sequence Display
	USB Link to PC
	USB for Flash Drive
III.	
	Enter
	Infrared Receiver
	Up
	Down
	Left
	Right
	Adjust Value
	Adjust Value

## Keypad Mapping

Button	Number
 Stop	0
 Channel 1	1
 Channel 2	2
 Channel 3	3
 Channel 4	4
 Quad	5
 PIP	6
 Sequence	7
 Pause	8
 Reverse Playback	9

# DVR Rear Panel



Power Switch

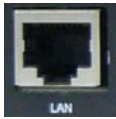

Internet Plug



Audio Input / Output



Video Output to Monitor / TV



Power Output for the Camera



Video Input for the Camera

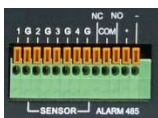

Alarm/Sensor/PTZ I/O Platform



VGA Output



DVR Main Power Input

# Video Input / Output Connection

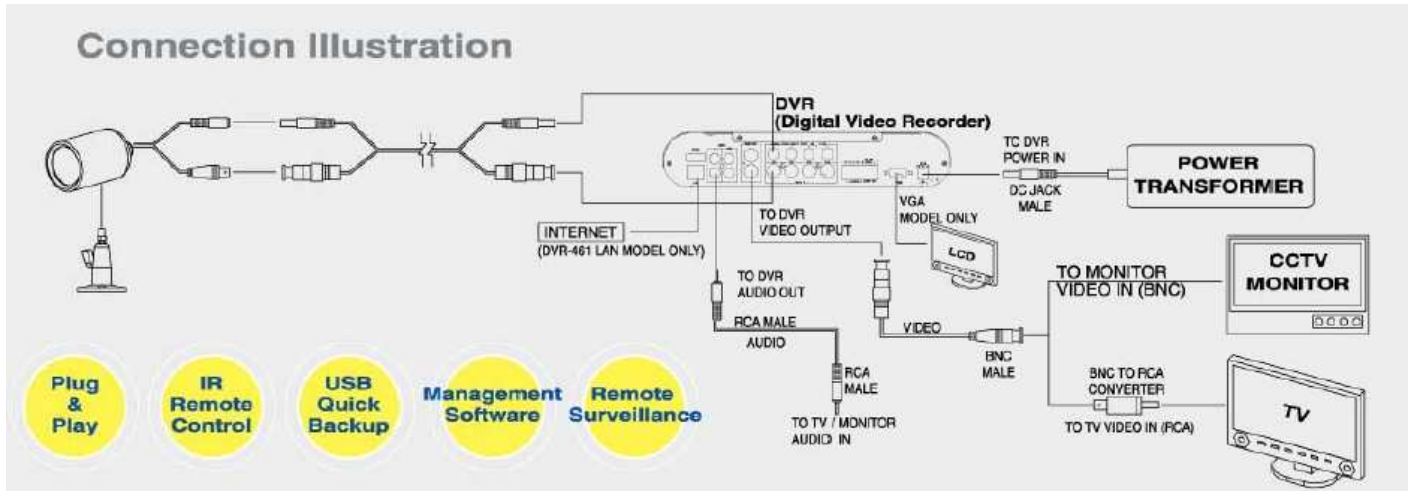

## Sensor Installation

The DVR has 4 sensor inputs, one for each channel. The sensor installation procedure is as the following:

- I. Connect the sensor signal line to the unit. The sensor signal terminal is on the DVR rear panel.
- II. Connect the sensor adaptor jack into the sensor, and plug in the power adaptor.

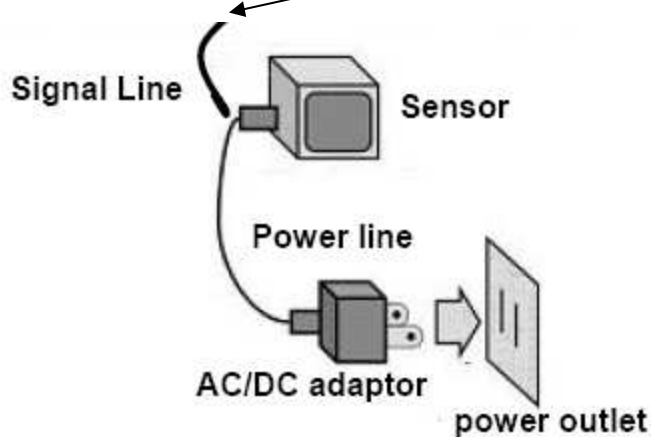
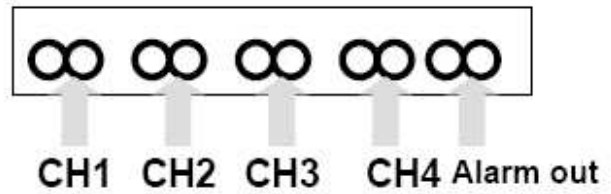
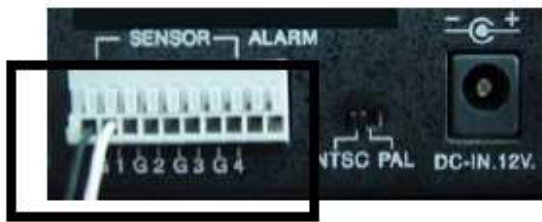



## Alarm Installation

The DVR includes one internal switch for sounding an alarm when any of the sensor inputs is activated. The switch is normally open and closed upon activation.

The circuitry is shown in the above figure. The alarm is installed as follows:

- I. The alarm requires a power supply, which is normally supplied with the alarm.
- II. Connect the alarm power line to the alarm switch terminal on the rear of the DVR.

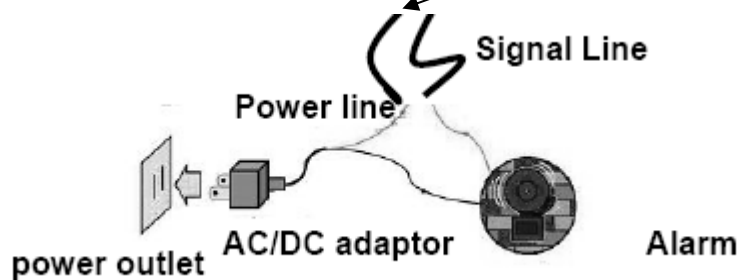
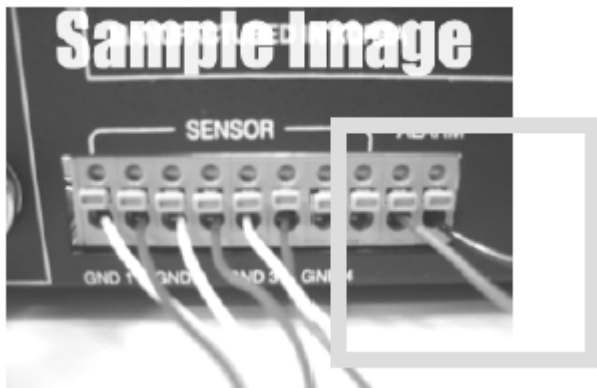

## Power On DVR

**NOTE:**

Factory default setting of video format (NTSC / PAL) is in accordance of the importing country standard. If you are using this DVR in different video format standard areas, please adjust the format. To adjust format, please refer to “NTSC / PAL SETUP” section on Page 29.

### **Initial Screen**



Above message window appears on the monitor when DVR is turned on. After DVR has finished initializing, a quad live view is displayed on the screen. Key lock function is also activated. To disable the key lock, press the MENU button “” and enter the password. The default password is **0000**.

**NOTE:**

Please refer to the keypad match list on Page 13.

### **Live View**

QUAD Mode

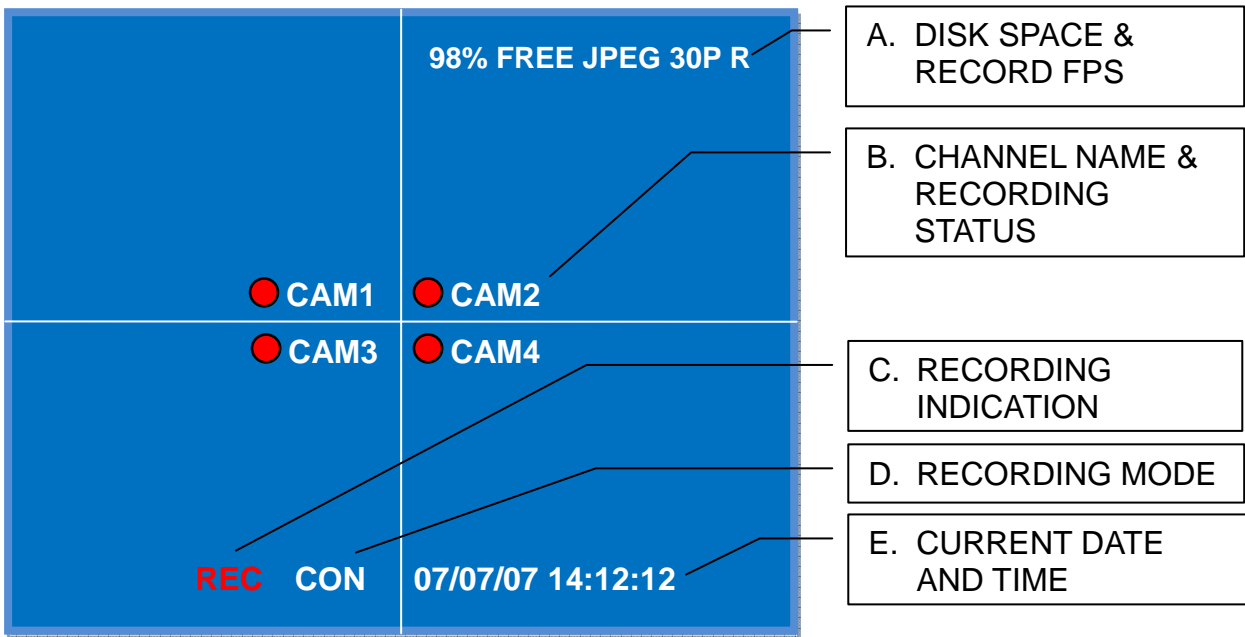

#### A. DISK SPACE & RECORD FPS

98% FREE means HDD is still 98% empty. The number keeps going down if DVR keeps recording. It shows 99% FREE when HDD is formatted. JPEG is the recording format. 30P indicates the recording frame rate, and DVR records 30 frames per second (fps). The very last R means RECYCLE mode, and it shows O if it is ONCE mode.

#### B. CHANNEL NAME & RECORDING STATUS

CAM2 is the name of this channel. A red dot appears when the channel is recording. Users can change the name of each channel. Please refer to "TITLE SETUP" on Page 27.

#### C. RECORDING INDICATION

REC appears when DVR is recording any channel.

#### D. RECORDING MODE

It indicates which recording mode is working. CON means Continuous Mode. MON stands for Motion Detection Mode, and ALM means Alarm Event Mode. Users can change the setting of each mode and modify the schedule of recording for each mode. Please refer to "RECORD SETUP" for "RECORD MODE", "CONTINUOUS SETUP", "MOTION SETUP", and "ALARM SETUP" on Page 30.

#### E. CURRENT DATE AND TIME

It indicates current date and time. For adjustment, please refer to "DATE TIME SETUP" on Page 46.

## Display Mode

DVR provides four different live view modes: QUAD View, Picture in Picture, Sequence View, and Single Channel View. Press Channel buttons, QUAD, PIP, and SEQ buttons on the front panel to change the display mode.

### QUAD View

Quad View is the default view mode when DVR is turned on.

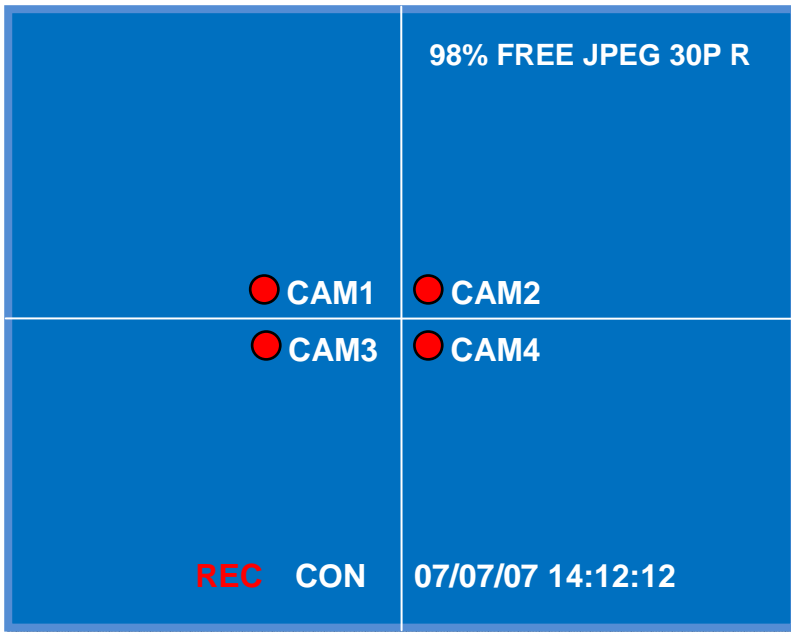

### Picture in Picture (PIP)

PIP Mode allows users to view the primary channel and other three channels at the same time. To select the primary channel, press “+” or “-” buttons on the front panel.

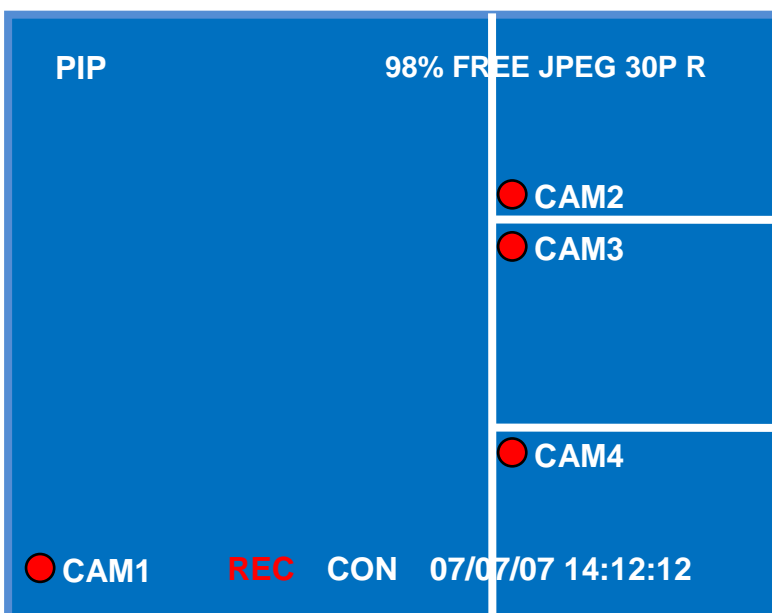

## Sequence View

In Sequence View, the screen displays through available channels at a certain interval. Please refer to "SEQUENCE SETUP" on Page 43.

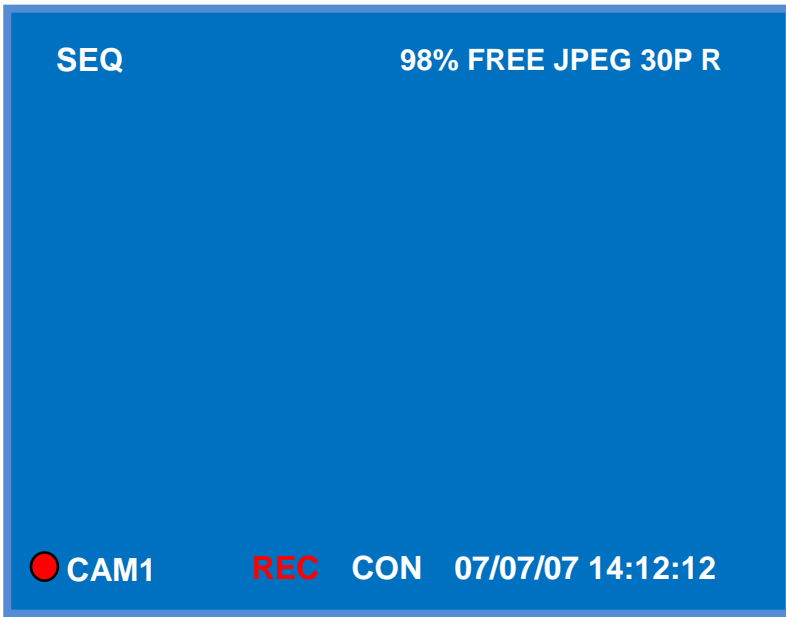

## Single Channel View

Single Channel View shows one channel constantly.

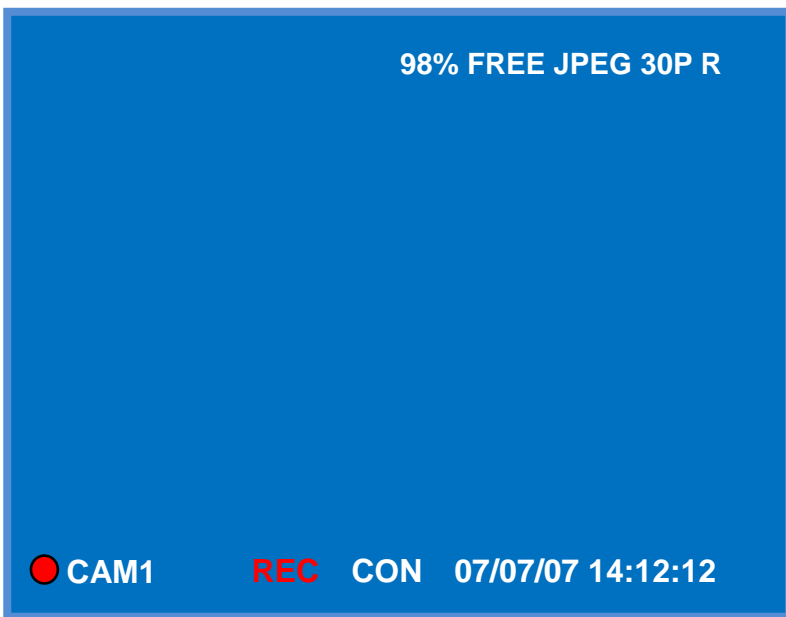

## Record

This DVR is equipped with an intelligent recording system, which automatically resumes previous recording setup and starts recording once the DVR is recovered from electricity blackout or rebooting. Default recording mode is continuous recording. To adjust record mode, please refer to “RECORD MODE SETUP” on Page 31.

Press “●” button on the front panel to start recording. If record mode is not set up, a message “SETUP RECORD” shows on the screen.

Press “■” on the front panel to stop recording. DVR will ask for the password to stop video recording. The default password is 0000. To set up password, please refer to “PASSWORD SETUP” on Page 44.

## Playback

Users can press “▶” button on the front panel to enter playback mode. Below picture appears on the screen when entering playback mode.

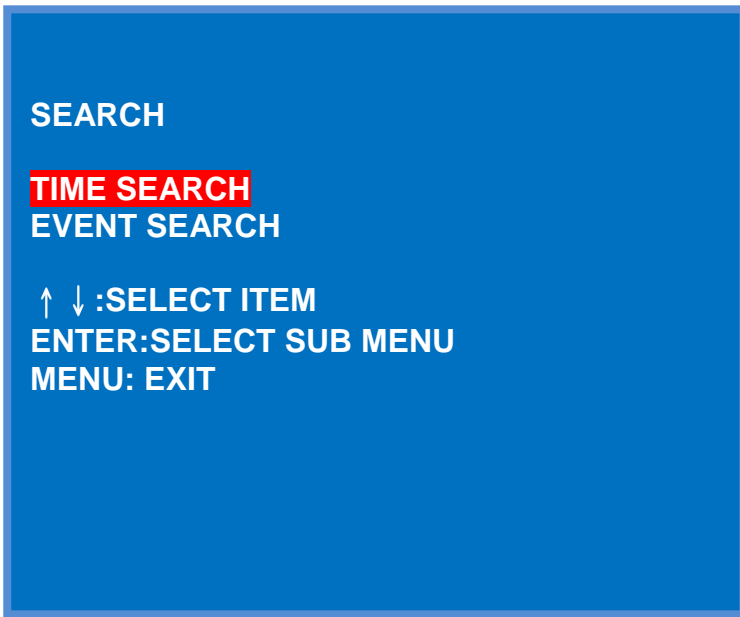

This DVR provides two playback search functions; they are “TIME SEARCH” and “EVENT SEARCH”. Use “↑” or “↓” key to select playback function and press “↵” to enter each function.

In playback mode, press “||” to pause. Then, press “QC” to activate Quick Copy function for backing up video to the flash drive. Quick Copy will back up two minute video from the time point, or backup the whole event.

### *Time Search*



BEGIN is the time the DVR starts to record. END is the time that the DVR stops recording.

Use “↑” and “↓” key to select year, month, day, hour, and minute. Use “+” or “-” key to cycle through all available values.

When the time is confirmed, press “←” to view the playback.

Press “■” to end the playback and return to LIVE VIEW.

Press “☰” (Menu Button) to start a new search.

Press “||” to pause the playback.

## Event Search

EVENT SEARCH			PAGE 001
	YY/MM/DD	HH/MM/SS	
000	07/08/11	11:15:20	M2
001	07/08/11	11:15:45	M2
002	07/08/11	11:17:02	M2
003	07/08/11	11:22:11	M2
004	07/08/11	11:33:12	L1
005	07/08/11	11:34:11	M2
006	07/08/11	11:35:55	A3

+-: SELECT ANOTHER PAGE  
↑ ↓ :SELECT FIELD  
ENTER: VIEW EVENT  
MENU: EXIT

A. PAGE NUMBER

B. EVENT LIST

Press “+” or “-” to go to other pages. Press “↑” or “↓” to select events, and use “←” to view the event.

### A. PAGE NUMBER

It represents the current page number. The DVR has a total of 143 pages.

### B. EVENT LIST

It shows events. Use “↑” or “↓” button on the front panel to select the event. Each event row shows the event time, event channel and event type. For example:

**002 07/08/11 11:17:02 represents Event 2, on 11:17:02 on August 11, 2007.**

**L1 means Video Loss happening on Channel 1.**

**M2 means Motion Detection triggered on Channel 2.**

**A3 means Alarm Event triggered on Channel 3.**

When the event is confirmed, press “←” to view the playback.

Press “■” to end the playback and return to LIVE VIEW.

Press “☰” (Menu Button) to start a new search.

Press “||” to pause the playback.

#### NOTE:

This DVR is capable of storing more than 1000 events. Event records are deleted if users format the HDD.



## **Playback Operation**

When starting playback, DVR now is in playback mode and displaying. This DVR provides different speeds of playback, fast backward, fast forward, and frame by frame play back.

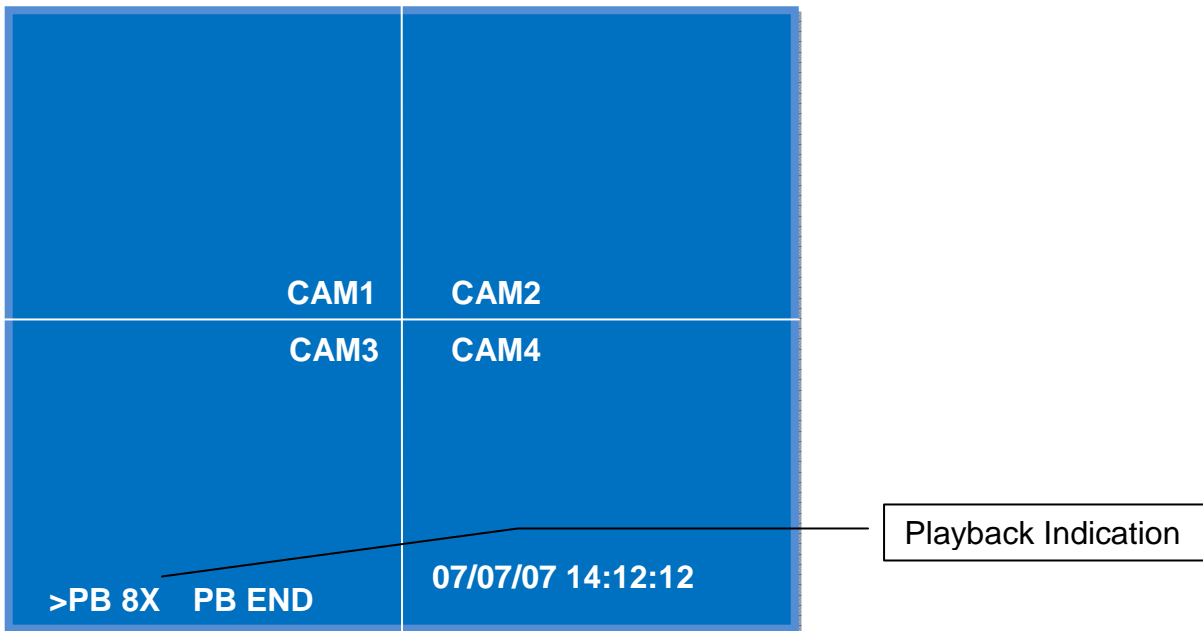

When in playback mode, the left lower screen shows the operation type:

>PB means playing forward, while <PB means rewind.

8X shows the playing speed. Users can press button “▶▶” (“◀◀”) to do fast forward (fast rewind) of the playback. Multiple press of the button can do fast forward (fast rewind) of the playback at different speeds; the speed order is x2 → x4 → x8 → x2 → x4 → x8 → x2.

When reaching the end of the video, it shows “PB END” next to the operation type.

## **Advanced Playback Operation**

This DVR provides an advanced playback function by playing back video stream **frame by frame** and **1/2 speed playback**.

### **1/2 speed playback**

A. Press **⏸**

B. Press “▶▶” to do 1/2 speed of playback. Or press “◀◀” to do 1/2 of rewinding playback.

### **Frame by frame playback**

Press “⏸”. Then press “⏸” again to do frame by frame playback.

To do rewind frame by frame, users must set the DVR in rewind play and press “⏸”. Then press “⏸” again to do frame by frame rewind.

## DVR Menu and Setup

Press “” (Menu Button) to access main menu.



Basic key indication:

Use “↑” and “↓” button to select each section. Press “←” to go to the section.

Press “” (Menu Button) to exit the last page or go to Live View mode. When exiting any sections, DVR will save the changes.

**NOTE:**

TCP/IT SETUP option is only available for LAN model DVR

### ***Camera Video Setup***

Under CAMERA VIDEO SETUP, users are allowed to name their cameras, to adjust video quality, to set up motion detection, to set up each camera recording option, to adjust video format and to set up each camera visibility in live view mode.

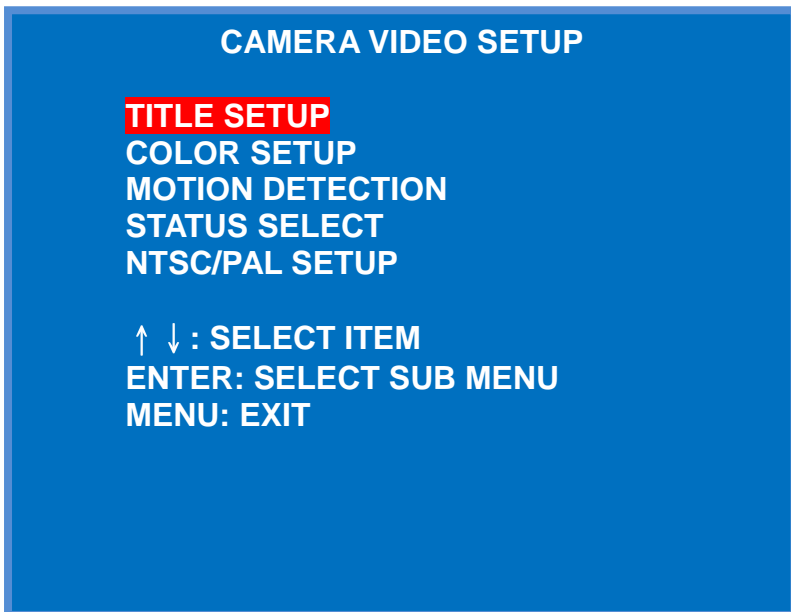

Press “↑” or “↓” button to choose each section. Use “←” button to access the section.

### Title Setup

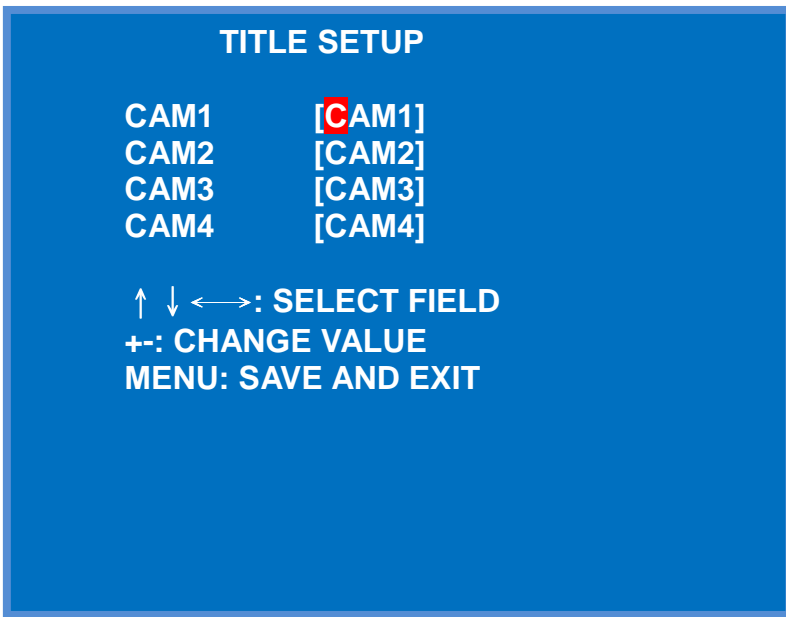

1. Use “↑”, “↓”, “→” or “←” button to select each character of cameras.
2. Press “+” or “-” button to cycle through available characters. (0~9, A~Z)
3. Each channel of camera can have four characters at maximum.
4. Press “” (Menu Button) to save changes and return to the previous page.

### Color Setup

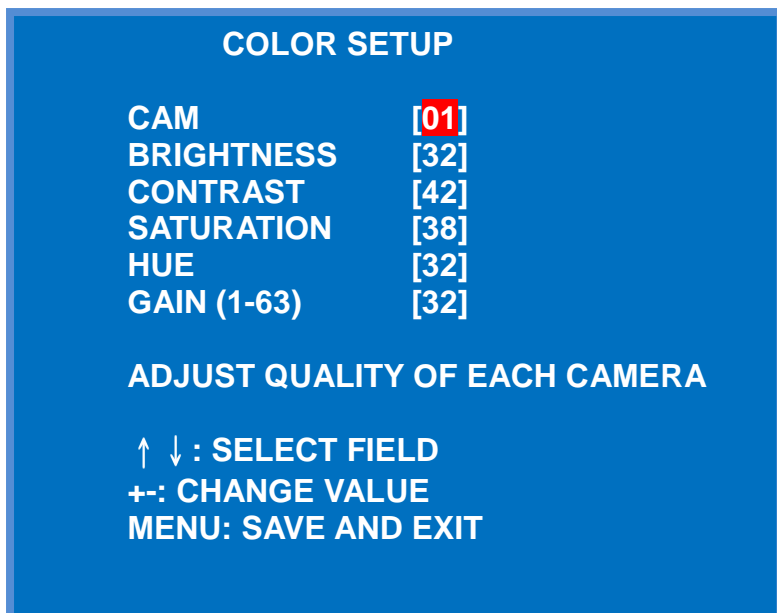

1. Highlight CAM first to choose camera channel. Press “+” or “-” to select each channel.
2. Use “↑” or “↓” button to each adjustable item and use “+” or “-” button to cycle through available values. (Note: 01 → Minimum ; 63 → Maximum)
3. Press “” (Menu Button) to save all changes and go to the previous page.

## Motion Detection

Under this section, users are allowed to adjust motion detection areas, sensitivity, and relay in DVR.

The relay serves as a terminal of external alarm to other electrical devices, which is to activate the alarm or the devices when motion is detected. For example, users may connect a buzzer alarm to DVR (I/O: Out). When motion is detected by DVR and relay is on, the buzzer alarm is triggered

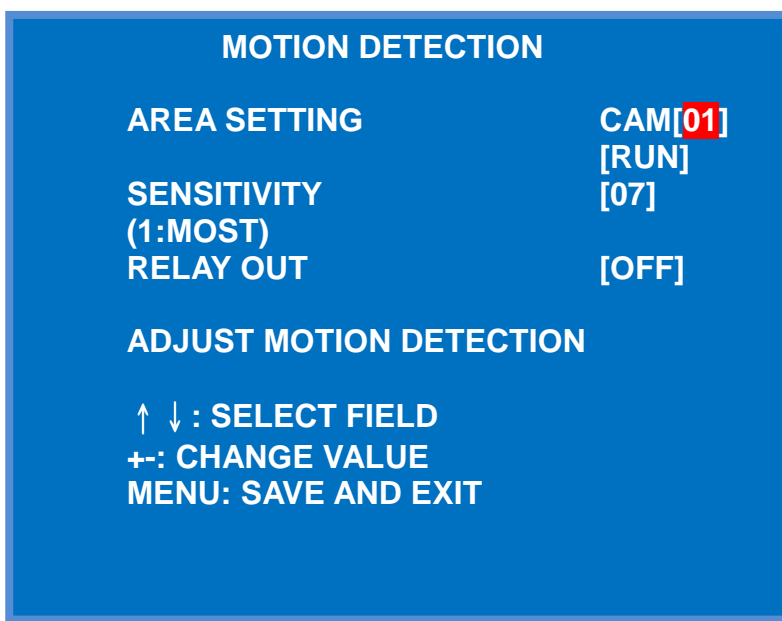

1. Highlight CAMERA AREA SETTING section and use “+” or “-” to choose each camera channel. Once channel is confirmed, highlight “**RUN**” and press “←” to start area setting.

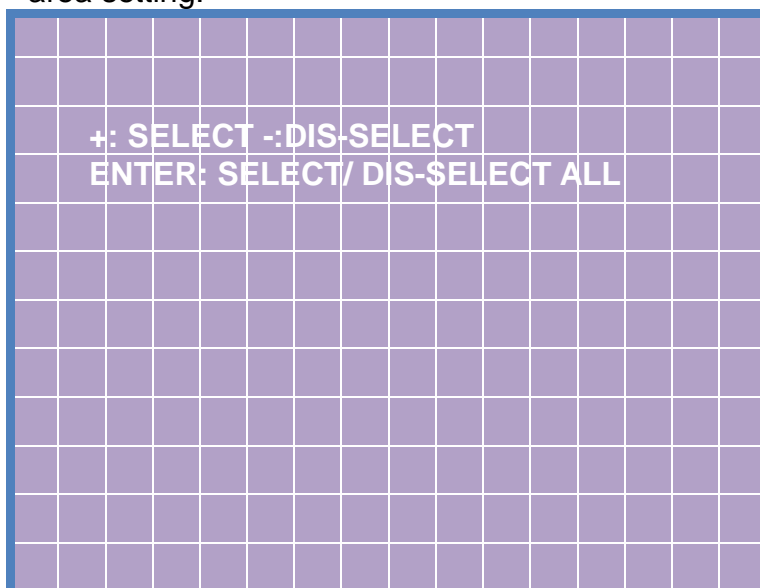

A 16 × 12 cell blocks pops out. Use “↑”, “↓”, “←”, and “→” key to select each cell and use “+” or “-” button to enable or disable motion detecting block. A highlighted cell block means the motion detection. Users may press “↵” button to select or deselect all cell blocks.

2. To adjust sensitivity, use “↑” or “↓” key to highlight SENSITIVITY section and press “+” or “-” key to cycle available sensitivity values, from 1 ~ to 7.  
(Note: Value 1 is the most sensitive)
3. To activate relay function, use “↑” or “↓” button to highlight RELAY OUT and press “+” or “-” button to turn it on or off.

**NOTE:**

When RELAY OUT is on, the relay in DVR will activate the external buzzer alarm device which is connected to ALARM OUT on the alarm switch terminal.

4. Press “” (Menu Button) to save all changes and go to the previous page.

### Status Select

In this section, users can choose the channels of video to be visible or invisible in live view mode.

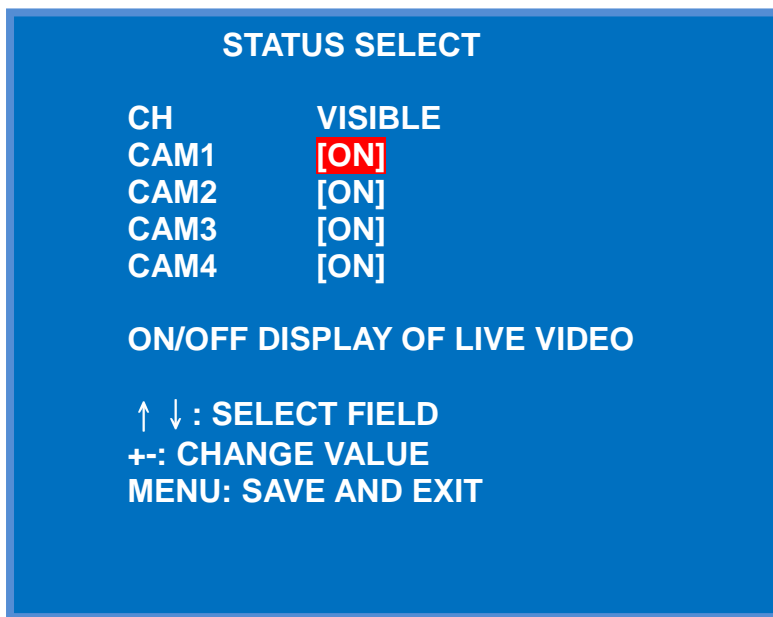

1. Press “↑” or “↓” key to highlight each channel of video.
2. Use “+” or “-” button to choose ON or OFF. ON means the channel is visible in Live View display; OFF means the channel is invisible in Live View display.
3. Press “” (Menu Button) to save all changes and go to the previous page.

**NOTE:**

DVR still records the video even if the channel is invisible.

### NTSC/PAL Setup

The default setting of video format is corresponding to the importing country. In case of using the DVR in different video format zones, users may need to adjust video format in this section.

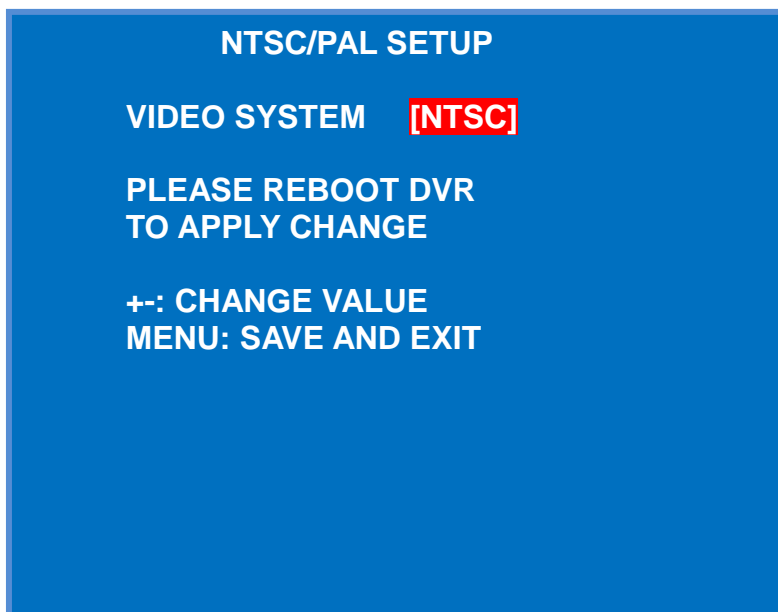

1. Press “+” or “-” key to choose NTSC system or PAL system.
2. Press “” (Menu Button) to save all changes and go to the previous page.
3. Reboot DVR to activate the new setting.

### ***Record Setup***

Under this section, users are allowed to setup record mode and schedule, record video quality and record rate. Use “↑” or “↓” key to choose each section and press “” to enter.

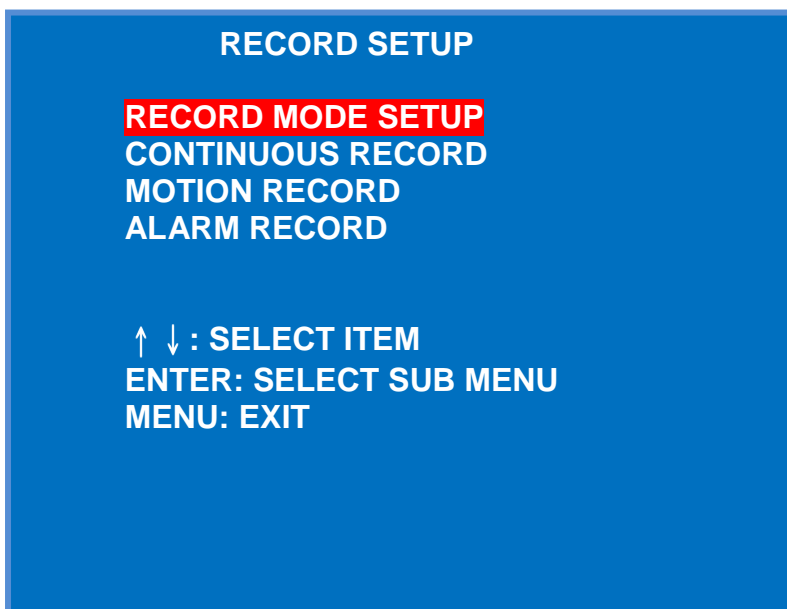

## Record Mode Setup

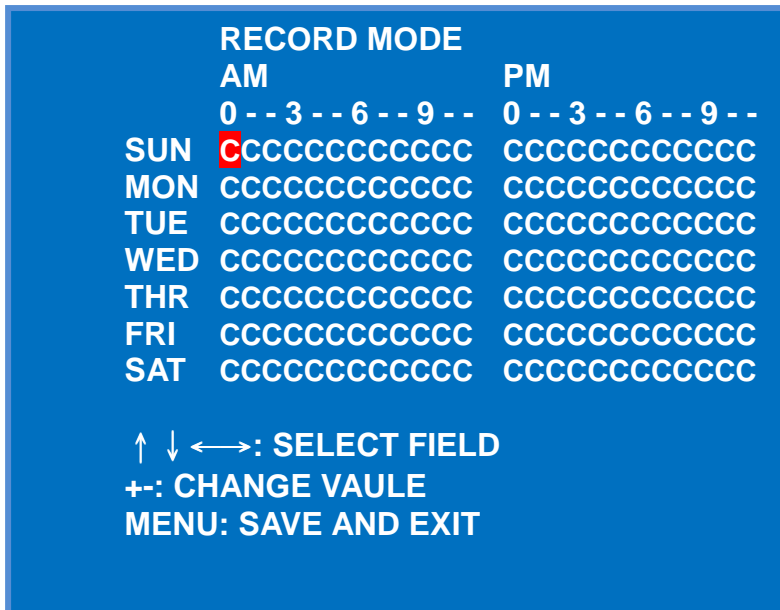

1. Use “↑”, “↓”, “→” or “←” key to select each time cell. Press “+” or “-” button to cycle through available record modes. Available record modes are: **C: Continuous, M: Motion Detection Recording, A: Alarm/Sensor trigger recording, N: None.**
2. Users may do fast set up by pressing “↵” twice. For example, move the cursor to Sunday row and choose any cell’s record mode to “M”. Press “↵” twice and the entire time cells of Sunday become “M” record mode.
3. Press “” (Menu Button) to save all changes and go to the previous page.

NOTE:  
 DVR stops recording when DVR is backing up or linking to PC through USB

## Continuous Record

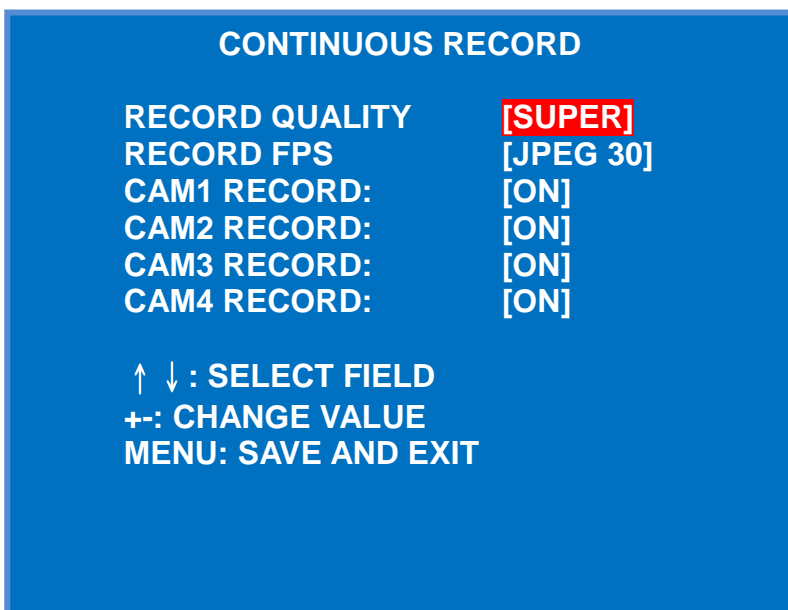

1. Press “+” or “-” button to cycle through available values. They are: **SUPER, HIGH,**

**NORMAL, STANDAR**, where **SUPER** is the highest video quality, and **STANDARD** is the lowest video quality.

2. Use “↑” or “↓” key to highlight “RECORD FPS” and press “+” or “-” button to cycle through available values. Users can choose compression format from MJPEG and MPEG4. The available values of FPS for MJPEG are: **1, 2, 4, 8, 15**, and **30**. **30** is for the most fluent recording and consumes HDD space the most. The available values of FPS for MPEG4 are **2, 4, 8, 15, 30**, and **60**.
3. Users can enable or disable continuous recording for each channel. Use “+” or “-” to select “ON” or “OFF”. “ON” means enable the channel recording, and “OFF” means disable the channel recording.
4. Press “” (Menu Button) to save all changes and go to the previous page.

## Recording Duration

### MJPEG Compression

Quality	Size per frame (KB)	FPS	Size per hour (MB)	Hours for an 160GB HDD
Super	21	1	74	2,167
		2	148	1,084
		4	295	542
		8	591	271
		15	1,107	144
		30	2,215	72
High	17.9	1	63	2,543
		2	126	1,271
		4	252	636
		8	503	318
		15	944	170
		30	1,888	85
Normal	15.23	1	54	2,988
		2	107	1,494
		4	214	747
		8	428	374
		15	803	199
		30	1,606	100
Standard	12.9	1	45	3,528
		2	91	1,764
		4	181	882
		8	363	441
		15	680	235
		30	1,361	118



### MPEG4 Compression (Dual Codec Mode Only)

Quality	Size per frame (KB)	FPS	Size per hour (MB)	Hours for an 160GB HDD
Super	7.0	2	49	3,251
		4	98	1,625
		8	197	813
		15	369	433
		30	738	217
		60	1,477	108
High	6.0	2	42	3,814
		4	84	1,907
		8	168	953
		15	315	509
		30	629	254
		60	1,259	127
Normal	5.1	2	36	4,482
		4	71	2,241
		8	143	1,121
		15	268	598
		30	535	299
		60	1,071	149
Standard	4.3	2	30	5,292
		4	60	2,646
		8	121	1,323
		15	227	706
		30	454	353
		60	907	176

## Motion Record

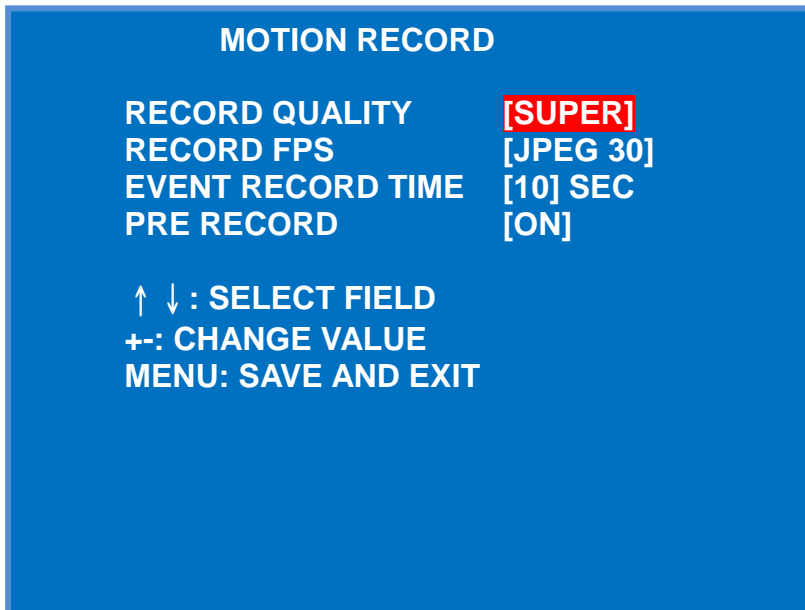

1. Press “+” or “-” button to cycle through available values. They are: **SUPER, HIGH, NORMAL, STANDAR. SUPER** is the highest video quality, and **STANDARD** is the lowest video quality.
2. Use “↑” or “↓” key to highlight “RECORD FPS” and press “+” or “-” button to cycle through available values. The available values of FPS for MJPEG are: **1, 2, 4, 8, 15,** and **30**. **30** is for the most fluent recording and consumes HDD space the most. The available values of FPS for MPEG4 are **2, 4, 8, 15, 30,** and **60**.
3. Use “↑” or “↓” key to highlight “RECORD TIME” and press “+” or “-” button to cycle through available times. They are: **10, 20, 30, 40, 50,** and **60** seconds. A record time of 10 seconds means DVR will record for 10 seconds after the motion is detected.
4. Use “↑” or “↓” key to highlight “PRE RECORD” and press “+” or “-” button to turn ON / OFF the Pre-Record. Pre-record records around 4 sec video before the motion is detected.
5. Press “” (Menu Button) to save all changes and go to the previous page.

## Alarm Record

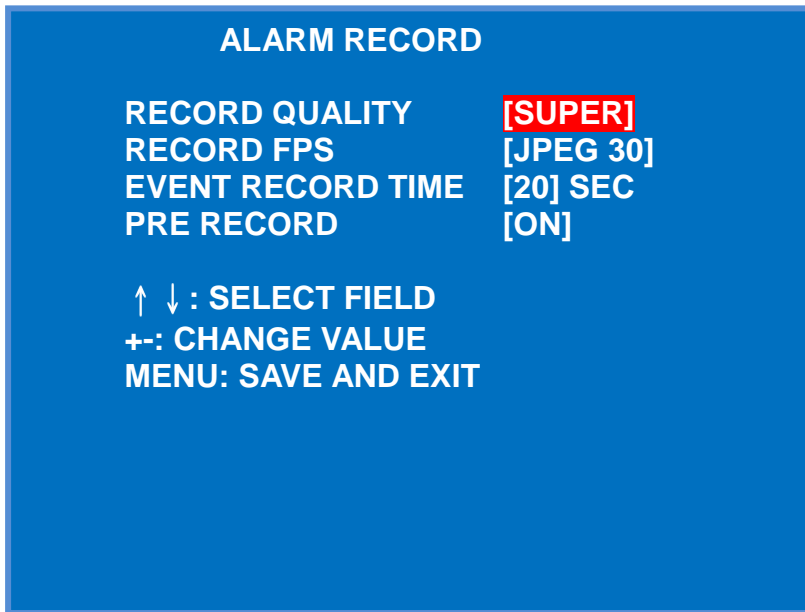

1. Press “+” or “-” button to cycle through available values. They are: **SUPER, HIGH, NORMAL, STANDAR. SUPER** is the highest video quality, and **STANDARD** is the lowest video quality.
2. Use “↑” or “↓” key to highlight “RECORD FPS” and press “+” or “-” button to cycle through available values. The available values of FPS for MJPEG are: **1, 2, 4, 8, 15,** and **30**. **30** is for the most fluent recording and consumes HDD space the most. The available values of FPS for MPEG4 are **2, 4, 8, 15, 30,** and **60**.
3. Use “↑” or “↓” key to highlight “RECORD TIME” and press “+” or “-” button to cycle through available times. They are: **10, 20, 30, 40, 50,** and **60** seconds. A record time of 10 seconds means DVR will record for 10 seconds after the alarm is triggered.
4. Use “↑” or “↓” key to highlight “PRE RECORD” and press “+” or “-” button to turn ON / OFF the Pre-Record. Pre-record records around 7 sec video before the alarm is triggered.
5. Press “” (Menu Button) to save all changes and go to the previous page.

**NOTE:**

For more details of alarm recording and ALARM MODE SETUP, please refer to “ALARM SETUP” on Page 42.

To install alarms or sensors, please see “ALARM / SENSOR INSTALLATION” on Page 16.

## Backup Setup

This DVR provides two backup methods. Users can back up video to PC via USB port or to USB memory storage devices. It also copy the player program to USB memory storage devices, so users can play the video on any PC (Apple system is not supported) without installing the player program.

### PC Backup Note:

1. PC operating system must be Windows 2000 or above.
2. Install PC player program (provided in the disc) to the PC first. Do not run the PC player program on the CD ROM.
3. Please use the USB port on the rear side of the PC as your platform.

**Flash Disk Backup Note:**

1. USB 2.0 is recommended.
2. USB memory storage device will be formatted in USB Master Backup. Please back up all the files before using USB Master Backup.
3. Upload PC player program first. Refer to Page 10 for instructions of uploading PC player to DVR.

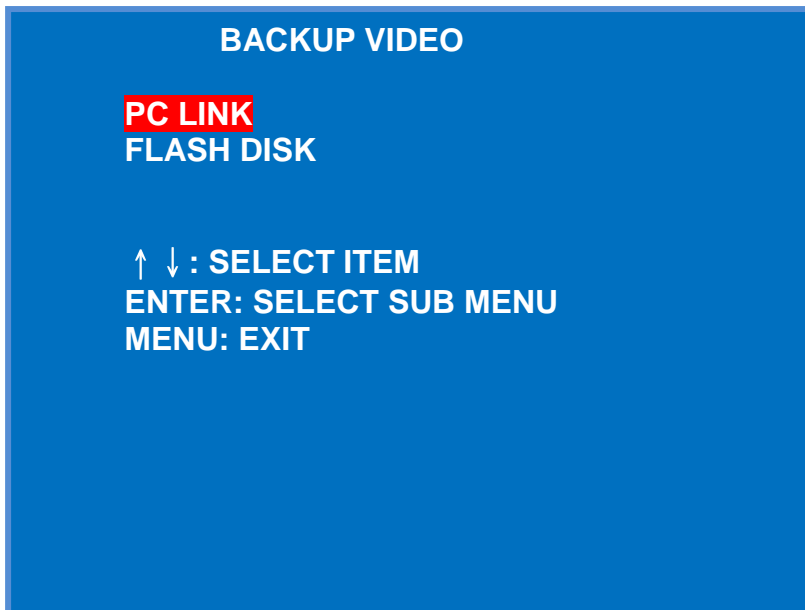

**PC LINK**

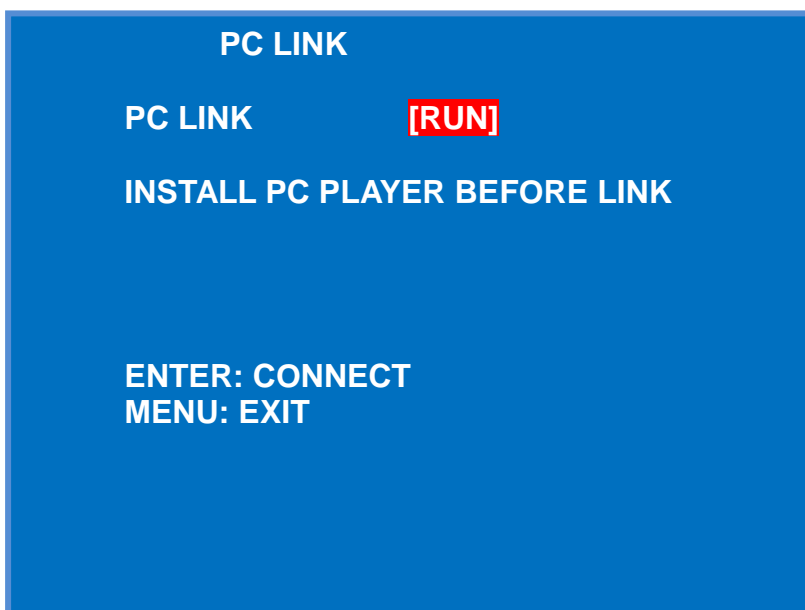

1. Connect DVR to PC via USB cable provided in the package.
2. Highlight "RUN" and press "←]" to make the connection between PC and DVR. If DVR

is successfully connected to PC, you will see a USB mass storage connection icon on the right and low side of PC screen. DVR screen also shows USB connection is ok.

There is a USB device icon show on your screen when PC detects DVR HDD.

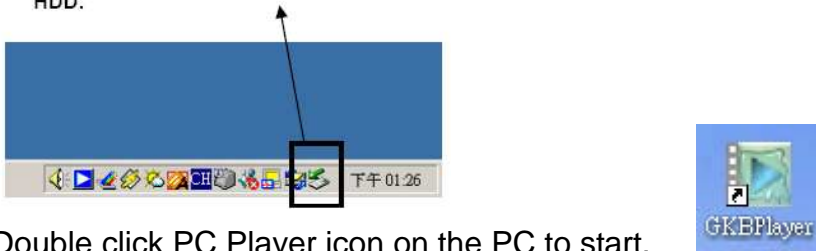

3. Double click PC Player icon on the PC to start.
4. Refer to **PC PLAYER Program** on Page 51 for PC player operation.
5. Press “■” to cancel the connection to the PC.
6. Press “☰” (Menu Button) to save all changes and go to the previous page.

## FLASH DISK

FLASH DISK		
HDD	YY/MM/DD	HH:MM
BEGIN	07-08-12	09:11
END	07-08-16	10:22
USB BACKUP		
BEGIN	07-08-12	09:11
END	07-08-16	10:22

1. Use “↑”, “↓”, “←”, or “→” key to highlight USB backup begin & end date and time. Press “+” or “-” key to cycle through available values.
2. After confirming the USB backup recording period, press “↵” to enter “USB MASTER WARNING” page.
3. “USB MASTER WARNING” page appears on the screen. Press “↵” to format USB Flash and begin backup. Press “☰” (Menu Button) to cancel and exit the warning page.

**Note:**

When the flash drive is full, users can change a new flash drive and press QC button to resume backing up. Otherwise, press “■” to stop.

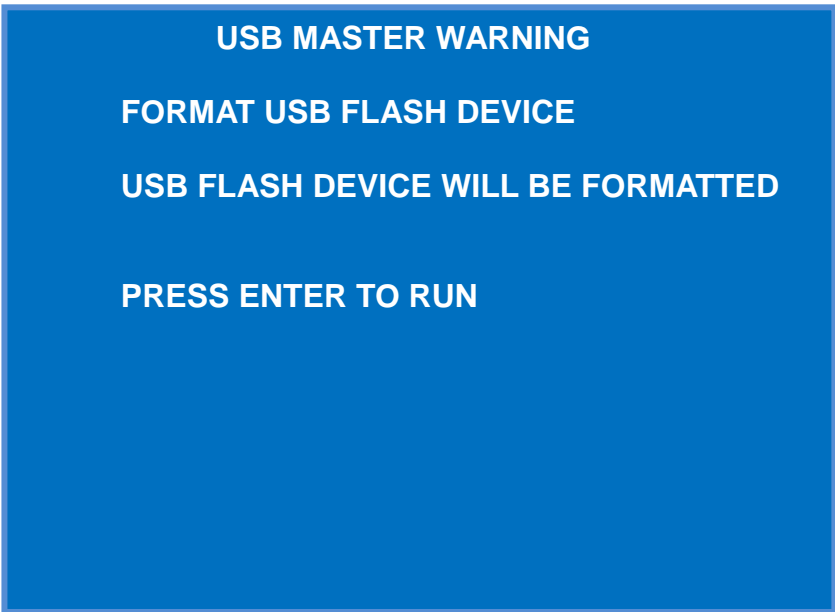

4. When the backup is completed, press “■” to exit backup progress. Press “” key to exist and return to live view.
5. Unplug the USB memory storage device and connect to any PCs (except Apple system) to view the video.
6. Refer to **PC PLAYER Program** on Page 51 for PC player operation.

NOTE:  
When selecting the backup time, make sure the beginning time of video is valid. If the beginning time of video is not valid, DVR will start from the nearest time point.

**TCP/IP SETUP (Only for DIGI-VIEW4PRON)**

System Requirement: Microsoft Windows 2000 or above Operating System, Pentium 4 or above CPU, 512 MB or above DRAM.

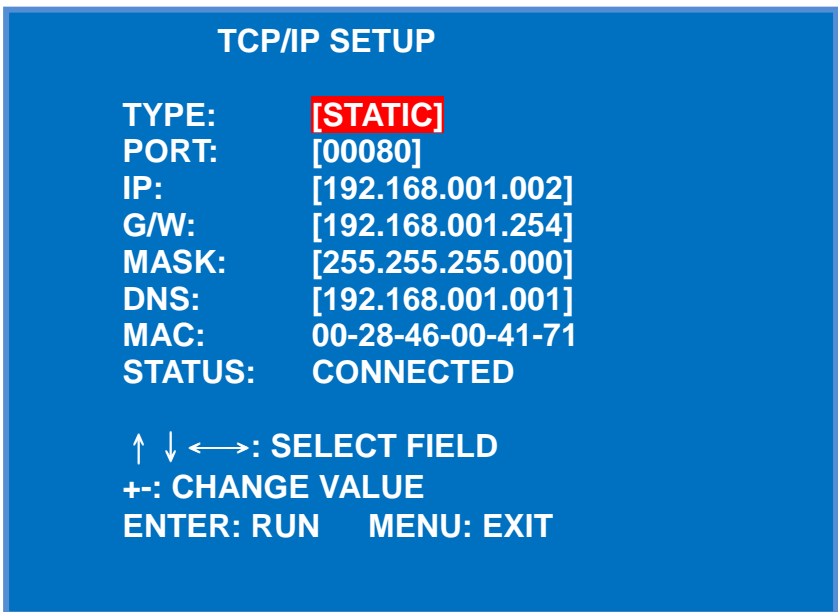

Network function lets users to view live video and recorded video via the Internet. It also supports DDNS function for users if they only have dynamic IP ADSL service from ISP. Users may do network configuration in this section. The default IP address of the DVR is 192.168.1.1; port number is 80; Subnet mask is 255.255.255.0, and Gateway is 192.168.1.254.

1. Use “↑” or “↓” to choose network type and its necessary items.
2. Press “+” or “-” to cycle through available values.
3. Highlight “APPLY” and press “←” to apply the new setting.
4. Press “☰” (Menu Button) to go to the previous page.

**NOTE:**  
Before setting up, please identify the network connection of the DVR

## STATIC IP

### Public Static IP Connection

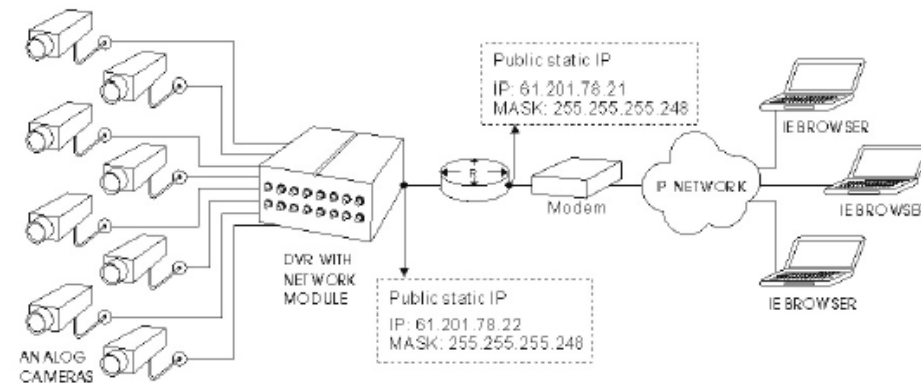

### Private / Virtual IP Static IP Connection

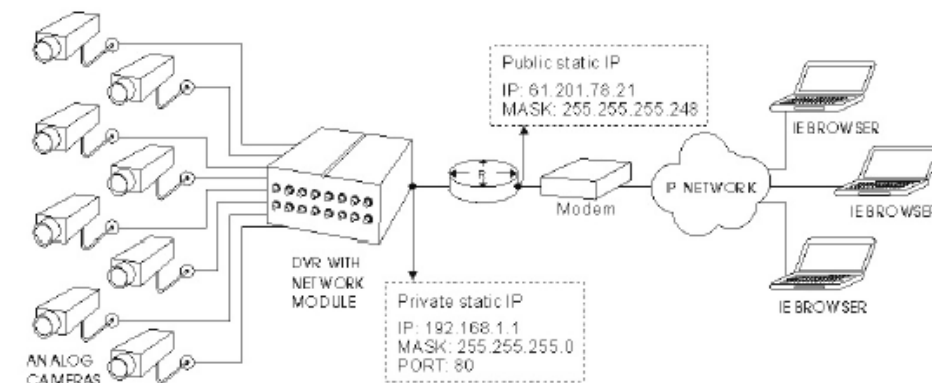

Static IP is considered as a fixed IP assigned by ISP (Public IP) or IP share device (Virtual IP). DVR connecting to static IP needs to be assigned IP address, Gateway, and Subnet mask.

## DHCP

The DHCP functions needs to be supported by a router or a cable modem network with DHCP services. Please apply DDNS when use DHCP connection. For DDNS service, please refer Page 83.

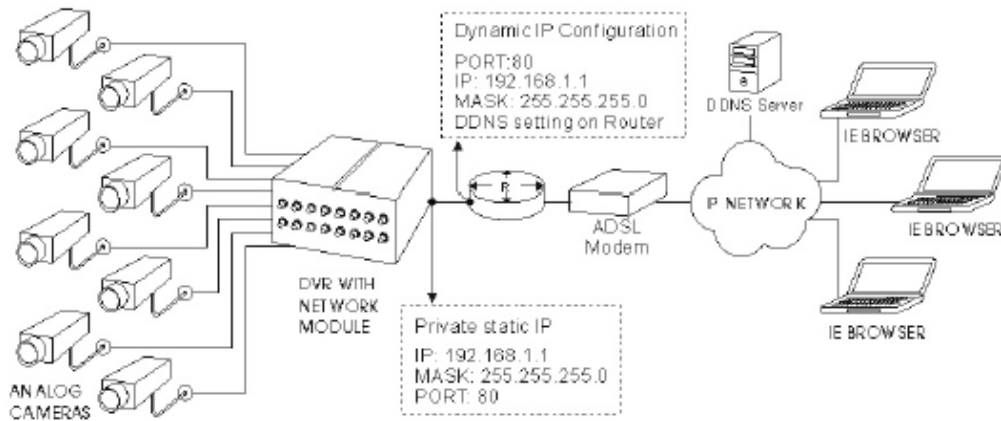

## PPPoE

This PPPoE function needs to have one “username” and one “password” subscribed from one ISP supplier. Please apply DDNS **first** when use PPPoE connection. For DDNS service, please refer to Page 83. After applying DDNS, please also set up username and password for PPPoE connection. (Refer to Page 61 for PPPoE password and username setup.)

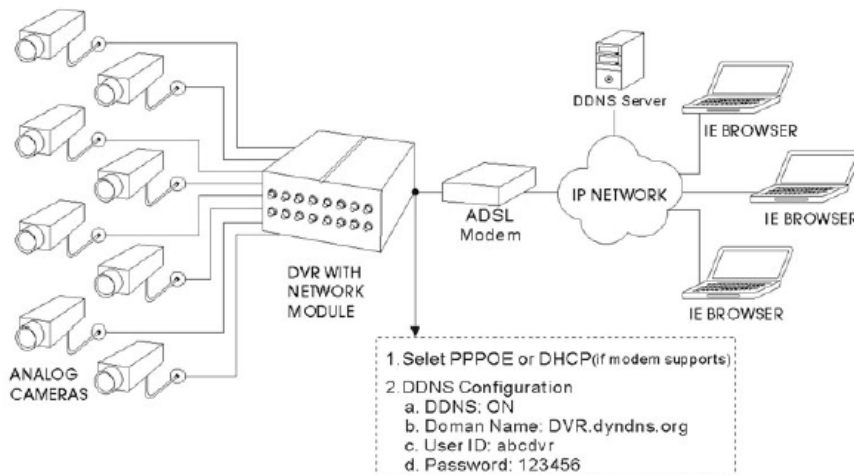



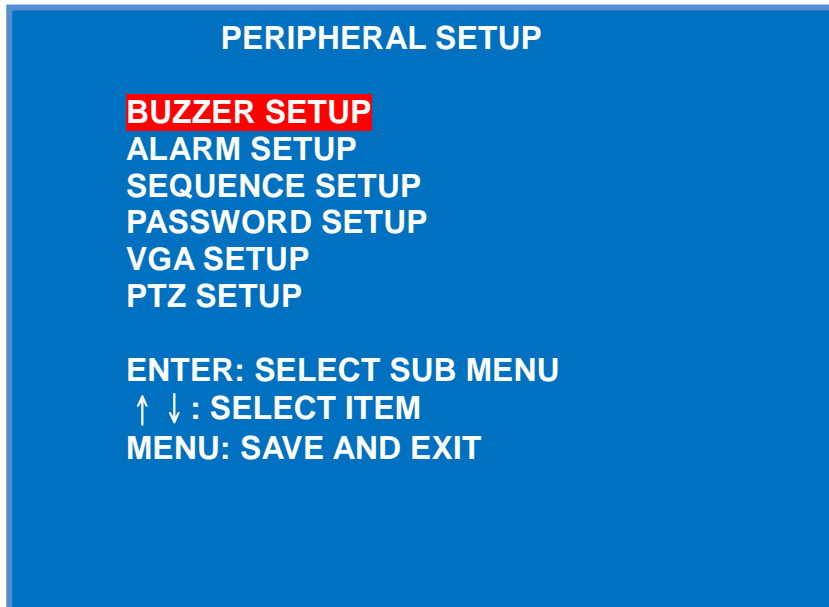

## Peripheral Setup

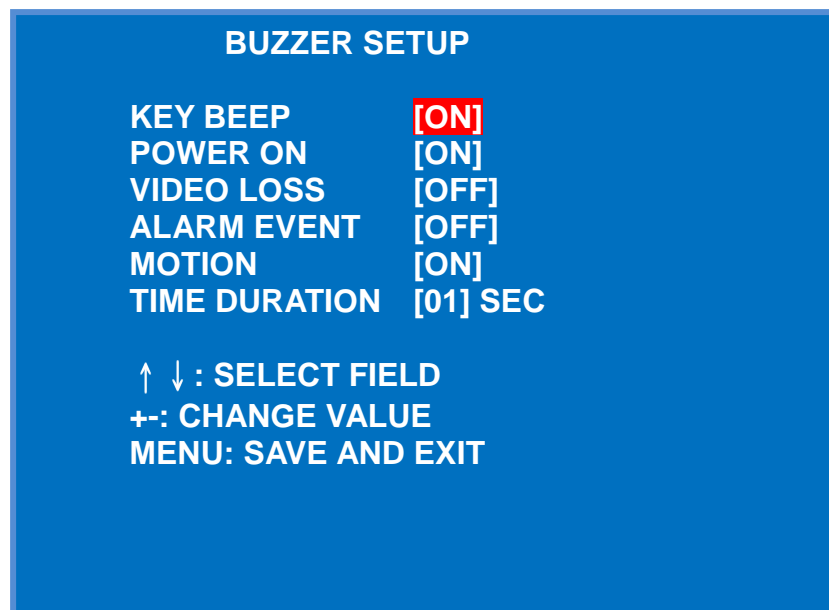

### Buzzer Setup

Use “↑” or “↓” to select each buzzer option and use “+” or “-” to change the value.



1. When “KEY BEEP” is on, DVR beeps every time when users press any buttons on the key pad.
2. When “POWER ON” is on, DVR beeps when it is turned on.
3. When “VIDEO LOSS” is on, DVR beeps when it detects video loss of any channels.
4. When “ALARM EVENT” is on, DVR beeps when external installed alarm/sensor trigger is activated.
5. When “MOTION” is on, DVR beeps when it detects motion detection.
6. Users can select the length of buzzer time after the events. Press “+” or “-” key to cycle through available values, from **1 ~ 60** seconds.
7. Press “” (Menu Button) to go to the previous page.

NOTE:  
TIME DURATION IS ONLY FOR "MOTION", "ALARM", AND "VIDEO LOSS"  
EVENTS.

## Alarm Setup

This DVR is capable of installing four external input alarm/sensor devices and one output external alarm device. Use "↑" or "↓" key to choose each setup section and press "↵" to enter it.

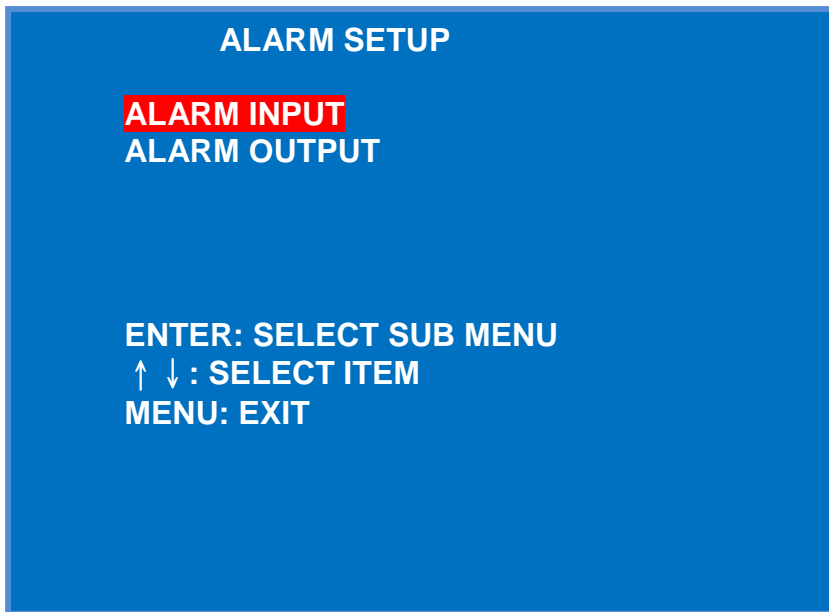

### Alarm Input Setup

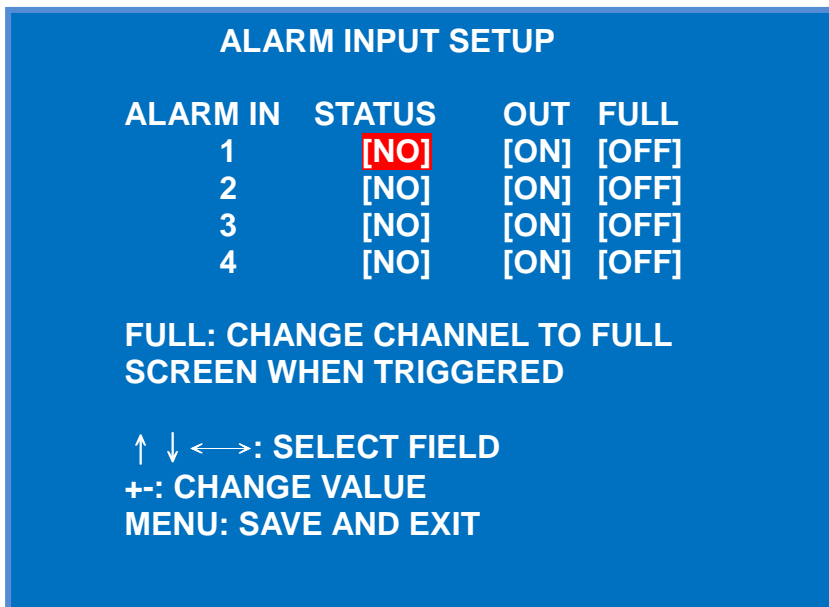

This DVR can accept **four** alarm/sensor inputs.

1. Press "↑", "↓", "→" or "←" to highlight each channel's alarm setup options.
2. Use "+" or "-" key to cycle through available options.

3. Press “” (Menu Button) to save all changes and go to the previous page.

### **STATUS**

**NO: Normal Open** means the external alarm/sensor device is short circuit under normal circumstances. When the circuit is **completed**, DVR starts to record.

**NC: Normal Close** means the external alarm/sensor device circuit is completed under normal circumstances. When the circuit is **short**, DVR starts to record.

### **OUT**

DVR supports one alarm out. **ON** means DVR activates the external alarm/sensor device such as buzzer alarm when the input alarm of that channel is triggered. For example, if you set Channel 2 ALARM OUT to “**ON**”, and the input alarm channel 2 is triggered, DVR activates the external buzzer alarm. (Refer to ALARM/SENSOR Installation on Page 16.)

### **FULL**

DVR displays certain channel of video in full screen if external alarm/sensor is triggered of that channel. For example, when Alarm In 1 is set to ON, Channel 1 will switch to full screen (Each Channel Mode) after the input alarm channel 1 is triggered.

### *Alarm Output Setup*

This section allows users to decide the length of alarm output time.

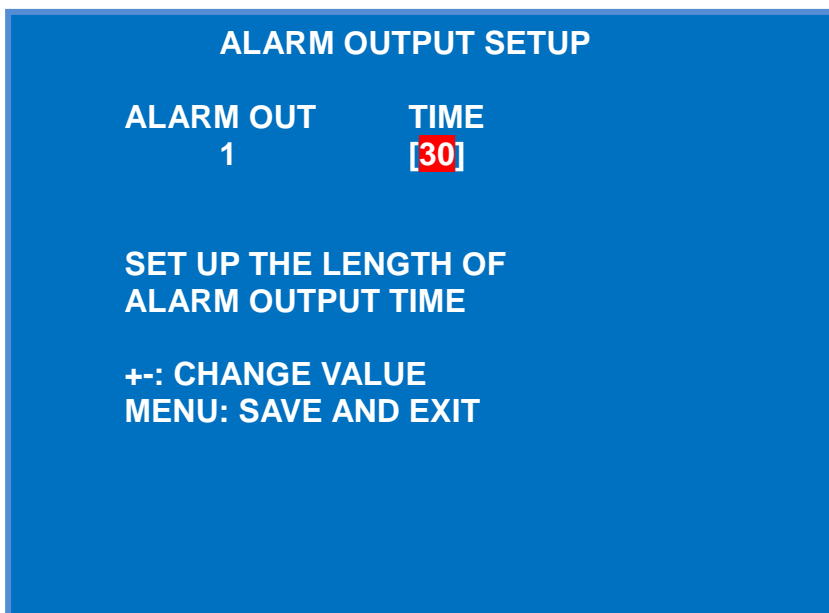

1. Cycle available values, **1 ~ 60 seconds**, with “+” or “-” key.
2. Press “” (Menu Button) to save all changes and go to the previous page.

### **Sequence Setup**

Users are able to adjust the interval of displaying each channel in Sequence Display Mode.

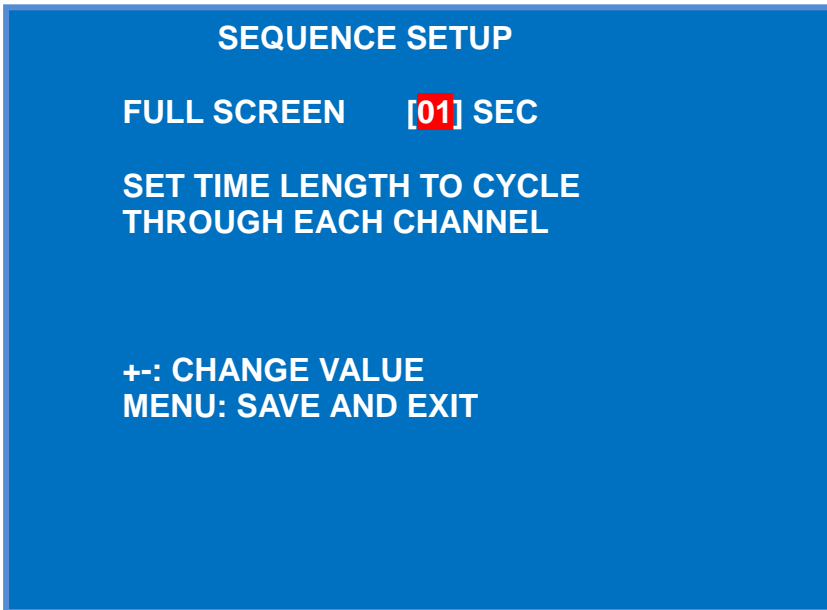

1. Cycle available values, 1 ~ 60 seconds, with “+” or “-” key.
2. Press“” (Menu Button) to save all changes and go to the previous page.

### Password Setup

This DVR allows users to input 4 numerical digits as the system password. DVR asks for password when users try to release KEY LOCK function and stop recording. The factory default password is **0000**.

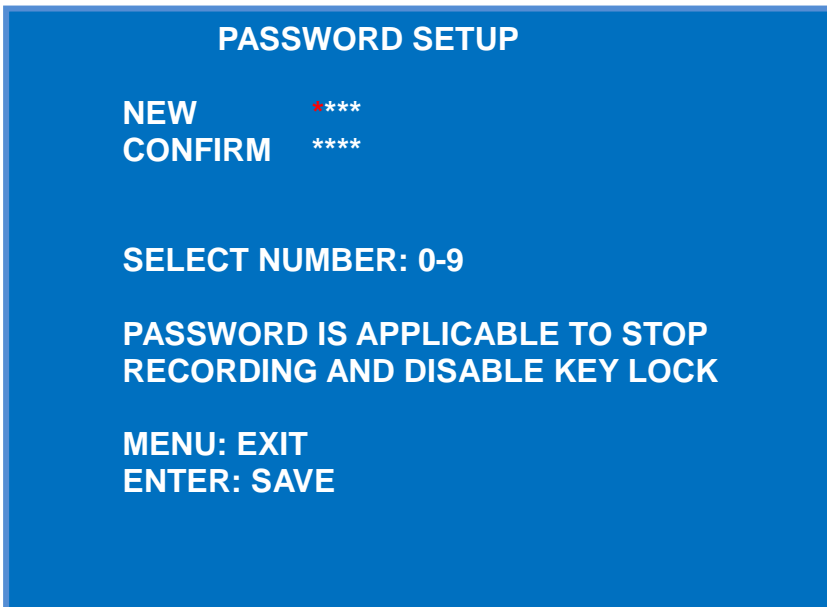

1. Press Key Pad to set the password. (Refer to the following table.)
2. Use “←” to move backward to correct.
3. Type in both NEW and CONFIRM fields.
4. Press “↵” to validate the new password.
5. Press“” (Menu Button) to validate the new password and go to the previous page.

## Key Pad Indication

■ -> 0	CH1 -> 1	CH2 -> 2	CH3 ->3	CH4 -> 4
QUAD -> 5	PIP -> 6	SEQ -> 7	-> 8	◀-> 9

### NOTE:

The universal password is: QUAD, SEQ, || (Pause), QUAD. (5785)

## VGA Setup

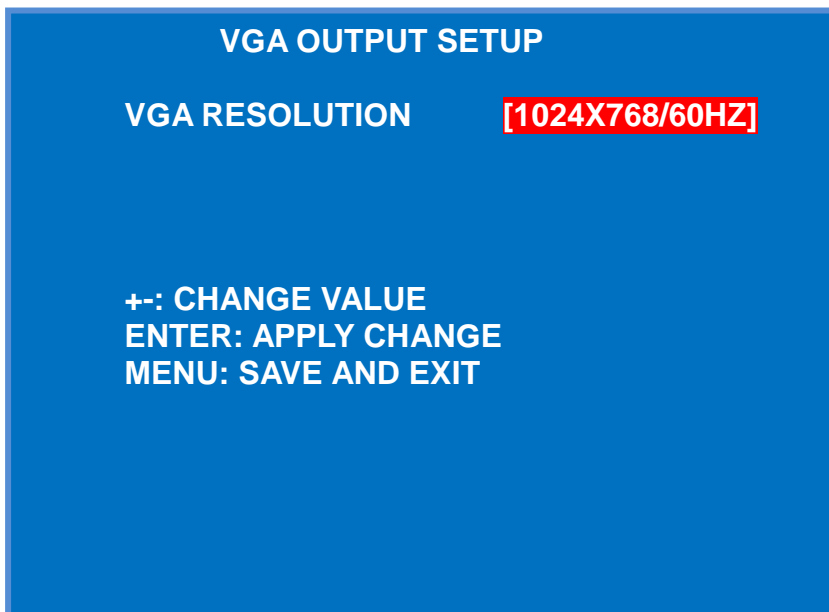

1. Use “+” or “-” key to cycle through available values: **640\*480/60Hz**, **640\*480/75Hz**, **800\*600/60Hz**, **800\*600/75Hz**, **1024\*768/60Hz**, and **1024\*768/75Hz**.
2. Press “↵” to apply change.
3. Press “☰” (Menu Button) to save all changes and go to the previous page.

## PTZ Setup

PTZ SETUP	
ID	[01]
PROTOCOL	[PELCO-D]
BAUD RATE	[2400]

↑ ↓ : SELECT FIELD  
+ -: CHANGE VALUE  
MENU: SAVE AND EXIT

PTZ supports PELCO-D and PELCO-P protocols. Baud Rate supports 2400, 4800, and 9600.

## Date Time Setup

Users can adjust date and time settings in this section.

DATE TIME SETUP	
FORMAT	[YY/MM/DD]
YEAR	[2007]
MONTH	[07]
DAY	[06]
HOUR	[17]
MINUTE	[16]
SECOND	[24]

↑ ↓ : SELECT FIELD  
+ -: CHANGE VALUE  
MENU: SAVE AND EXIT

1. Press “↑”, “↓”, “→” or “←” to select each field to modify.
2. Use “+” or “-” key to cycle through available options.
3. After adjustment, press “” (Menu Button) to save all changes and go to the previous page

Format is the date format that shows on the live view. Available values are YY/MM/DD, MM/DD/YY, and DD/MM/YY.

## Hard Disk Setup

Users are allowed to view HDD information, format HDD, and choose HDD recording mode. Use “↑” or “↓” key to choose each section and press “↵” to enter.



## Hard Disk Information

It shows HDD model number and size.

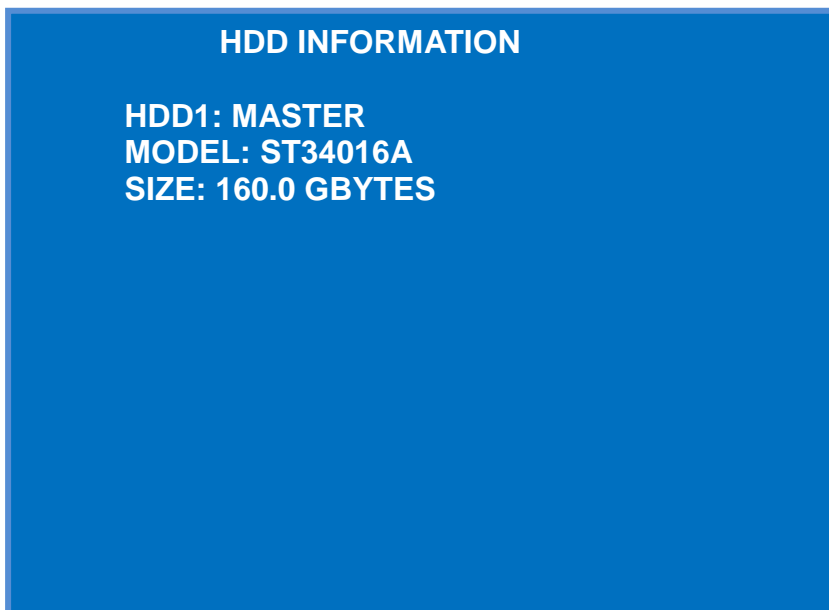

Press “” (Menu Button) to go to the previous page

## HDD Format

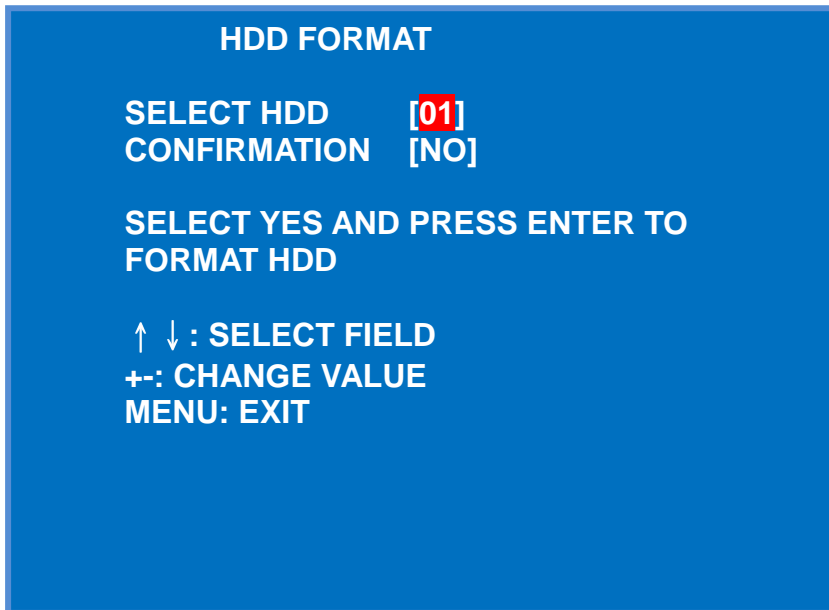

1. Change NO to YES and press “↵” key to format the HDD.
2. On the screen, it shows the percentage of the progress.
3. After formatting HDD, DVR goes back to the live view.

## HDD Record Mode

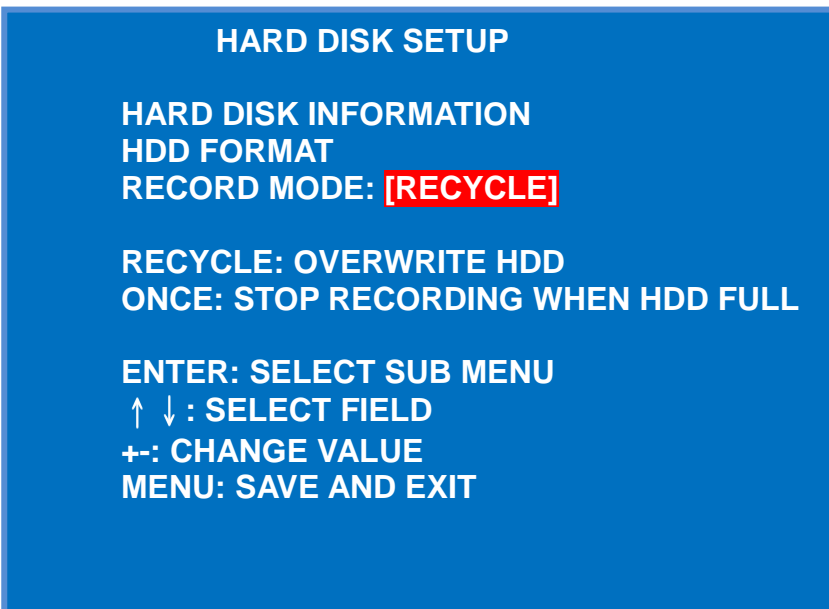

1. Press “+” or “-” button to cycle through available modes. Available modes are **RECYCLE** and **ONCE**.
2. Press “” (Menu Button) to save change and go to the previous page.

**RECYCLE** → DVR overwrites the HDD when HDD is full.

**ONCE** → DVR stops recording when HDD is full.



## Factory Setup

Users are able to set DVR to factory default setting, format USB, upload PC player to DVR HDD, and upgrade the firmware of DVR in this section.

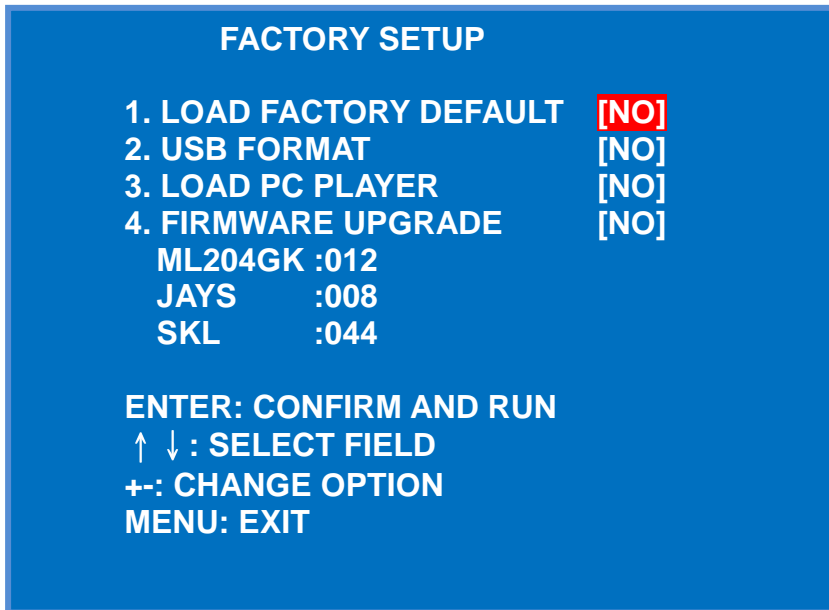

1. **Load Factory Default** allows to restore DVR to its factory default setting. Press “+” or “-” to choose **YES**. Press “↵” to run the loading.
2. **USB Format** allows users to format USB before uploading player to HDD and upgrades firmware to DVR.
  - a. Connect Memory Storage device to DVR USB Master Host plug.
  - b. Press “+” or “-” to choose **YES**.
  - c. Press “↵” to run the formatting.
3. **Load PC Player** allows users to backup video files to USB memory storage device and writing PC player program to it at the same time.
  - a. Format USB (**Note: Users must format USB first.**)
  - b. Remove USB from DVR Master Host plug and connect to PC USB plug.
  - c. Insert the CD provided in the package.
  - d. Open Both USB storage and CD ROM discs.
  - e. Replace player program, called “PLAYER.PAK” in the USB with “PLAYER.PAK” in the CD ROM disc.
  - f. Remove USB memory stick from PC properly and connect to DVR USB Master Host plug.
  - g. Use “↑” or “↓” to highlight “Load PC Player” section and press “+” or “-” to choose **YES**.
  - h. Press “↵” to run the loading.
  - i. After the loading is completed, press “■” to exit.
4. **Firmware Upgrade:** When there is available firmware released, users can update DVR firmware via USB. Please contact your local distributor for the updated firmware. (**Note: To avoid further confusions, we name the firmware “ROMCODE.ISO”.**)

Save the firmware temporarily in the PC and follow below steps:

- a. Format USB (**Note: Users must format USB first.**)
- b. Remove USB from DVR Master Host plug and connect to PC USB plug.
- c. Open Both USB storage device.
- d. Locate the updated firmware saved on the PC, usually called "ROMCODE.ISO"
- e. Replace firmware file, called "ROMCODE.ISO" in the USB drive with "ROMCODE.ISO" saved on the PC. (Or delete ROMCODE.ISO in the USB drive, and paste the updated firmware file to the USB drive.)
- f. Remove USB memory stick from PC properly and connect to DVR USB Master Host plug.
- g. Use "↑" or "↓" to highlight "Firmware Upgrade" section and press "+" or "-" to choose **YES**.
- h. Press "↵" to run the upgrading.
- i. After the loading is completed, press "■" to exit.

## PC Player Program



DVR Player supports DVR series from 4CH to 16CH. It plays videos recorded on the DVR, takes screenshots, and prints screen through a printer.

### ***Install PC Player Program***

1. Insert the CD provided in the package to the CD-ROM.
2. Click DVR PC Player on the menu to install.  
(Recommended Screen Resolution: 1024x786)
3. Select your destination directory and click OK.

### ***Connect DVR to Computer***

1. Use the USB cable provided in the package to connect DVR and the computer.
2. Plug one end of the USB cable to the PC port on DVR and the other end to the USB port on PC.

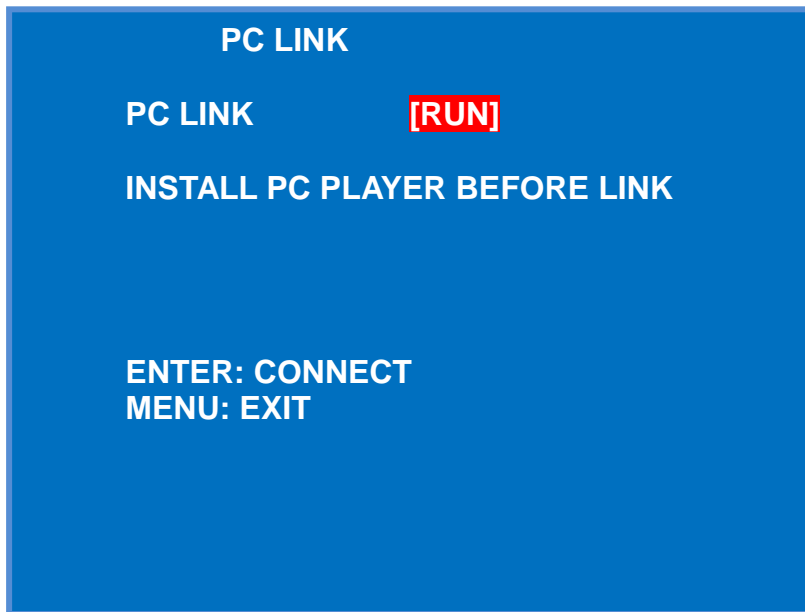



3. On DVR, select Backup Video → USB Slave. Press “↵” key to establish connection.
4. When connection is established, a new hardware icon  is shown in the notification area on the screen (lower right corner).

### ***Run PC Player Program***

1. After installation, there is a GKPlayer icon on the desktop. Double click it to run.
2. The main screen of PC Player is shown.

### ***Interface and Operation Indication***

#### **Open Video**

1. Click  to open “Open File List” dialog box.
2. Press  and select the DVR disk. Select any \*.dvr file and click Open. All the records are shown on the list.

Search all time (Start/End)	Search file event	Search all HDD event	
Copy file to PC	Copy event to PC		
File Name	Start Time	End Time	Type
F:\DVR_0005.DVR	2007/10/30 14:45:59	2007/12/18 16:25:15	PAL
F:\DVR_0005.DVR	2007/12/19 10:41:51	2007/12/19 11:19:10	NTSC
F:\DVR_0006.DVR	2007/12/18 16:25:15	2007/12/19 10:41:09	NTSC
F:\DVR_0007.DVR	2007/12/19 10:41:09	2007/12/19 10:41:51	NTSC

3. Select one of the record and press Open to view the video.
4. Users can directly copy the records to PC without opening them. Press

**Copy file to PC** and a “Copy file to PC” dialog box is shown. Select the destination path by pressing **Browse**. Type the file name and draw the time bar to set Start Time and End Time. Finally, press **Copy file to PC** to finish copying.

The screenshot shows a dialog box titled "Copy file to PC" with the following fields and buttons:

- 1. Select path : C:\Program Files\DVRPlayer\Backup (with a **Browse** button)
- 2. File Name : 20071218\_162515.DVR
- 3. Start Time : 2007/12/18 17:11:56 (with a **Set time** button)
- 4. End Time : 2007/12/19 10:19:22 (with a **Set time** button)
- 5. Start copy : (with a **Copy file to PC** button)
- A **Close** button is located at the bottom right.

5. Users can also copy event videos to PC without opening them. Press **Search file event** or **Search all HDD event**, and the events will be shown on the list. Click any one of the events and press **Copy event to PC**.



Select the destination path, file name, pre-record, post-record time, and press  to copy the event file to PC.

### Play Video

After opening the video, the video information is shown on the lower left corner. It shows the format, Start Time, and End Time of the video.













On the lower right corner, there shows playing statuses, including playing speed, date, and







time.

Operation Buttons:

	Start to play		Stop
	Reverse playback		Pause / Play frame by frame
	Rewind at 2x, 4x, or 8x		Forward at 2x, 4x, or 8x
	Reverse playback at 1/2x		Playback at 1/2x
	Go to the beginning		Go to the end
			
Time Bar: Quick search to certain time point			



## Channel / Display Buttons:

	Select certain channel for viewing
	Quad View
	Nine Channel View
	Sixteen Channel View

## Audio and Volume

If users use audio in with the DVR, they can adjust the audio channel and volume.



1. Click the buttons of Audio Select to select audio channels.
2. Draw the volume bar to adjust the volume.  Users can mute the audio by pressing the mute button .

## Save to JPG

Users can save the video screen to a JPG file.



1. Click , and it shows a "Save as" dialog box.
2. Select destination path and type the file name.
3. Press Save button to save the picture.

## Save to AVI

Users can save any certain period of the video to an AVI file.



Click , and there shows a Time Selecting Dialog.



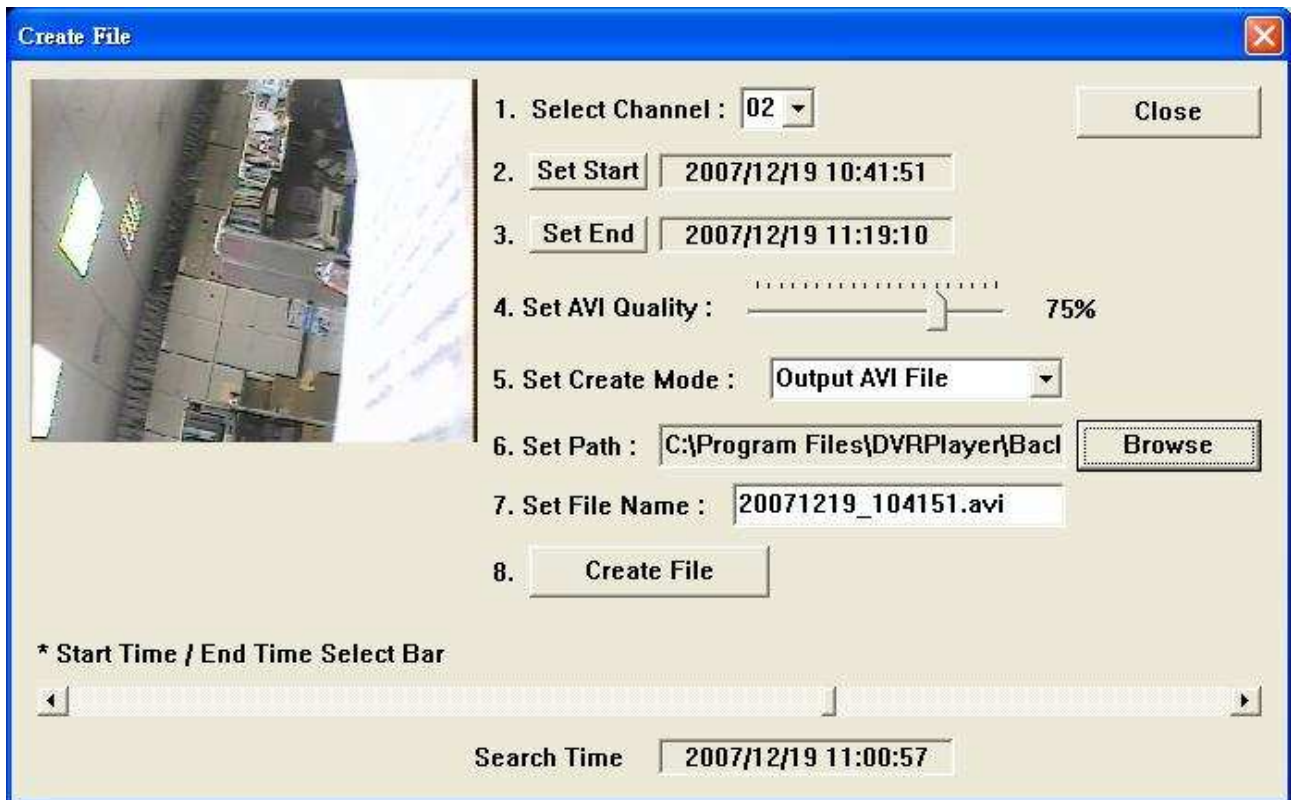

1. Select the channel to record.
2. Draw the time line bar to the time point you want to begin, and press **Set Start** to set Start Time.
3. Draw the time line bar to the time point you want to end, and press **Set End** to set End Time.
4. Choose the image quality you like by drawing the slider.
5. Select output mode: an AVI file, or JPEG files by 6 pictures per second.
6. Click **Browse**, choose the destination directory.
7. Type the file name for output.
8. Press **Create File** to proceed.

### Turn On/Off Time and Channel Indications

Press  to turn on or off the Time and Channel Indications on the screen.

### Print Screen

Users can print the screen through a printer by pressing .



## Internet Operation (Using IE Browser)

After setting the network function for DVR (please refer to [TCP/IP SETUP at Page 38](#)), users can manage / monitor through the IE browser.

Because the application developed for IE is using ActiveX, please install the ActiveX file in the CD. Click Active-X Plug-in Package to install.

To manage / monitor through the IE browser, please follow the steps:

1. Open IE.
2. Type DVR's IP address in URL. (If DHCP is used, please refer to [CMS at Page 68 to find DVR's IP.](#))
3. An authorizing window pops up. Type username and password (Default: **root/root**).



Note:  
If the DVR is in MENU pages, the changes of settings on IE browser will **NOT** be applicable to the DVR.

4. A multi management page is shown. Click Link button on the first cell.

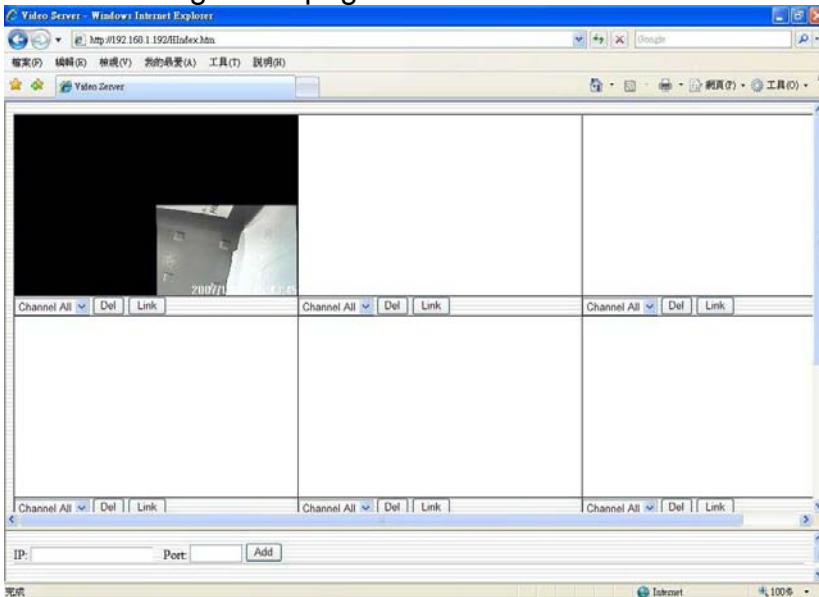

5. DVR's web management interface shows up as below picture.

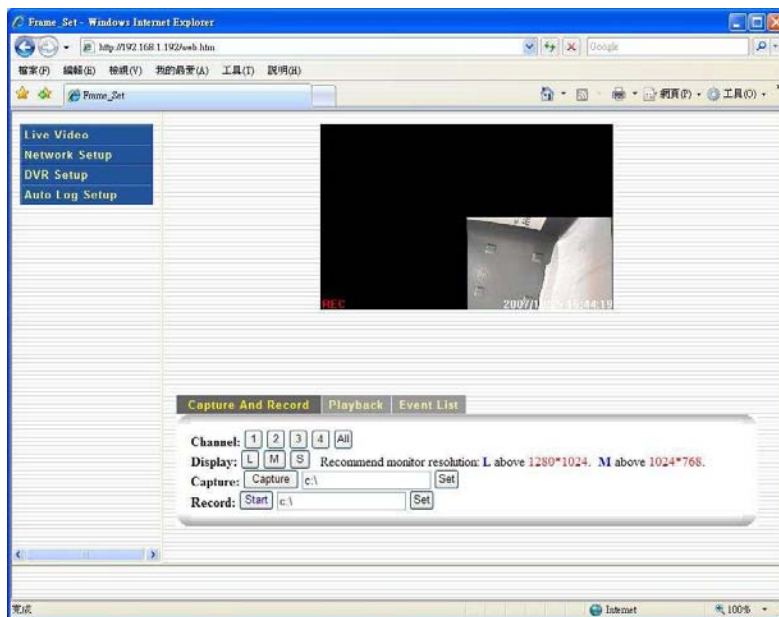

## Live Video

In Live Video page, users can see the live view, snap image, record video, and view playback.

## Capture and Record

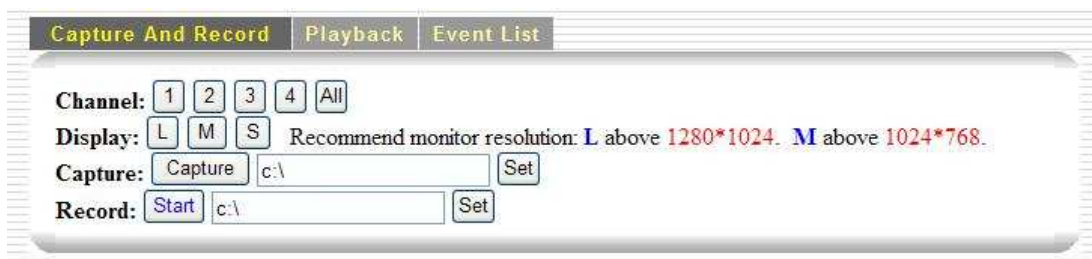

As soon as entering Live Video page, it displays the live view on DVR.

Channel: Users can change to see different channel or Quad mode by click the buttons

Display: Users can change the solution of the live view. L is the largest, where S is the smallest.

Capture: Users can snap images from the live view to the computer. Type the destination path and click Set to apply. And click Capture to save images to the path.

Record: Like Capture, Record saves the live view as video files to the computer. Type the destination path and click Set to apply. And click Record to save videos to the path.

## Playback

In Playback, users are able to review videos saved in HDD of DVR.

Capture And Record Playback Event List

**Channel:**

**Display:**    Recommend monitor resolution: **L** above 1280\*1024. **M** above 1024\*768.

**Search Time:** Year:  Month:  Day:  Hour:  Minute:

**Start Time:**

**End Time:**

Channel: Users can change to see different channel or Quad mode by click the buttons

Display: Users can change the solution of the live view. L is the largest, where S is the smallest.

Search Time: Users can review video at a specific point. Click Run to review.

Star Time: It indicates the very beginning of the recording. Click Run to review it.

End Time: It indicates the end of the recording. Click Run to review it.

Control Buttons: In the bottom row, there are control buttons to operate fast rewind, rewind, pause, forward, fast forward, and stop. **Click STOP to exit playback mode.**

**NOTE:**  
When starting Playback, DVR will stop recording and enter playback mode synchronously.

### Event List

The table here lists event recordings on DVR. Users can examine the event happening previously. Press the button on each event to start the playback.

Capture And Record Playback Event List

Page:

No.	Type	Channel	Year	Month	Day	Hour	Minute	Second	Playback
1	M	2	2008	02	15	14	26	16	<input type="button" value="1"/>
2	M	2	2008	02	15	14	26	15	<input type="button" value="2"/>
3	M	2	2008	02	15	14	25	38	<input type="button" value="3"/>
4	M	2	2008	02	15	14	25	38	<input type="button" value="4"/>
5	M	4	2008	02	15	14	24	57	<input type="button" value="5"/>

## Network Setup

### Server

In this section, users can manage network accounts, upgrade DVR firmware, and set up email notification.

### Account

Administrator:			User:		
Account	Password	Set	Account	Password	Set
root	root	1	user	user	1
networkadmin	networkadmin	2			2
		3			3
		4			4
		5			5

Users can setup maximum five administrator accounts and five user accounts.

Administrators can see the live view, record video to local computers, and change DVR settings.

Users can only see the live view from the multi management page.

### System

1. Device Name:

2. Load Network Default Setting:

3. Current Firmware Version:

(1) New Firmware Upgrade:

(2) Upload New Firmware:

(3) Re-boot Network Server:

In System page, users can do the following operations:

1. Change DVR's name.
2. Return Network Setting to Factory Default.
3. Upgrade Network Module Firmware.
  - a. Select firmware from the local computer.
  - b. Click UPLOAD to upload firmware and upgrade. (Then, click YES on popup window)
  - c. Click REBOOT to reboot DVR to complete upgrading procedure.

### E-Mail

Users can enable the email notification function by fill the table shown below.

1. SMTP Enable:  ON  OFF

2. E-mail address:

3. SMTP:

4. PORT:  (default port is 25)

5. SMTP Authenticate:  ON  OFF

(1) E-mail ID :

(2) E-mail Password:

6. TLS:  ON  OFF

**E-mail message type:**

1. Network Information: (1) IP change, (2) Type change  
 2. HDD Fail  
 3. Video Loss  
 4. Video Recover  
 5. Motion Detection

DVR will send notification emails when the following situations happen:

1. DVR's IP or network type is changed.
2. HDD fails.
3. Video loss occurs.
4. Video recovery occurs.
5. Motion detection occurs.

## Network

In network section, users can change network settings and DDNS setup. This section corresponds with TCP/IP SETUP in DVR. (Please refer to TCP/IP SETUP at Page 38)

### Type

DVR supports Static IP, DHCP (Dynamic IP), and PPPoE protocols.

TYPE: STATIC IP ▼

TYPE: STATIC IP

TYPE: DHCP CLIENT

TYPE: PPPoE

If your network environment uses Static IP, please select STATIC IP.

TYPE: **STATIC IP** ▼

IP Address	192	168	1	192
Subnet Mask	255	255	255	0
Gateway	192	168	1	1
DNS 1 IP	139	175	252	16
DNS 2 IP	0	0	0	0
Port	80			

In DHCP network environment, please select DHCP CLIENT. Choose ON and click Set to enable setting.

TYPE: **DHCP CLIENT** ▼

DHCP State:  OFF  ON  OFF

IP Address	192.168.1.192
Subnet Mask	255.255.255.0
Gateway	192.168.1.1
DNS IP	139.175.252.16

If PPPoE is used, please select PPPoE. Choose ON and fill in user ID and password subscribed from your ISP. Then, click Set to enable setting.

TYPE: **PPPoE** ▼

PPPoE State:  OFF  ON  OFF

PPPoE User ID:

PPPoE User Password:

IP Address	192.168.1.192
Subnet Mask	255.255.255.0
Gateway	192.168.1.1
DNS 1 IP	139.175.252.16
DNS 2 IP	

### DDNS

If a dynamic IP or PPPoE service is used and users want to use DDNS to get access to DVR, please choose ON and fill Name, ID, and Password. Click Set to enable DDNS for

DVR.

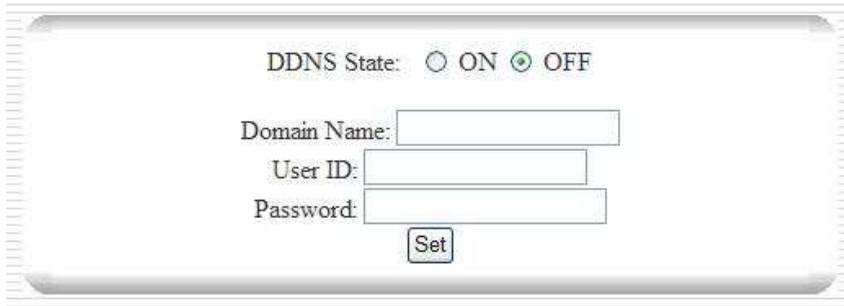

DDNS State:  ON  OFF

Domain Name:

User ID:

Password:

To apply for DDNS service, please refer to Page 83.

## DVR Setup

### System

Here the settings of Time, Camera, HDD, etc. can be modified in this page.

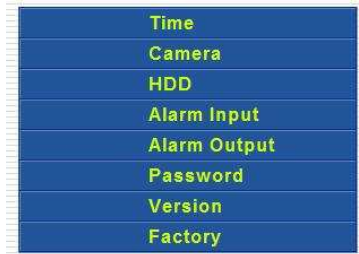

- Time
- Camera
- HDD
- Alarm Input
- Alarm Output
- Password
- Version
- Factory

### Time

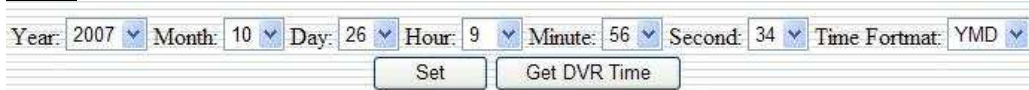

Year: 2007 Month: 10 Day: 26 Hour: 9 Minute: 56 Second: 34 Time Format: YMD

Choose each field to current time and click Set to apply change. Get DVR Time is used to retrieve DVR's time setting.

### Camera

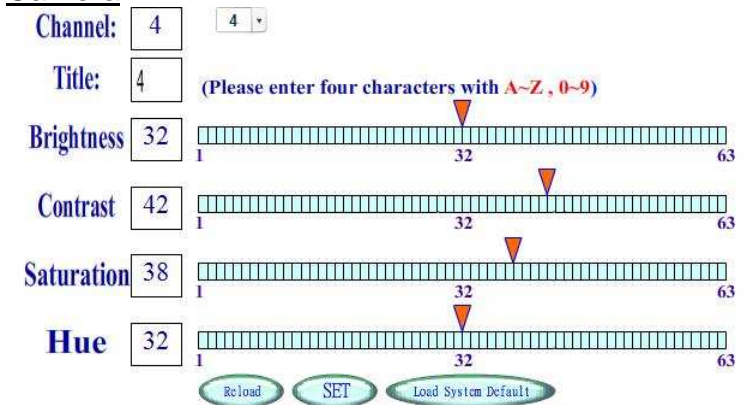

Channel:

Title:  (Please enter four characters with A~Z, 0~9)

Brightness:

Contrast:

Saturation:

Hue:

Each Camera/channel's setting can be changed here, including Title, Brightness, Contrast, Saturation, and Hue.

The button at the top part is used to select channel. Users can drag the red triangles to change values for each attribute.



Reload button is clicked to load the setting before dragging from DVR. Press SET to apply changes, and Load System Default is clicked to return to factory default setting.

### HDD

**HDD Information:**

HDD ID	Model	Size	Free Size
1	ST330620A	30.0	10.0

Record Mode:  Once  Recycle

Here shows the information on HDD in DVR. Users can change Record Mode to Once or Recycle. Click Set to apply change, and press Get Current Settings to retrieve current value for it from DVR.

### Alarm Input

Alarm\_Input\_ID: 1 Status: N.O Output: ON Full: OFF

If users have alarms inputs set up, the settings can be modified in this section. Click Set to apply changes, and press Get Current Settings to retrieve current values from DVR.

### Alarm Output

Alarm\_Output\_ID: 1 Enable: OFF Time: 30

When alarm output is used, the settings can be modified here. Click Set to apply changes, and press Get Current Settings to retrieve current values from DVR.

### Password

New Password:  Confirm New Password:

Users can change DVR's password in this section. Please note ONLY numerals can be used for password. And four digits must be keyed in at one time.

### Version

**DVR Firmware Version:**

ML : 017

JAYS: 013

SKL : 051



Version shows the current firmware version of DVR.

### Factory

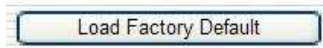

Load Factory Default button is clicked to return DVR to original factory default settings.

### **Record**

Record settings, such as Mode, Continuous, Alarm, and Motion, can be changed here.



### Mode

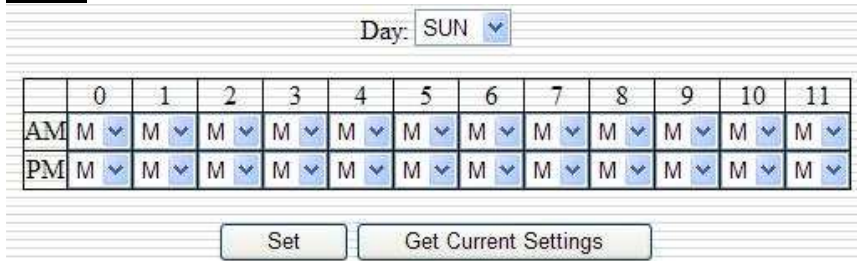

This is the recording schedule. Users can set every hour in each of seven days. C is for Continuous, M is for Motion Detection, A is for Alarm, and N is for None Recording.

Click Set to apply changes, and press Get Current Settings to retrieve current DVR settings.

### Continuous

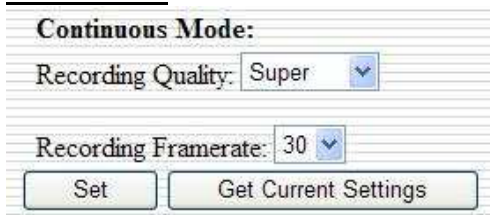

Users can adjust recording video quality and frame rate in this page.

Click Set to apply changes, and press Get Current Settings to retrieve current DVR settings.

## Alarm

**Alarm Mode:**

Recording Quality: Super ▼

Recording Frame Rate: 30 ▼

Recording Time: 30 ▼

Pre-Record: ON ▼

Set      Get Current Settings

In this page, users can adjust the options for Alarm Mode, including Recording Quality, Recording Frame Rate, Recording Time, and Pre-Record.

Click Set to apply changes, and press Get Current Settings to retrieve current DVR settings.

## Motion

**Motion Mode:**

Recording Quality: Super ▼

Recording Frame Rate: 30 ▼

Recording Time: 10 ▼

Pre-Record: ON ▼

Set      Get Current Settings

In this page, users can adjust the options for Motion Detection, including Recording Quality, Recording Frame Rate, Recording Time, and Pre-Record.

Click Set to apply changes, and press Get Current Settings to retrieve current DVR settings.

## ***Auto Log Setup***

In this section, users can set Auto Log Setup for DVR to keep records of Motion Detection, Alarm Input, Power On, and Record On, etc.

## Auto Log Enable

Motion Detection:  ON  OFF

Alarm Input:  ON  OFF

Power On:  ON  OFF

Record On:  ON  OFF

Record Off:  ON  OFF

Video Loss:  ON  OFF

HDD Fail:  ON  OFF

HDD Full:  ON  OFF

Users can enable / disable each option. Click Get Current Settings to retrieve current DVR settings, and Press Set to apply changes.

## Auto Log List

No.	Source		Channel	Type	Time
	IP	Device Name			
1	192.168.1.192	Video Server			
2	192.168.1.192	Video Server			
3	192.168.1.192	Video Server			
4	192.168.1.192	Video Server			
5	192.168.1.192	Video Server			
6	192.168.1.192	Video Server			
7	192.168.1.192	Video Server			
8	192.168.1.192	Video Server			
9	192.168.1.192	Video Server			
10	192.168.1.192	Video Server			
11	192.168.1.192	Video Server			
12	192.168.1.192	Video Server			
13	192.168.1.192	Video Server			
14	192.168.1.192	Video Server			
15	192.168.1.192	Video Server			
16	192.168.1.192	Video Server			

The log of DVR operations will be kept in this page.

## Central Management System (Only For DIGI-VIEW4PROM)

CMS is the software that manages up to four DVRs in one screen at the same time. The installation file of CMS is in the CD provided with DVR. Click CMS (Central Management System) on the menu to run installation procedure.

After installation, double click CMS icon to run it.



A login window will pop up and ask for Account and Password. The default account and password is **root/root**.

When correct account/password is entered, the main screen of CMS will show up.

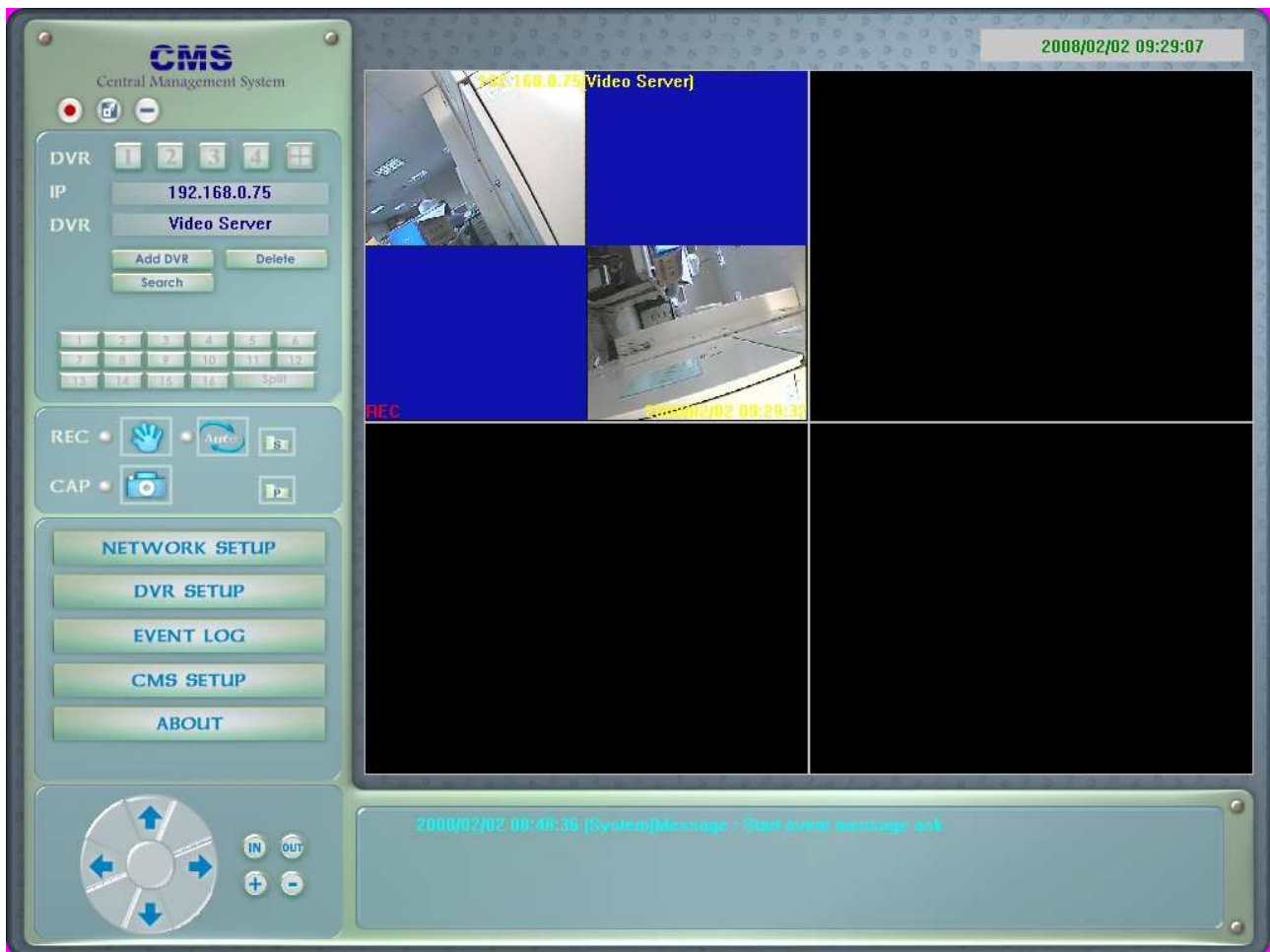

### Basic Controls

The time box at the top right corner displays current system time.

2008/02/02 10:36:44

 buttons at the top left corner control respectively Exit CMS, Full Screen, and Minimize to Toolbar.

In the middle of the screen shows the live view of each DVR.

At the bottom of the screen, it is a message panel. Event messages will show here.



## DVR Management Panel



Click  buttons to select each DVR or Quad mode.

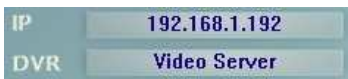

shows current DVR's IP and name.

Click  to add or delete DVR from CMS. Or right click on the live view to achieve it.

An Add DVR window will pop up. Fill the correspondent blanks and click OK to add a DVR. (Default Name and Password is **root/root**)

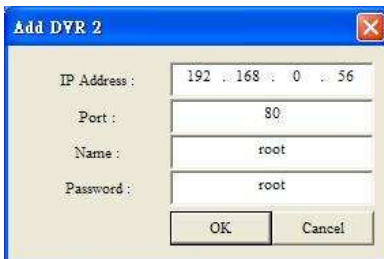

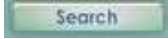
If the DVR and your computer are in the LAN (Local Area Network) environment, use  to search the DVR. After searching, double click on the DVR to add it.

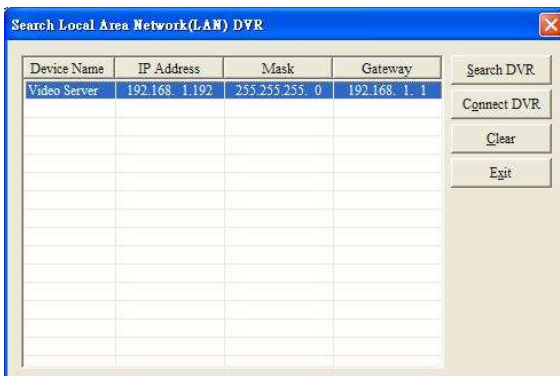



Channel buttons are used to change different channels or split display.

## Recording and Capturing Panel



CMS records video immediately when this button is pushed.



CMS uses time table to record video.



Press this button to see the time table and arrange recording schedule.



Press this button to snap an image.



Set the destination path for recording and capturing images. (The folder will be STORAGE.)

## Configuration Panel



### Note:

If the DVR is in MENU pages, the changes of settings on CMS will **NOT** be applicable to the DVR.

In this panel, users can change settings for DVR, including Network Setup, DVR Setup, and CMS Setup.

## Network Setup

In network setup section, remote DVR's network relevant settings can be changed. Please refer to TCP/IP Setup at Page 38.

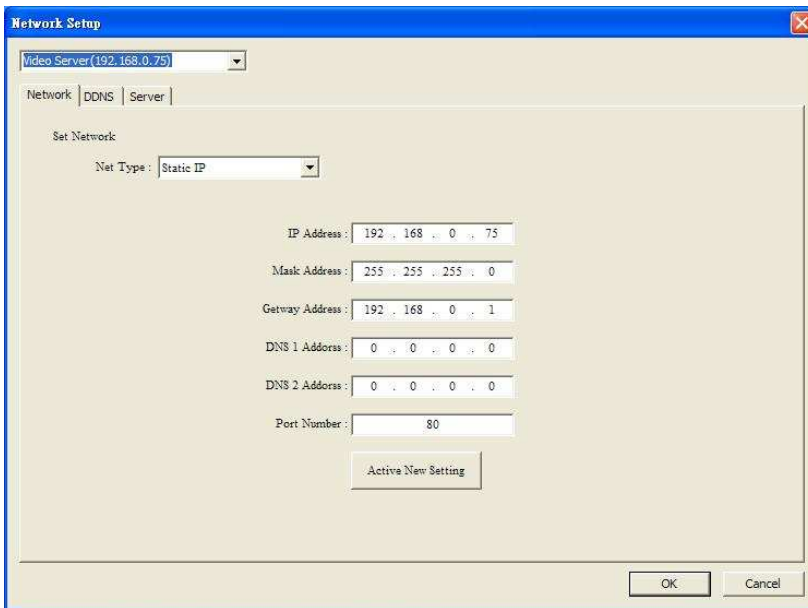

Users can change the connection types, IP address, mask address, and so on for DVRs.

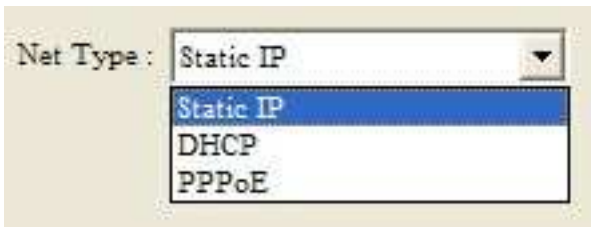

If DHCP is applicable in the network environment, users can check DHCP Enable box and push Active New Setting button to set DVR using DHCP.



If the network environment is using PPPoE, users can enter the ID and password in the PPPoE setting page. To apply settings, check PPPoE Enable box and press Active New Setting button.

Network | DDNS | Server

Set Network

Net Type:

PPPoE User ID:

PPPoE Password:

IP Address:

Mask Address:

Gateway Address:

DNS 1 Address:

DNS 2 Address:

PPPoE Enable

Active New Setting

In DDNS page, users can set up DDNS for the DHCP (dynamic IP) environment. (Please refer to DDNS Setting at Page 83.)

Network | DDNS | Server

Set DDNS

Domain:

User ID:

Password:

DDNS Enable

Active New Setting

In Server page, users can set administrator and user account in the Set User page,

Network | DDNS | Server

Set Server

Server:

Admin:

Admin Password:

Admin Reconfirm:

User:

User Password:

User Reconfirm:

Active New Setting

upload firmware and reset default setting in the Set System page,



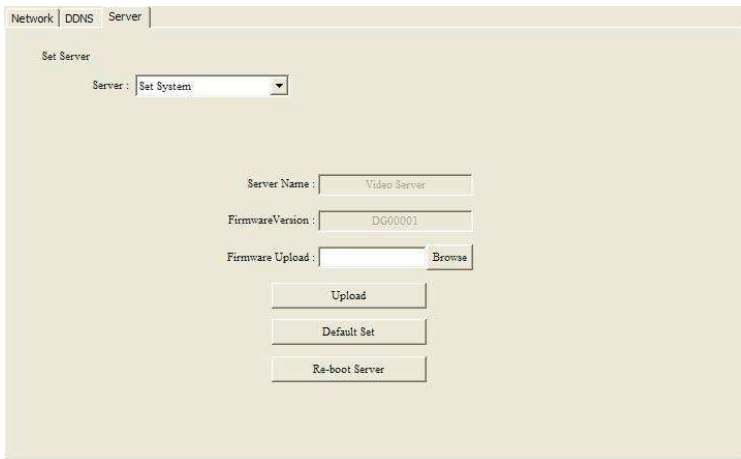

and set email address for notification in the Set E-Mail page.



## DVR Setup

In this section, users can see several pages and are able to change the options for DVRs.

### Time

DVR date / time can be changed here.

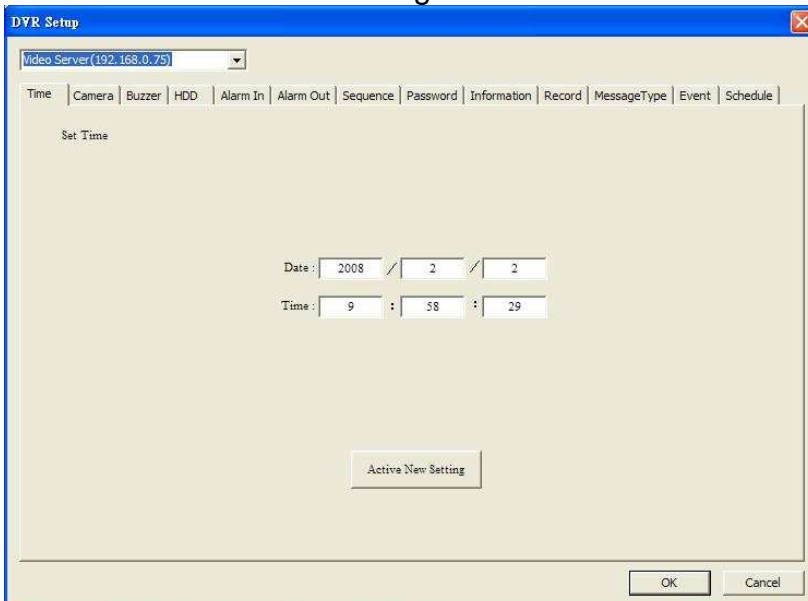

## Camera

Users can modify each channel's title, brightness, contrast, saturation, and hue. By clicking Default, all settings in this page return to factory default values.

Time | Camera | Buzzer | HDD | Alarm In | Alarm Out | Sequence | Password | Information | Record | MessageType | Event | Schedule

Set Camera

Channel ID : 01

Title : CAM1

Brightness : 32

Contrast : 42

Saturation : 38

Hue : 32

Default

Active New Setting

## Buzzer

Users can enable/disable buzzer for key beep, motion detection, power on, alarm trigger, and video loss. The beeping length can be changed as well.

Time | Camera | Buzzer | HDD | Alarm In | Alarm Out | Sequence | Password | Information | Record | MessageType | Event | Schedule

Set Buzzer

Key Beep Buzzer     Motion Buzzer

Power ON Buzzer     Alarm Buzzer

Video Loss Buzzer

Beep Time : 1

Active New Setting

## HDD

HDD shows the information on the hard drives in DVR. The recording mode can be changed to either Recycle or Once.

Time | Camera | Buzzer | HDD | Alarm In | Alarm Out | Sequence | Password | Information | Record | MessageType | Event | Schedule

Set HDD

HDD 1 Information : Model : ST3400832A

Size : 400.0 (GB)

Free Size : 371.5 (GB)

HDD 2 Information : Model :

Size : (GB)

Free Size : (GB)

Record Mode : Recycle

Active New Setting

## Alarm In

In this page, users can change the settings for the alarm input.

Time | Camera | Buzzer | HDD | Alarm In | Alarm Out | Sequence | Password | Information | Record | MessageType | Event | Schedule

Set Alarm In

Alarm In Number : 01

Alarm Status : N.O

Alarm Out 1    Alarm Out 3

Alarm Out 2    Alarm Out 4

Alarm Full

Active New Setting

## Alarm Out

Users can set the settings for alarm output.

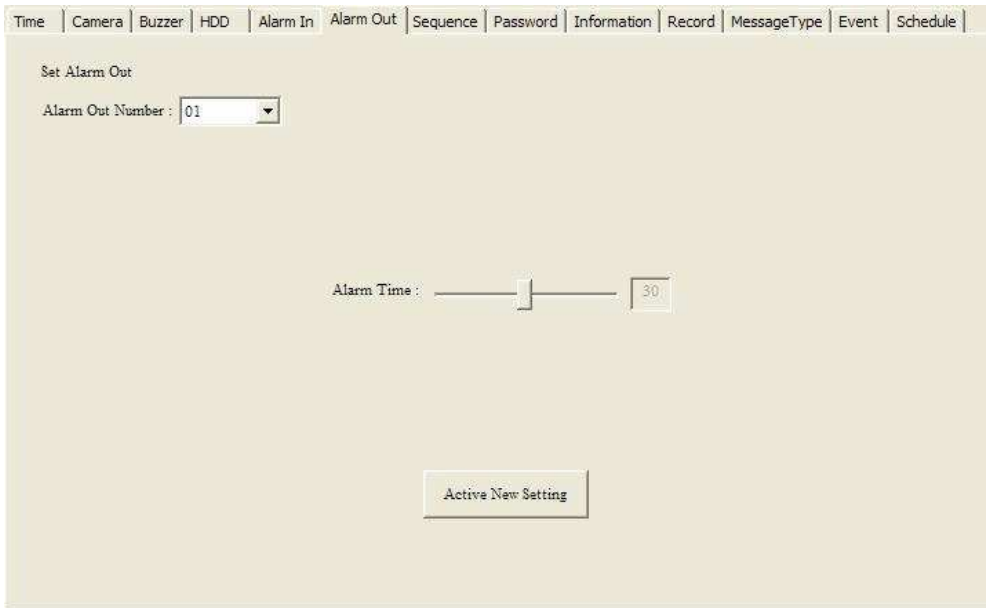

### Sequence

Sequence is the interval between cycling each channel. The available values are from 1 second to 60 seconds.

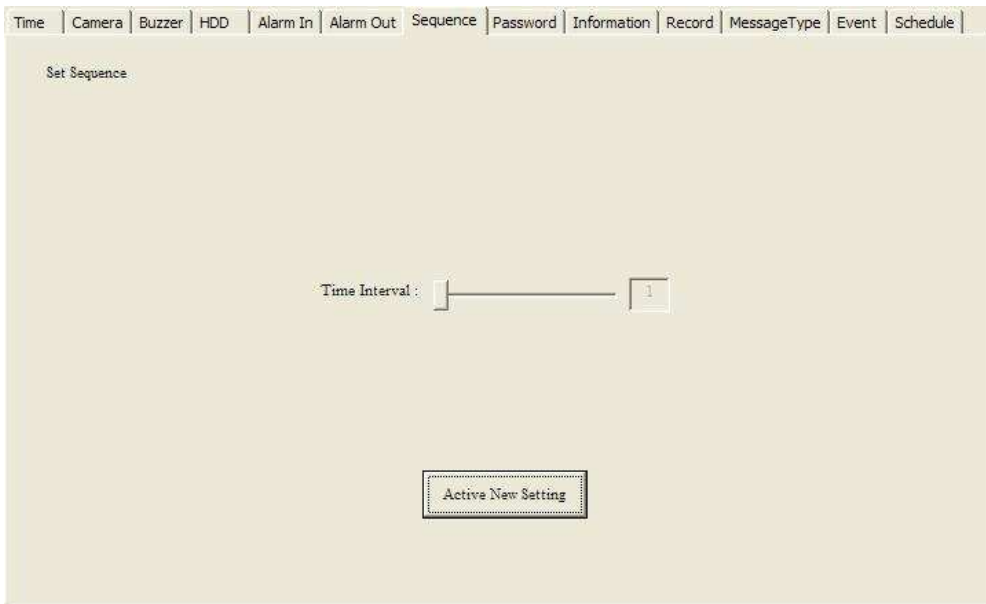

### Password

Users can change the key-lock password for the DVR. Please note that only digits are acceptable. The password length should be 4 digits.

Time	Camera	Buzzer	HDD	Alarm In	Alarm Out	Sequence	Password	Information	Record	MessageType	Event	Schedule
------	--------	--------	-----	----------	-----------	----------	----------	-------------	--------	-------------	-------	----------

Set Password

New Password :

Confirm :

( Number 0 ~ 9 only )

### Information

Information page shows the firmware version of the DVR, and users can click Set DVR to Default to have the DVR return to factory default settings.

Time	Camera	Buzzer	HDD	Alarm In	Alarm Out	Sequence	Password	Information	Record	MessageType	Event	Schedule
------	--------	--------	-----	----------	-----------	----------	----------	-------------	--------	-------------	-------	----------

Set Information

Stork Light Version :

Merlin Version :

Jays Version :

### Record

Users are able to adjust the compression format, recording frame rate, quality and recording length. Options to enable/disable pre-record for motion detection and alarm trigger are available.

Time | Camera | Buzzer | HDD | Alarm In | Alarm Out | Sequence | Password | Information | Record | MessageType | Event | Schedule

Set Record

	Format	Frame Rate	Quality	Record Time	Pre Record
Continuous :	JPEG	30	Super		
Motion :	JPEG	30	Super	30	<input checked="" type="checkbox"/>
Alarm :	JPEG	30	Super	30	<input checked="" type="checkbox"/>

Active New Setting

### Message Type

Users can choose which messages will be sent to the email account when it's triggered.

Time | Camera | Buzzer | HDD | Alarm In | Alarm Out | Sequence | Password | Information | Record | MessageType | Event | Schedule

Set Message Type

<input checked="" type="checkbox"/> Motion Detection	<input checked="" type="checkbox"/> Record Off
<input checked="" type="checkbox"/> Alarm In	<input checked="" type="checkbox"/> Video Loss
<input checked="" type="checkbox"/> Power On	<input checked="" type="checkbox"/> Hard Disk Fail
<input checked="" type="checkbox"/> Record On	<input checked="" type="checkbox"/> Hard Disk Full

Active New Setting

### Event

This page displays the event log on the DVR.

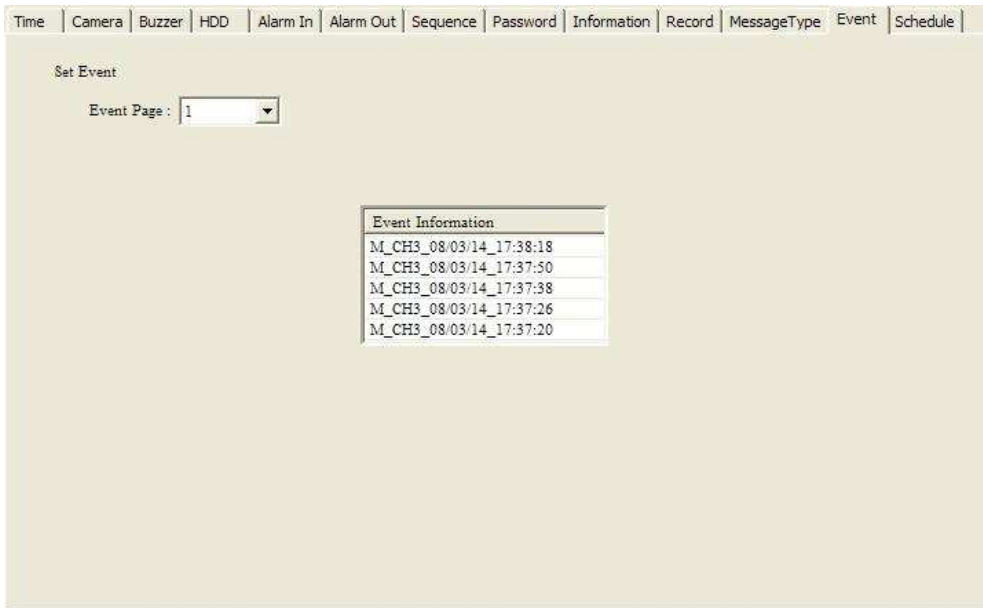

### Schedule

Recording schedule can be arranged in this page. Click any cell and type C, M, A, or N to assign value. C is for Continuous, M for Motion Detection, A for Alarm, and N for None.

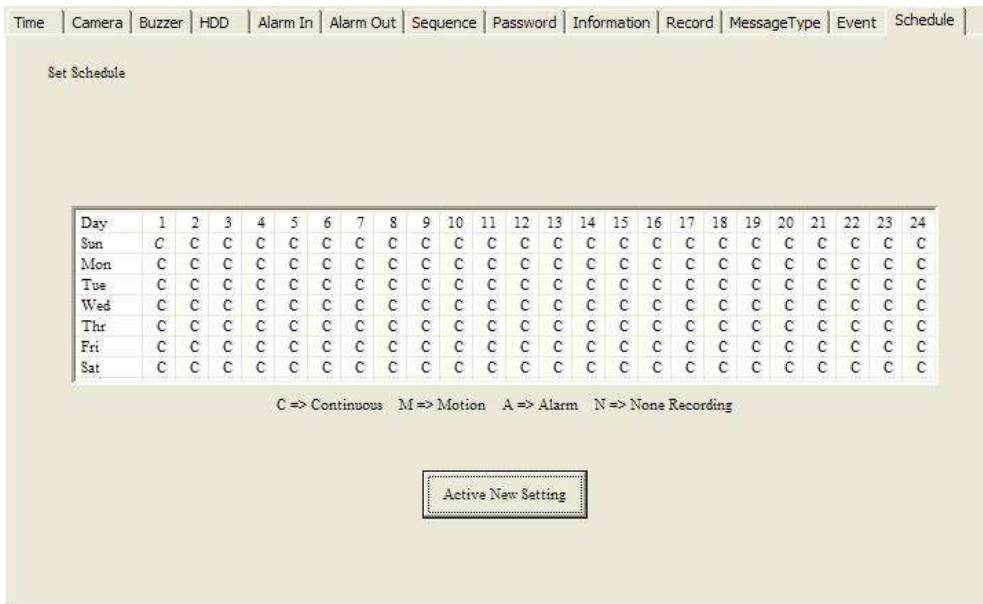

### Event Log

Event log keeps all records happening on DVRs.

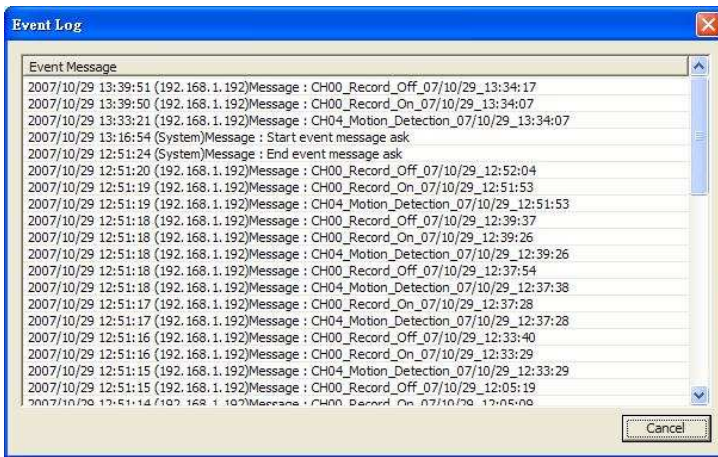

## CMS Setup

CMS login account can be changed here by filling Account, Password, and Confirm.











## About

About shows the version and released date of CMS.

## PTZ Panel



When the cameras support PTZ control, users can manage them in this panel.





 are used to pan,
 

 are used to tilt, and
 

 are used to zoom in and zoom out.

## Playback

Users can review the playback with CMS. Right click on any channel of the live view, and it shows the menu. Choose Playback to proceed.





There is a popup window of operating panel for playback.

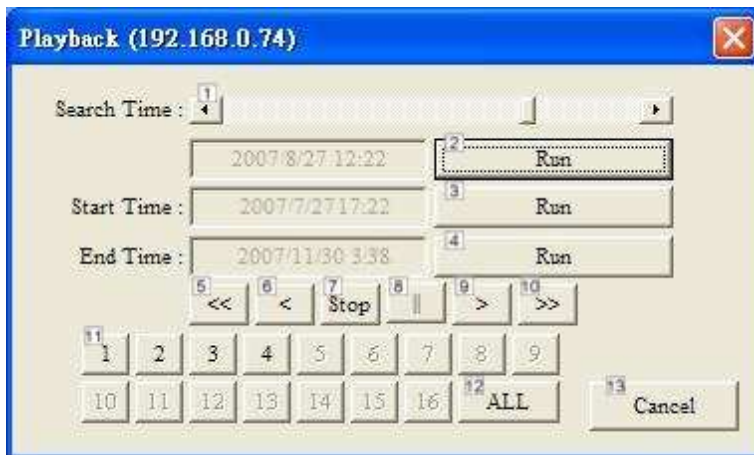

1. Search Time: Scroll to a specific time point.
2. Run (under Search Time bar): Start to play playback of the specific time point.
3. Run (Start Time): Play playback from the very beginning of the recording.
4. Run (End Time): Play playback from the end of the recording.
5. <<: Change rewinding speed from 2x, 4x, and 8x.
6. <: Rewind at normal speed.
7. Stop: Stop playback and show the live view.
8. ||: Pause.
9. >: Play playback at normal speed.
10. >>: Change playing speed from 2x, 4, and 8x.
11. 1, 2, 3, ...,16: Select certain channel for playback.
12. ALL: See all channels.
13. Cancel: Stop playback and return to the live view. Quit the popup window.

## DVR Finder (Only for DIGI-VIEW4PRON)

DVR Finder is a program that searches all the DVRs in the LAN. Please insert the CD provided with the pack, and click DVR Network Finder to install.



Click DVRFinder icon on the desktop to run the program.

After pressing Search DVR button, it shows all the DVRs found in the LAN.

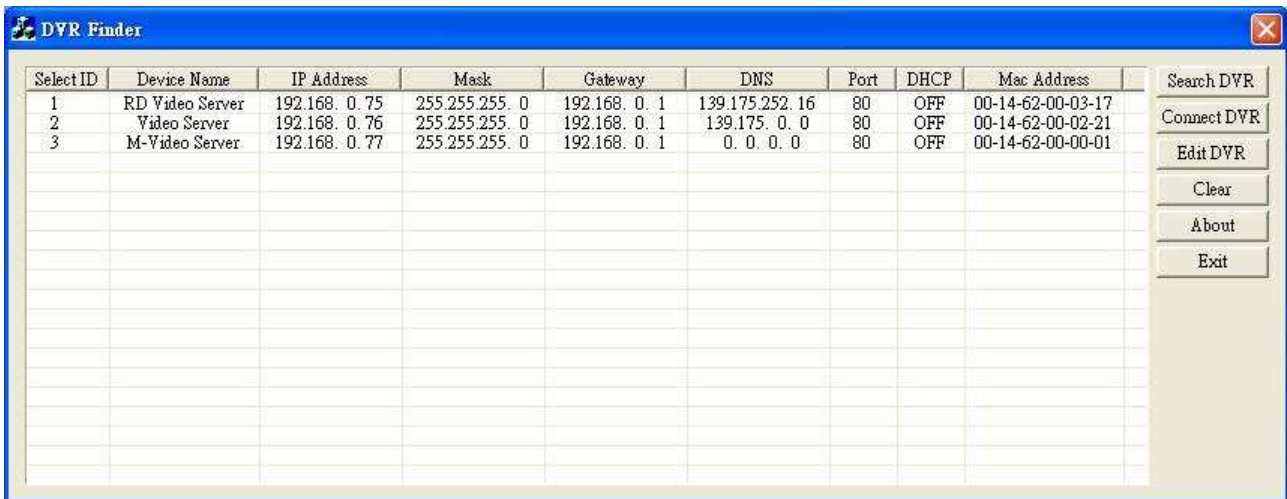

Users can select any DVR in the table, and press Connect DVR button to connect to the DVR by the IE browser.

Users are able to change the network settings by pressing Edit DVR button.



Clear button is to clear the table of all DVRs found in the LAN.

About button shows the version of DVR Finder.

Exit button is clicked to close the program.

## DDNS (Only for DIGI-VIEW4PRON)

DDNS (Dynamic DNS) provides dynamic domain names for dynamic IP users. It translates domain names to dynamic IP address. Dynamic IP users can use DDNS to get access to their computers without memorizing the IP.

This DVR supports DynDNS (<http://www.dyndns.com/>) DDNS service.

The screenshot shows the DynDNS homepage. At the top, there's a navigation bar with the DynDNS logo and links for 'DynDNS.com', 'Dynect', 'TLDDNS', and 'Corporate'. Below this is a secondary navigation bar with tabs for 'About', 'Services', 'Account', 'Support', and 'News'. A '10 Years!' anniversary badge is also present. The main content area features a large banner with the text 'BE THE KING IN YOUR CASTLE' and 'Many more Dynamic DNS domains now available.' To the right of the banner are four service categories: 'DNS Services' (DNS for static and dynamic IP addresses), 'MailHop Services' (Ensure reliable mail delivery), 'Network Monitoring' (Monitor your online services, 24x7x365), and 'SSL Certificates' (High quality digital certificates). Below the banner is a news ticker with the headline 'FIRST PowerKnights Team 501 Gets Power Boost from Local Business'. At the bottom, there are four columns of links: 'Resources' (What is DNS?, Home Solutions, Business Services), 'Services' (Custom DNS, Dynamic DNS, E-Mail Relay), 'Support' (Update Clients, 24/7 Premier Support, Developer's Info), and 'About Us' (Search, DynDNS Careers, Contact Us).

To use DDNS service, we have to create an account first. Click Create Account under the Login button.

The screenshot shows the 'Dynamic DNS' service page on the DynDNS website. At the top, there's a login form with 'User:' and 'Pass:' input fields and a 'Login' button. Below the login form are links for 'Lost Password?' and 'Create Account'. The main content area is titled 'Dynamic DNS' and describes the service. It includes a 'Get Started' button and a 'Manage Hosts' button. Below these is a 'Screenshot' section with a small image. The 'Capabilities and Features' section lists several benefits: 'Get five (5) hostnames in 88 available domains for free.', 'Create wildcard CNAME \*.yourhost.dyndns.org for yourhost.dyndns.org.', 'Forward web requests or mark host offline for maintenance or downtime.', 'Configure MX records for flexible mail routing.', 'Update host using ddns update clients for a wide variety of platforms.', 'Modify DNS TTL values for fast propagation or reliable static IP caching.', and 'Deliver your DNS records to 5 DNS servers in 5 tier-1 datacenters around the globe.' At the bottom, there's a 'Documentation' section with a search bar.

Complete the form and click Create Account button at the bottom to finish the process.

DynDns will send an email to you. Click the link in the email and account creation process is complete.

The screenshot shows the DynDNS website's account creation page. The header includes the DynDNS logo and navigation links for About, Services, Account, Support, and News. A sidebar on the left contains links for My Account, Create Account, Login, and Lost Password, along with a search box. The main content area is titled 'Create Your DynDNS Account' and contains a form with the following fields: Username (Eugene), E-mail Address (eugene@digiview-security.com), Confirm E-mail Address (eugene@digiview-security.com), Password (\*\*\*\*\*), and Confirm Password (\*\*\*\*\*). There are also optional fields for 'How did you hear about us?' (From a DynDNS user) and 'Details'. A disclaimer states: 'We do not sell your account information to anyone, including your e-mail address.'

Login with your account and go to Services page. Click Dynamic DNS link.

The screenshot shows the DynDNS Services page. The header includes the DynDNS logo and navigation links for About, Services, Account, Support, and News. A sidebar on the left contains links for Services, DNS Services, Domain Registration, SSL Certificates, MailHop Services, Network Monitoring, URL Forwarding, Pricing, and My Cart (0 items). The main content area is titled 'Services' and contains a description of the services: 'We offer you superior domain name services (DNS), high quality domain management, world-class e-mail services, web redirection, and network monitoring. All of our services include free technical support by e-mail or phone where you speak to a highly trained engineer rather than a call center reading a script off of a screen.' Below this is a section titled 'DNS Services' with four icons and descriptions: Dynamic DNS (A free DNS service for those with dynamic IP addresses.), Custom DNS (Our dynamic and static DNS management tool for your own domain.), Recursive DNS (Ensure DNS resolution for your DNS queries.), and Secondary DNS (Add reliability to your own nameservers.).

In this page, it shows the description of Dynamic DNS. After reading the information, click Get Started to set up a Host Name for your IP address.



DynDNS.com > Dynect > TLDDNS > Corporate

Logged In User: EugeneHuang  
[My Services](#) - [My Cart](#) - [Log Out](#)

About Services Account Support News

## Dynamic DNS

Dynamic DNS (DDNS) allows you to create a hostname that points to your dynamic IP or static IP address or URL. We also provide an update mechanism which makes the hostname work with your dynamic IP address. **We continue to offer this service free** to the Internet community as we have done so for **nearly 10 years**.

**Capabilities and Features**

- Get five (5) hostnames in [88 available domains](#) for free.
- Create wildcard CNAME `*.yourhost.dyndns.org` for `yourhost.dyndns.org`.
- Forward web requests or mark host offline for maintenance or downtime.
- Configure MX records for flexible mail routing.
- Update host using [ddns update clients](#) for a wide variety of platforms.
- Modify DNS TTL values for fast propagation or reliable static IP caching.
- Deliver your DNS records to 5 DNS servers in 5 tier-1 datacenters around the globe.

Our **free industry-leading e-mail support** is ready to help you setup your dynamic or static DNS so you can host a website, remotely connect to your machine, and run a mail server. We also offer other premium features with our [Account Upgrade](#) service.

[Get Started](#)  
[Manage Hosts](#)

**Screenshot**

Type the hostname you like, and choose a domain name. Click Use auto detected IP address link, it fills your current IP automatically.

Logged In User: EugeneHuang  
[My Services](#) - [My Cart](#) - [Log Out](#)

About Services Account Support News

## Add New Hostname

Note: You currently don't have Account Upgrades in your account. You cannot use some of our Host Service features. Please consider buying Account upgrade that make this form full-functional and will add several other features. [Learn More...](#)

**Host Services**

Hostname:  .

Wildcard:  Yes, alias "\*.hostname.domain" to same settings.

Service Type:  Host with IP address  
 WebHop Redirect  
 Offline Hostname

IP Address:   
[Use auto detected IP address 220.130.57.66](#)  
TTL value is 60 seconds. [Edit TTL](#)

Mail Routing:  Yes, let me configure Email routing.

[Create Host](#)

Finally, press Create Host to finish the process.

Logged In User: EugeneHuang  
[My Services](#) - [My Cart](#) - [Log Out](#)

About Services Account Support News

My Account

My Services

- Account Upgrades
- SLA
- Premier Support
- Zone Services
- Host Services
- MailHop Outbound
- Recursive DNS
- Network Monitoring
- SSL Certificates
- Renew Services
- Auto Renew Settings
- Sync Expirations

Account Settings

Billing

My Cart [0 items](#)

### Host Services

[Add New Hostname](#) - [Host Update Logs](#)

Hostname [digiview.dvrDNS.org](#) created.

Hostname	Service	Details	Last Updated
<a href="#">digiview.dvrDNS.org</a>	Host	220.130.57.66	Oct. 29, 2007 5:07 AM

Now you are able to access your IP by using Hostname.domain. In this example, digiview.dvrDNS.org is mapped to 220.130.57.66.

In DVR Internet Operation (Please refer to Page 61), go to Network Setup->Network. Choose DDNS and fill the following form. After setting, you can use the domain name to get to DVR.

DDNS State:  ON  OFF

Domain Name:

User ID:

Password:

# Appendix

## *Troubleshooting*

- 1. The DVR cannot detect the hard disk drive (the screen shows HDD NOT FOUND).**  
Make sure the IDE cable and power cable are connected properly to the hard drive. Turn on the DVR without connecting CCTV Cameras first. It may be caused by consuming too much power and leads to malfunction of the HDD.
- 2. There is no image from the cameras.**  
Make sure the cameras are working all right by connecting them to a CRT monitor directly. The DVR can only provide a total 2A current to the cameras. If the camera consumes too much power, please use an individual power for it.
- 3. The image is incorrect (twisted or flickering).**  
Make sure the NTSC/PAL setting is set in accordance with the local power system. Go to MAIN MENU->CAMERA VIDEO SETUP->NTSC/PAL SETUP to adjust.
- 4. There is no image on the IE browser when connected to the DVR.**  
Please install the ActiveX plug-in AVMonitor for IE. It can be found in the CD provided with the pack.
- 5. When connected to the DVR, the IE browser / CMS shows “disconnect” directly.**  
The DVR supports maximum four connections at the same time. When the connection is full, the IE browser or CMS will show “disconnect” directly.
- 6. I forget the password of the DVR.**  
The universal password is 5785 (Quad, SEQ, Pause, Quad).  
Use the universal password to enter, and change the password right away.
- 7. I forget the ID/password for the IE / CMS connection.**  
The universal ID/password for the IE/CMS login is 1111/1111.
- 8. The remote control does not work.**  
The operating distance from the DVR to the remote control is around five meters. Please use it within five meters away from the DVR.  
If it does not work within the distance, the remote control is out of battery. Please change a new battery.
- 9. I am using a router to share network, but the DDNS function does not apply.**  
The DDNS function is used with DVR connecting to PPPoE or public dynamic IP directly. If the DVR is working under a router, the DDNS settings should be applied in the router.
- 10. What is the default password for the DVR?**  
The default password for the DVR is 0000 (press ■ four times).  
The default ID/password for network administrator is root/root, for users is user/user.

# Technical Support

**0121 7861881**



**ELECTRONICS LINE UK LTD (ESP)**

ADDRESS: UNIT 7 LEVISS TRADING ESTATE, STATION ROAD,  
STECHFORD, BIRMINCHAM, B33 9AE, UK

TEL: 0121 7898111      FAX: 0121 6030333

[www.espuk.com](http://www.espuk.com)

