

# Digital Surveillance System

## Triplex Standalone DVR

### User's Manual (V2.1)

### Table of Contents

<b>Precautions for safety</b> .....	<b>2</b>
<b>Package Content</b> .....	<b>2</b>
<b>DVR Introduction</b> .....	<b>2</b>
1. Product Overview.....	3
2. Front Panel.....	3
3. Rear Panel.....	4
4. IR Remote Controller(Optional).....	5
<b>System Setup and Installation</b> .....	<b>5</b>
1 Hard Disk Drive Installation.....	5
1.1 Install the internal hard disk drive.....	5
1.2 Install DVD±RW or mobile rack for removable hard disk drive.....	6
2 Video Format Selection.....	6
3 Monitor Connection.....	6
4 Camera Connection.....	7
5 USB & PS/2 Connection.....	7
6 Sensor Installation.....	7
7 Alarm Installation.....	8
8 Network Connection.....	8
<b>Getting Start Operation</b> .....	<b>9</b>
1. Start Up the DVR System.....	9
2. Main Screen.....	9
3. Set Up.....	10
3.1 Log In.....	10
3.2 Camera Setting.....	10
3.3 Record Setting.....	10
3.4 Sensor Setting.....	11
3.5 Motion Detection Setting.....	11
3.6 Screen Adjustment.....	12
3.7 Audio Setting.....	12
3.8 System Setting.....	12

3.8.1	Hard Disc Setup.....	12
3.8.2	Password Change.....	13
3.8.3	Time Set.....	13
3.8.4	Event List.....	13
3.8.5	Network.....	14
3.8.6	RS-485.....	15
3.8.7	Pan/Tilt/Zoom Device.....	15
3.8.8	Firmware Upgrade.....	15
3.8.9	Load Active-X Control.....	15
3.9	Video Search.....	15
3.10	Language Selection.....	15
3.11	Save System Setup.....	16
3.	Playback.....	16
4.	Back Up.....	16
4.1	Back up via USB flash disc.....	16
4.2	Back up via internal CD-RW or DVD±RW Drive.....	16
<b>Player and Remote Monitoring.....</b>		<b>17</b>
1	Triplex Viewer – Player.....	17
1.1	Main function menu& Display Screen.....	17
1.2	Play back with saved video data.....	18
1.3	Convert Video Format as standard AVI format.....	19
2	Triplex Viewer – Net Viewer.....	20
2.1	Main function menu& Display screen.....	20
2.2	Connect PC to DVR through local area network (network hub).....	20
2.3	Connect PC to DVR through cross-over cable.....	21
3	Remote Monitoring through IE Browser.....	22
4	DDNS Setup.....	24
Appendix A – Recommended HDD.....		26
Appendix B – Record Time Table.....		27
Appendix C – Camera Installation Guide.....		27

## **Copyright Notice**

All rights reserved. No part of this specification may be reproduced or transmitted in any form or by any means, or any information storage and retrieval system. No patent rights or licenses to any of the circuits described herein are implied or granted to any third party.

## **Precautions for Safety**

- For your safety, unplugging the power before moving the DVR, installing, or replacing any parts or hard drive.
- Keep DVR in a well-ventilated place and away from any heat generating object.
- Do not install the equipment in a location subject to direct sunlight, or a location near heat sources.
- Keep the DVR in a temperature ranging 5 ~ 45 , avoid a place of high temperature and humidity.
- Avoid mechanical shock to the equipment.
- If you are not sure of the installation and setup, please consult the technicians.

## **Package Contents**

1. Triplex Standalone DVR Series DVR Main Unit
2. Power Adaptor & AC Power Cord
3. Software & User Manual CD for Installation
4. Optional Choice
  - CD-RW/DVD±RW
  - Mobile Rack
  - Remote Controller with AAA battery \* 2
  - PS/2 Mouse for 4ch and 8ch, USB Mouse for 16ch



**If there is any damage, shortage or inappropriate item in package, please contact with your local dealer.**

The packing contents may verify by the region, please refer to the description on package or confirm with your local dealer.

## DVR Introduction

### 1、 Product Overview

Triplex Standalone DVR series is a triplex digital video recorder (DVR) system. It adopts a digital image compression technology to compress the input channel video streams, and uses HDD to record the compressed video stream. Triplex Standalone DVR provides up to 16 channels and multiplex functionality. The features of this equipment are as below:

1. True Triplex Functionality Simultaneously - Playback/ Record/ Network/ Back-up at the same time.
2. Individual frame rate setting for each channel.
3. Show Video loss/Sensor trigger in event List.
4. RS-485 interface for PTZ Camera control.
5. Easy Firmware Upgrade and back-up via USB flash disc.
6. Multi-user remote control DVR by network.
7. Friendly User Interface

Triplex Standalone DVR series consist 3 product lines of 4, 8 and 16 channels shown as below:

Triplex Standalone DVR series	Basic Function			Optional Function		Optional Case (HDD related)*	
	USB	Network	DI / DO	RS485	VGA	Chassis A	Chassis B
4-channel	USB	Network	DI / DO	RS485	VGA	Chassis A	Chassis B
8-channel							
16-channel							

\*Remark: a) Chassis A supports only one HDD (internal).

b) Chassis B supports Mobile Rack for removable HDD or CD-RW/DVD±RW.

### 2、 Front Panel

Triplex Standalone DVR 4/8-channel with Chassis A

Panel A:

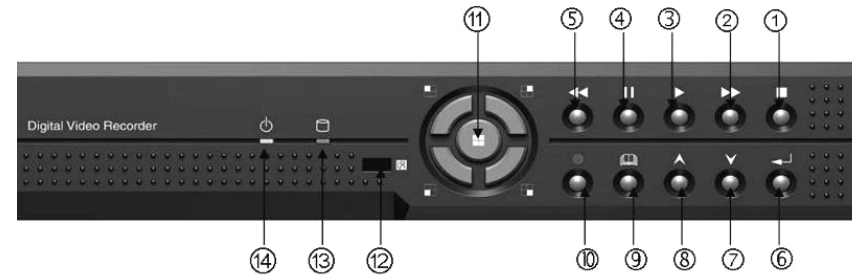

Panel B:

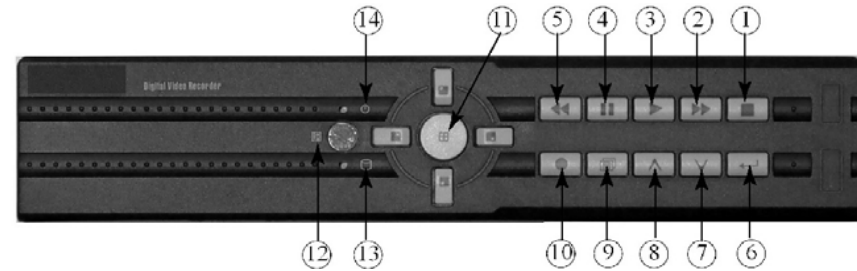

4/8 channel with Chassis B for Removable HDD Rack or CD-RW/DVD±RW Drive



16 channel with Chassis B for Removable HDD Rack or CD-RW/ DVD±RW Drive



### Indicators:

No	Button/Name	Function
1	■ STOP	Stop playback
2	▶▶ FF	Forward playback
3	▶ PLAY	Playback / Enter time search for video playback
4	PAUSE	Pause playback
5	◀◀ REW	Backward playback
6	↶ SELECT / ENTER	To change values on menu.
7	▼ DOWN	Move down through menu list
8	▲ UP	Move up through menu list
9	☰ MENU	Enter or Exit main menu
10	● REC	Start / Stop manual recording (for all channel)
11	⊞ Mode	Display screen by sequence, indicate as below
12	IR Receiver	Remote controller input receiver
13	Red LED Light	Shows HDD is recording or reading
14	Green LED Light	Shows DVR is power-on and running
15	Mobile Rack	For removable HDD or CD-RW/ DVD±RW driver
16	USB PORT (16CH)	Firmware upgrade and back up

### Display sequences indicate:

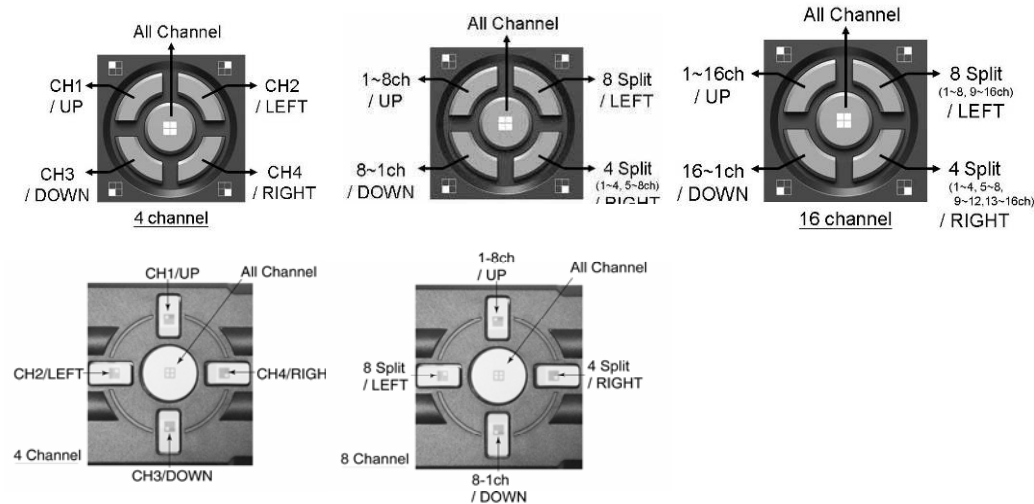

### 3、Rear Panel

#### Triplex Standalone DVR 4/8-channel

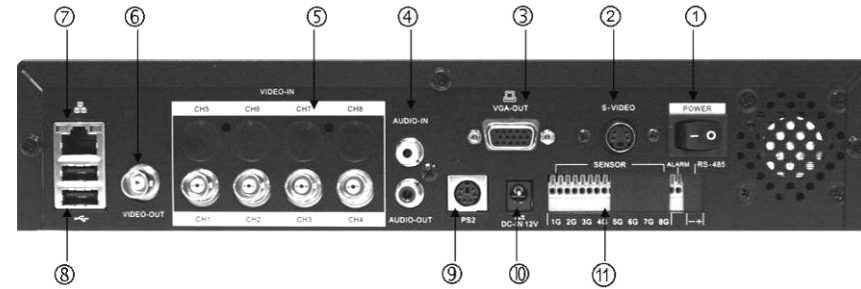

#### Triplex Standalone DVR 16-channel

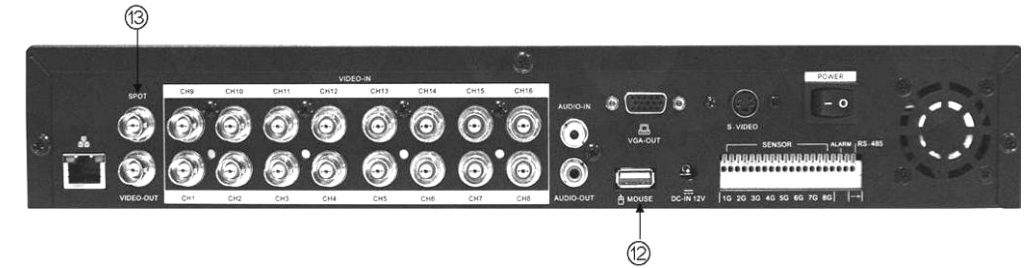

No.	Function
1	Main Power Switch
2	S-Video Out (Monitor)
3	VGA Video Out (Monitor)
4	Audio-In / Audio-Out
5	Video In (BNC)
6	BNC Video Out (Monitor)
7	LAN port
8	USB Port (Dedicated for Firmware upgrade and Back up)
9	PS/2 Mouse Port
10	AC-DC Power Adapter Jack
11	DI/DO for SENSOR / ALARM / RS485 (4 Sensor Input for 4/8ch, 8 Sensor Input for 16ch)
12	USB Mouse Port (16ch only)
13	Spot Out (with auto skip function, 16ch only)

#### 4、 IR Remote Controller

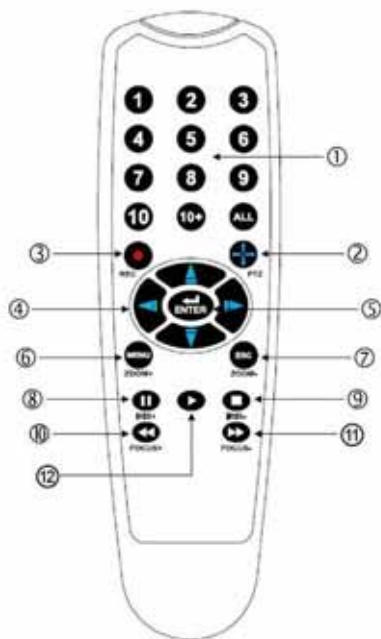

No	Button/Name	Function
1	1~10 (channels)	Channel selector (for CH11~CH16, push 10+ and 1~6 )
2	PTZ	Start PTZ Camera function
3	REC	Start or stop recording
4	▲UP ▼DOWN ◀LEFT ▶RIGHT	Moves Up / Display Sequence 1~16ch Moves Down / Display 8 Split Moves Left / Display Sequence 16~1ch Moves Right / Display 4 Split
5	ENTER	Use this button to change or confirm values on menu setting
6	MENU / ZOOM+	Enter or exit the menu / ZOOM in PTZ camera
7	ESC / ZOOM-	Leave the menu / ZOOM out PTZ camera
8	PAUSE / IRIS+	Pause playback / IRIS+ PTZ camera
9	STOP / IRIS-	Stop playback / IRIS- PTZ camera
10	REW / FOCUS+	Backward search / FOCUS+ PTZ Camera
11	FF / FOCUS-	Forward search / FOCUS- PTZ camera
12	PLAY	Enter time search for playback function

### System Setup and Installation

#### 1、 Hard Disc Drive Installation

##### 1.1 Install the internal hard disc drive

(A) Make sure the DVR power is off before HDD installation

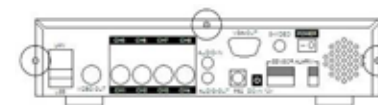

(B) Unlock the screw and open DVR chassis.

(C) For IDE HDD: Plug in the IDE gray cable into IDE connector of main board, and connect the HDD's power cord.

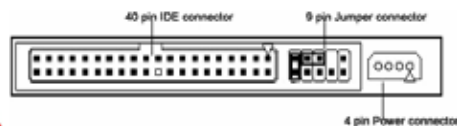

IDE and power cable of HDD, the relative position may different by different manufacture.



**Note: please make sure the HDD jumper setting as "Master", or it might disable DVR function. Before installing HDD, please set jumper as "Master" (The jumper setting varies depends on the hard disc drive manufactures. Refer to manufacture's manual for master jumper setting.**



(D) For SATA HDD:

(D-1) Panel A : Plug in the SATA cable into the SATA connector of the main board, and connect the HDD's power cord.

(D-2) Panel B : HDD Holders and Screws, please fix the 3<sup>rd</sup> hole of HDD holders to HDD driver with screws.



(E) Connect the SATA and power cable to HDD, plug in the SATA cable into the SATA connector of the main board, and connect the HDD's power cord.

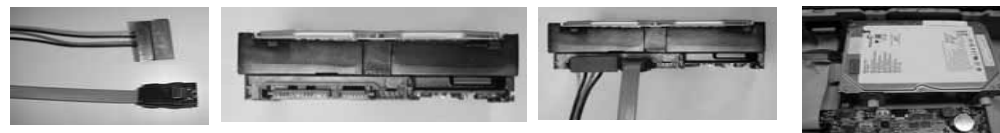

(E) After installing the HDD, slide in the cover chassis and fasten the screw.

## 1.2 Install a CD-RW/DVD±RW or a mobile rack for removable HDD

Chassis B

(A) Firstly, install a HDD into mobile rack, and plug the mobile rack (or CD-RW/DVD±RW) into DVR.

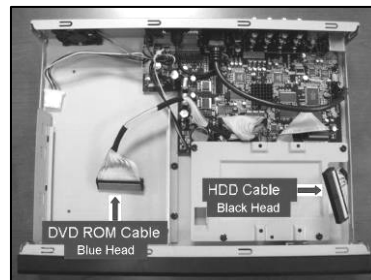

(B) Connect the 1 to 2 IDE cable to main board and mobile rack: Connect one of the black head to main control board; leave another IDE cable with black head for embedded HDD connection. Connect the cable with blue head to the slot of mobile rack (or CD-RW/DVD±RW), also plug in the power cord to mobile rack.



(C) Close the top cover of rack and slide the rack into DVR.

**⚠ Note: If this removable HDD will be treated as master, please make sure the HDD Jumper setting as “Master” and the other HDD embedded in the chassis must set to be “slave” mode.**

The total maximal capacity of HDD for Triplex Standalone DVR series is 1TB for 4/8CH, and 2TB for 16CH, both with a 8MB buffer.

## 2、 Video Format Selection

The DVR accept two video formats: NTSC and PAL, it can be changed by adjusting jumper on main control board.

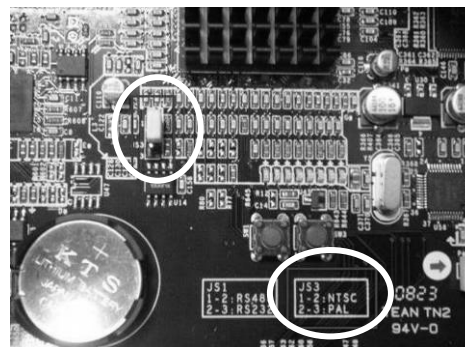

16CH (NTSC/PAL Selector: JS3)

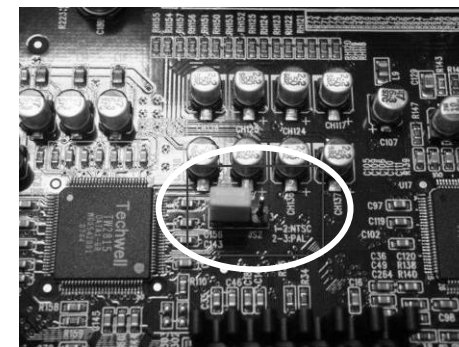

4/8CH (NTSC/PAL Selector: JS2)

## 3、 Monitor Connection

Monitor displays live view image and playback recorded video. For Triplex Standalone DVR, BNC, VGA and S-Video output connectors on rear panel are offered for connecting to monitor.

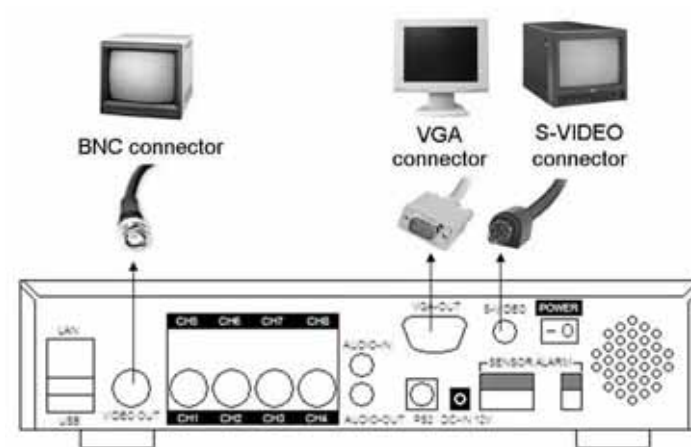

#### 4、 Camera Connection

There are 4 channels for Triplex Standalone DVR-4CH, 8 channels for Triplex Standalone DVR-8CH and 16 channels for Triplex Standalone DVR-16CH for cameras' connection named CH1~CH16. each camera has two wirings basically: BNC and Power.

Connect the BNC cable to DVR's "VIDEO IN" connector on rear panel for video signals and connect the power cable to camera's power adapter.



For Speed Dome Camera installation, connect to RS-485 connectors on rear panel for controls signal.

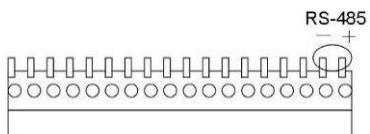

#### 5、 USB & PS/2 Connection

Triplex Standalone DVR series support PS/2 mouse for 4/8CH and USB mouse for 16CH. Connect mouse to PS/2 and USB port on rear panel, also through USB port with USB flash disc, video data could be easy backup.

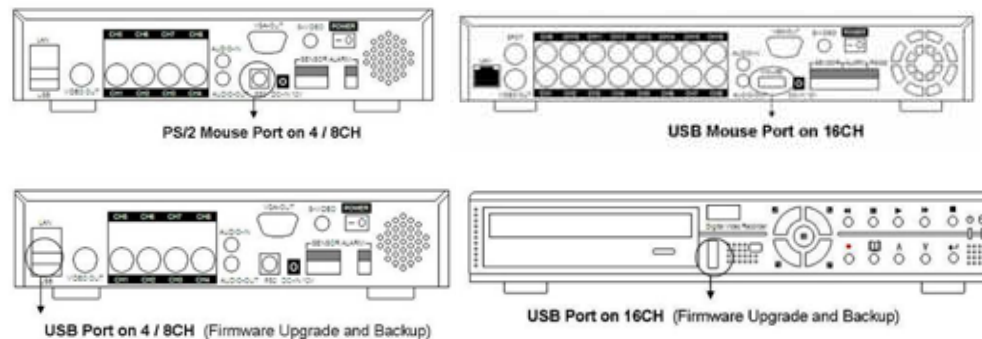

**⚠ Note: For 4/8CH, only one USB port will work, no matter if two flash discs were plugged in.**

#### 6、 Sensor Installation

The DVR unit can be connected up to 4 sensors for Triplex Standalone DVR-4CH, 8 sensors for 8CH/16CH; each set of sensor has two lines include signal line and ground line. Connect the sensor signal lines to signal input terminal on DVR rear panel, and connect the sensor power lines to power source, as figure shown below.

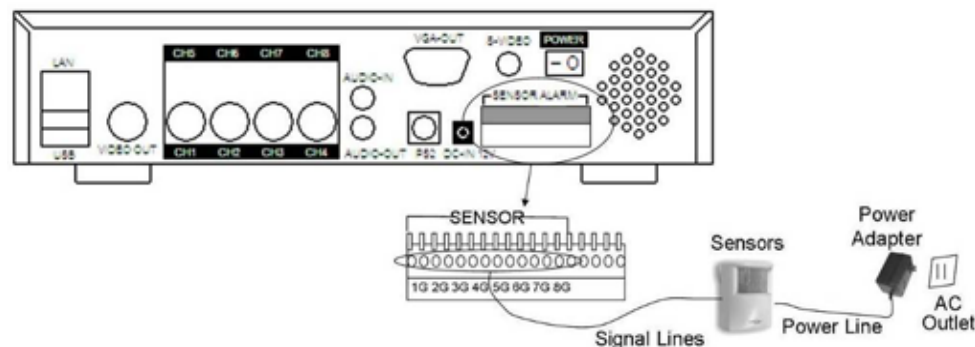

After sensor has installed, you could change the recording mode as "S" on "RECORD SCHEDULE" in the DVR menu to enable sensor recording.

## 7、 Alarm Installation

The DVR has an internal switch for sounding alarm. The switch is normally open, but when the sensor is triggered, the alarm is activated as well.

Connects the alarm signal lines to alarm switch terminal on rear panel and connect the alarm power lines to power source.

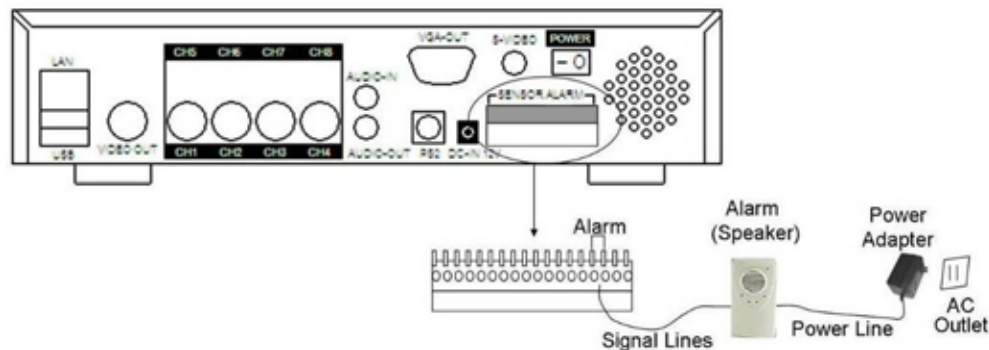

## 8、 Network Connection

Connect the LAN port on rear panel with router for remote monitoring, recording and controlling via internet or local area network.

More network connecting information; please refer the Player and Remote Monitoring chart for Net Viewer setting and remote controlling through IE Browser and DDNS Setup.

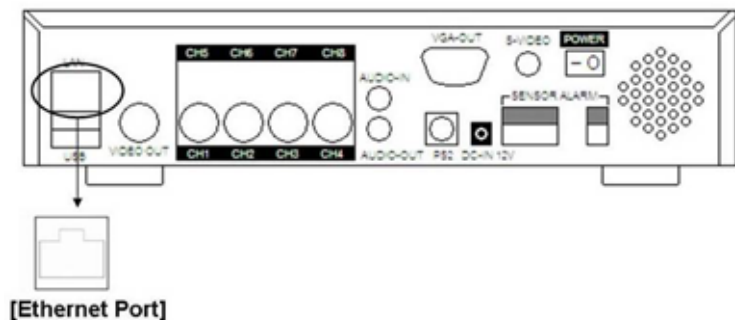

## Getting Start Operation

### 1、 Start Up the DVR System

After the DVR unit and all the peripherals are properly installed, the DVR is ready to record and play. Then apply power and switch on.

After the unit is powered on, the DVR will check HDD for several seconds, and then DVR will enter into real-time display mode.

When installing a new HDD, please press "▶PLAY" to format HDD

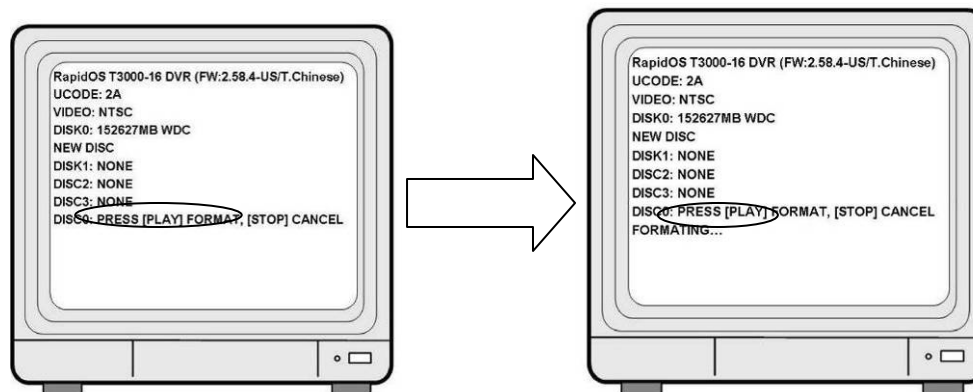

If there is no HDD connected, it will show message as bellow

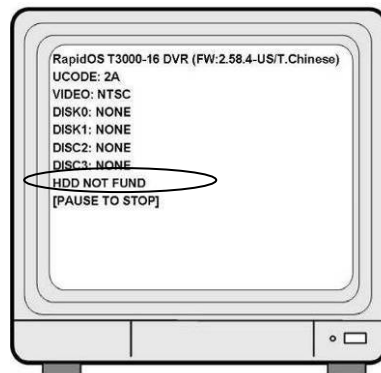



## 2、 Main Screen

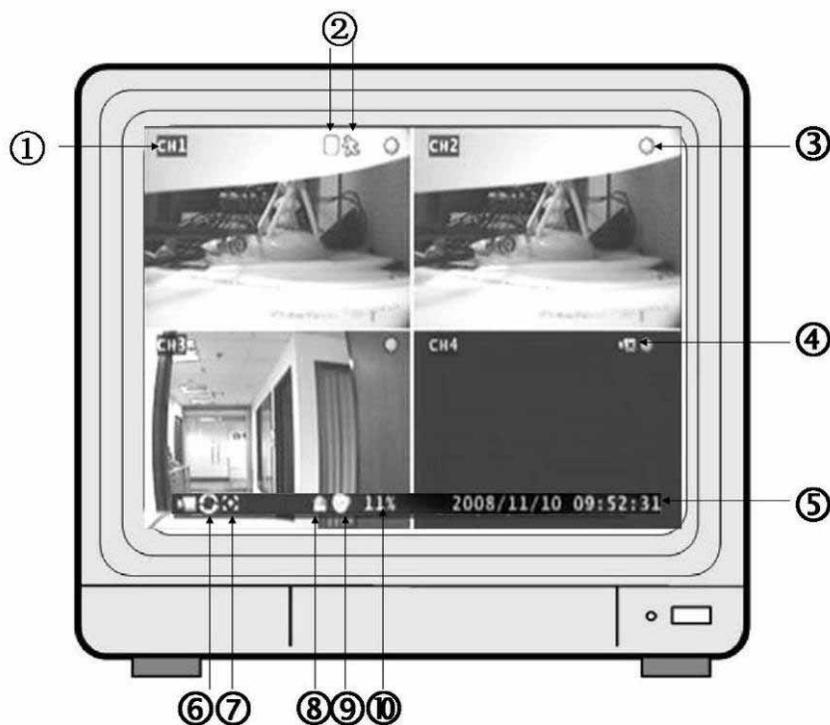

1	CH1	Channel	Display with video channel or video name
2		Recording Mode	Display the indication of recording mode: Sensor and Motion
3		Recording Indicator	Display DVR operating with recording
4		Video Loss	Icon appears with blue screen, the connection with camera not exit
5		Date/Time	Display current date and time
6		Sequence	Icon only shows in single channel, sequences by setting seconds
7		PTZ Adjustment	Display the Zoom/Focus/Iris for PTZ camera
8		Alarm	Display when alarm was triggered as alarm was set opened
9		Buzzer	Display when sensor triggered as alarm by buzzer was opened
10	99%	HDD Capacity	Display total amount of recorded video

## 3、 Set Up

### 3.1 Log In

The configuration of DVR can be customized by adjusting the menu setting. Press the MENU button and password to enter setup menu. Password verification screen displays as bellow.



The default password is "11111". After entering menu list, use UP/Down and ENTER button on front panel or remote controller to change the settings.

### 3.2 Camera Setting

The DVR allows separate camera setting for each channel, in this function, users adjust the video performance and video loss setting as well. Use UP/DOWN button to move the cursor to select item and use ENTER button to change the setting value.

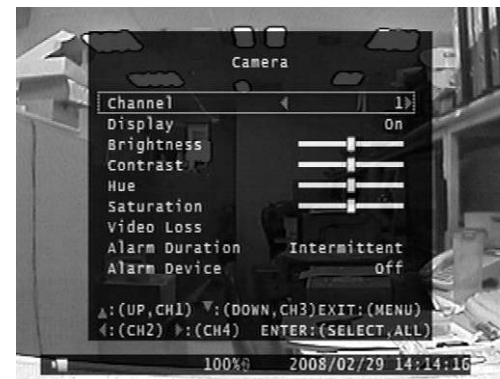

**Channel:** Select the channel which would be adjusted

**Display:** Choose to display the video on screen, or hide the video image as Off

**Brightness/Contrast/Hue/Saturation:** To adjust the image performance by setting brightness, contrast, hue and saturation adjustment.

**Video Loss:** Set the Video Loss Alarm as Intermittent or Continues; alarmed by Buzzer, Alarm Device, Both or Off.

### 3.3 Record Setting

In this item allows users to set record resolution, record speed, record quality, record schedule and other recording parameters.



**Resolution:** The DVR offers two setting option in resolution as 320x224 and 640x224 in 16CH

**Record Speed:** The record speed could be changed for each channel with frame rate. The higher the record rate, the more natural while playback. In this field, use LEFT button to decrease record frame rate, and user RIGHT button to increase record frame rate for each channel. If the record speed was set to be Off, there will be no recording action on the channel.

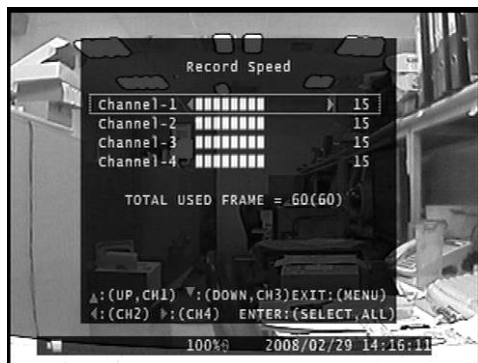

**Record Quality:** Select the record quality as High, Normal or Low.

**Event Rec Duration:** Set the record duration from alarm was triggered in 5, 10, 15, 20, 25, 30 seconds.

**Record Schedule:** The Record Schedule is to set the scheduling record, the numbers indicate the hour of a day from 00:00(12:00am) to 24:00(12:00pm). Use RIGHT and LEFT button to move the cursor to indicate hour, and use ENTER button to change the recording mode by color description on screen. Use ALL button, set the whole day schedule at one time.

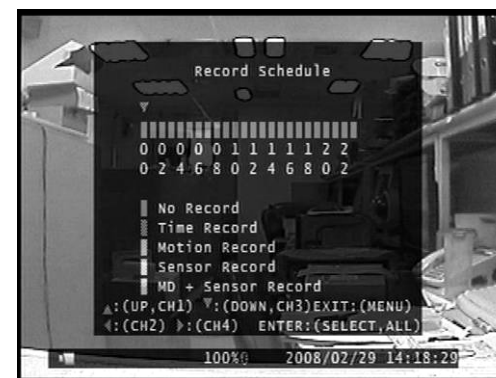

### 3.4 Sensor Setting

The sensor detection will beeped by buzzer on main PCB board or by relay of system, to set buzzer or alarm device for your requirement in following features.

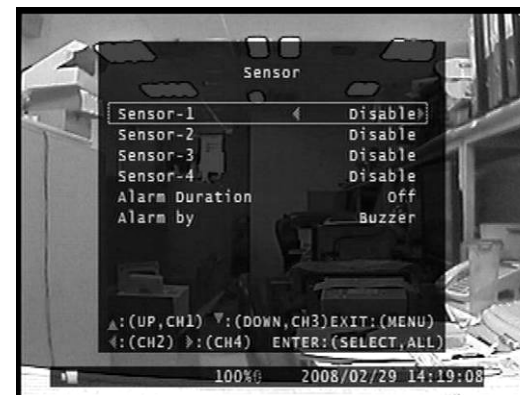

**Sensor Type:** Select DISABLE to deactivate sensor recording or choose the type of sensor as NORMAL-CLOSE or NORMAL-OPEN installed in DVR.

In general, three common sensor types are available in home electronic store: (1) Normal-Close, (2) Normal-Open and (3) Normal-Close & Open. Below is the brief diagram about how each type of sensor is installed on DVR. The procedure for sensor installation is shown as below.

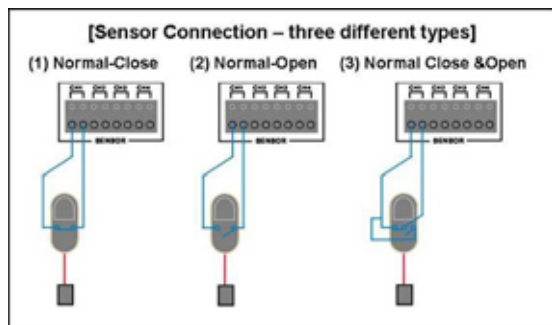

**Alarm Duration:** This item set the alarm duration after alarm is activated as 5, 10, 15, 20, 25, 30 or continue and off.

**Alarm by:** Select alarm by Buzzer, Alarm Device or Both

### 3.5 Motion Detection Setting

In this function, by setting motion area, sensitivity and alarm on each channel, the DVR will start to record on motion detection schedule according to the setting value.

**Channel:** Select the channel for recording mode.

**Sensitivity:** Adjust sensitivity of the built-in motion sensor, the most sensitive goes to 1, and the least goes to 4.

**Motion Area:** Use this option to set the range of motion detection area. Move the cursor to starting area, press ENTER button in order to start selecting. Use UP/DOWN/RIGHT/LEFT button move cursor to draw an area, press ENTER again to set down the selected area.



**Alarm Duration:** Set the alarm duration since alarm was activated in 5~30 seconds or Continue and Off.

**Alarm by:** Select alarm by Buzzer, Alarm Device or Both

### 3.6 Screen Adjustment

In this function, user can adjust the screen setting with screen location, border line or auto sequence.

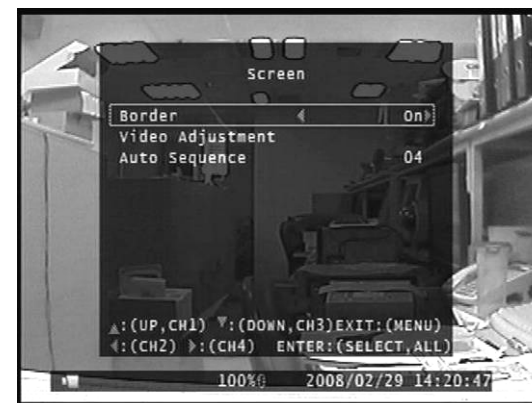

**Border:** Set the white border line around each channel by selecting ON, and close by selecting OFF. **Video Adjustment:** To adjust the horizontal and vertical location of screen by using UP/DOWN/RIGHT/LEFT button.

**Auto Sequence:** To setup the sequence for each channel display on full screen from 2 to 30 seconds.

### 3.7 Audio Setting

Change the recorded audio setting by adjusting setup in this item.

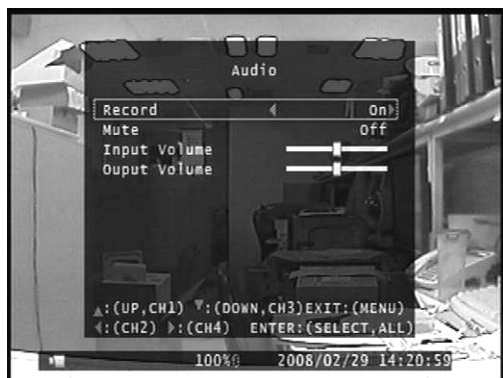

**Record:** Set the record ON to enable audio recording when a microphone device is connected with AUDIO INPUT port on DVR rear panel.

**Mute:** Select ON or OFF. To enable the speaker, choose OFF.

**Input Volume/ Output Volume:** Adjust the input and output volume for speaker and audio recording.

### 3.8 System Setting

#### 3.8.1 Hard Disc Setup



**Overwrite Enable:** Choose “YES” to continue recording and overwrite previous recording data when hard disc drive space is full; choosing “NO”, recording mode will stop when hard disc drive is full of capacity.

**Format HDD:** If the hard disc drive was formatted, all the video data stored will be deleted, the DVR system supports no restore option once the hard disc drive is formatted.

When Format HDD, the password is needed, key in the password and presses any button to continue.



When HDD is successfully formatted, the message below will display.

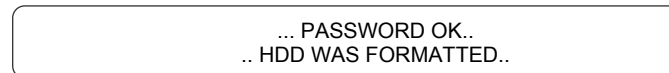

#### 3.8.2 Password Change

Password could be changed for “Menu”, “Record” and “Format HDD” function option.

The default password is “111111”



If the password is forgotten, please contact with your local dealer

### 3.8.3 Time Set

Users can set the current date, time and date format in Time Set menu, the menu displays as follows.

Use UP/DOWN keys to move the cursor to previous or next field, by pressing ENTER button to select, and use UP/DOWN key to change the value in selected field.



**Time Set:** set the current date and time

**Daylight Saving Time:** Choose NO or YES

**Date Format:** DVR offers two formats with YYYY/MM/DD and DD/MM/YYYY

### 3.8.4 Event List

EVENT LIST function allows users to playback video by event. The EVENT LIST will display information contains Power on/off, Record start/stop, Sensor on/off showed with date and time.



To playback by EVENT LIST, using UP/DOWN keys to move the cursor to select the event and press PLAY button to playback.

### 3.8.5 Network Setting

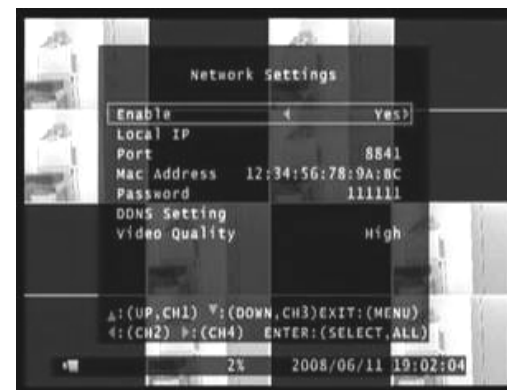

You need to use the network setting information above for real-time network viewing on PC using "Triplex Viewer" software for remote viewing through Ethernet connection.

The Triplex Standalone DVR supports three network connections: STATIC, DHCP for dynamic IP and PPPoE .

**For PPPoE,** Input your id account and password from ISP and save it, restart the DVR, and DVR will auto connect to internet



For **STATIC IP**, input your static IP, gateway, net mask and save it, restart the DVR, and DVR will auto connect to internet



For **DHCP**, Select DHCP and save it, restart the DVR and system will auto allot a IP to use.



### 3.8.6 RS-485

Through RS-485 communication protocol, DVR could control speed dome camera, adjust the RS-485 setting and setup the PTZ camera features in RS-485 and Pan/Tilt Device field of menu.



**Baud rate:** Setup the baud rate of camera from 1200 to 115200

**Data Bit:** Set the data bit 7 or 8

**Parity Bit:** set the parity bit in none, odd or even

**Stop Bit:** set the stop bit in 1 or 2

### 3.8.7 Pan/Tilt/Zoom Device



**Channel:** Select the channel where PTZ camera is connected.





**ID:** Setup the ID of camera

**Model:** Setup the protocol of camera (only support Protocol D and Li Lin)

**Pan/Tilt/Zoom Test:** Using this function to test camera action by DVR keypad or remote controller.

The icon in PTZ camera adjusting mode displays as follow.



 Start PTZ function mode
  Zoom in/ out function
  Focus +/- function
  Iris +/- function

Press ENTER button to change Zoom / Focus / Iris MODE, and using UP and DOWN to change the value, to stop when Zoom in/out, Focus+/- or Iris+/-, press PAUSE button.

### 3.8.8 Firmware Upgrade

This function is for firmware upgrade through USB flash disc. Plug the USB flash disc with new firmware file into USB port, press ENTER button in F/W Upgrade field to update or upgrade the DVR firmware.



### 3.8.9 Load Active-X Control

Load "Active-X Control" Driver from IE browse or CD to remote surveillance control on PC, IE security settings should be set to the default levels to allow the download of the control.

 **Note:** Firewalls or security programs/ devices may prevent downloading the Active-X control.

### 3.9 Video Search

In video search, user could playback the recorded video data by choosing date& time, use the SELECT button to adjust starting and ending date& time for playback. After time period was set, move the cursor to SEARCH and press ENTER button again to start playback from the date& time indicate by user.



### 3.10 Language Selection

The DVR supports multi-language OSD, press ENTER button to choose the language for menu display.

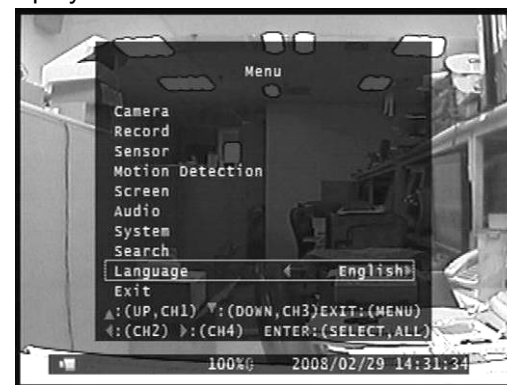

### 3.11 Save System Setup

After the DVR setting adjustment is finish, it required to confirm the changes under EXIT menu.



**Exit & Save Change:** Save for the system change and exit the menu.

**Exit & Discard Change:** Not save the system change and exit the menu.

**Load Setup Default:** back the system setting to default.

### 4、 Playback

To playback, press PLAY button. A Time Search function will display on screen, please refer to the 「Video Search」 part for more information.



### 5、 Back Up

The DVR supports easy video backup via USB flash disc or internal CD-RW / DVD±RW, please ready your USB flash disc or CD-RW / DVD±RW ready and connect to your DVR.



Set your DVR in playback mode, press MENU button, a function bar will display on the button of screen. User could press SELECT button to copy video data In USB flash disc, or press REC button to copy video data in CD-RW / DVD±RW.

**For USB COPY**, it will take few minutes to write data into flash disc, the number for the size of file will keep increasing until the backup is finish.

**For CDR COPY**, when the backup is finish, CD/ DVD will pop out from the CD-RW/ DVD±RW drive

**Notice:** Triplex Standalone DVR supports all CD disc, DVD+R disc, for DVD+RW disc only the on first writing, and not support for DVD-R and DVD-RW disc.

To view the video image saved in backup devices on personal computer, it need the client software "Triplex Viewer" which provide in software CD.

### Player and Remote Monitoring

Triplex Standalone DVR series comes with a software CD named "Triplex Viewer" for remote monitoring, recording, controlling or video playback on the computer. Two parts of Triplex Viewer will be introduced as DVR Player and DVR Net Viewer in following chapter.



# 1、Triplex Viewer – Player

## 1.1 Main Function Menu

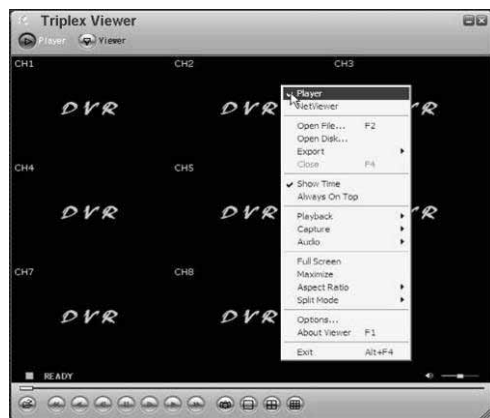

√ <b>Player</b>	To playback video (VVF format) which saved on PC.
<b>Net Viewer</b>	The software will switch to Net Viewer mode for network connection.
<b>Open File</b>	Select the VVF format file to playback
<b>Open Disk</b>	Select disc to read video data of HDD which installed in DVR for recording. (In this function, HDD should be taken out from DVR and connect to PC).
<b>Export</b>	Convert the VVF video format to AVI for standard player like Windows Media Player.
<b>Close</b>	Close Triplex Viewer
<b>Show Time</b>	To display date& time on Triplex viewer screen when playback.
<b>Always On Top</b>	Make the display screen on top.
<b>Playback</b>	Change the setting for playback as reverse playback, fast forward, rewind, speed up/down, or show still video image by single frame
<b>Capture</b>	Click this button in playback mode helps to create a BMP file and save the video image to PC automatically. (the file default saving as C:\VxCapture )
<b>Audio</b>	Make the audio volume up or down or mute.
<b>Full Screen</b>	Make the video image full screen on monitor
<b>Maximize</b>	Maximize the display image as the taskbar still on the button of screen.
<b>Aspect Ratio</b>	Change the display ratio either between 640x480 or 640x554
<b>Split Mode</b>	Choose “Split 1” for full screen display of each channel, choose “split 4” for quad display.
<b>Options</b>	To change the general settings such as DDNS configuration.
<b>About View</b>	Display the information of version.
<b>Exit</b>	Exit Triplex Viewer

## Display Screen



Icon	Indication
	Open and play the saved video file
	Rewind
	Play Reverse
	Go one frame backward and PAUSE
	Pause
	Go one frame forward and PAUSE
	Playback
	Fast Forward
	Adjust volume or enable speaker sound ON/OFF
	View in full screen mode
	View in 4-channel screen mode
	Click this button in playback mode helps to create a BMP file and save the video image to PC automatically. (the file default saving as C:\VxCapture )

## 1.2 Play back with saved video data

After saving the video images on back-up devices, users may want to view the video image on PC. Please follow the instruction below.

- (a) Connect the USB flash disk to your PC or insert the back-up CD into the CD/DVD driver of computer
- (b) Copy both “Triplex Viewer Setup” video image viewer software and the video file with “VVF” file extension name to the local disc drive in your computer.

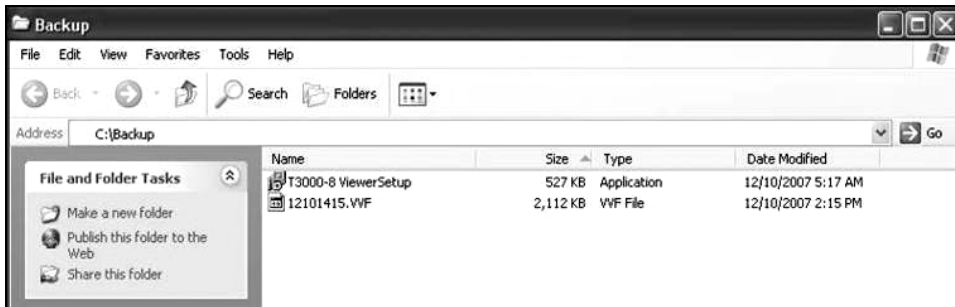

- (c) Double click the “Triplex Viewer Setup” software to run the program. When the viewer screen comes out, use the right click of mouse to show the function menu and choose “Open File”.

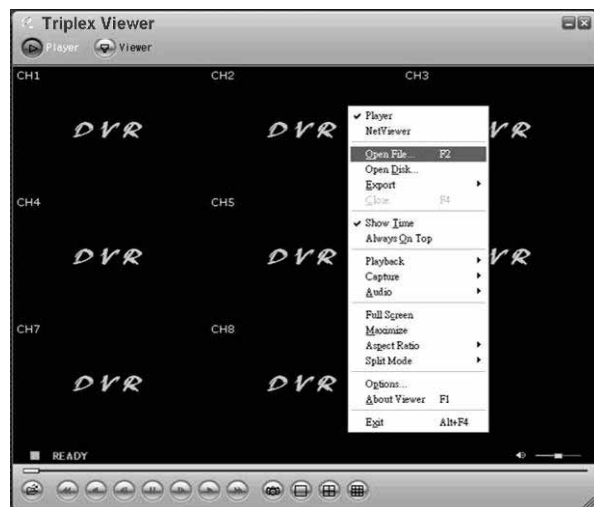

- (d) Select the video image file from USB or CD-RW/ DVD±RW drive which the video file saved.

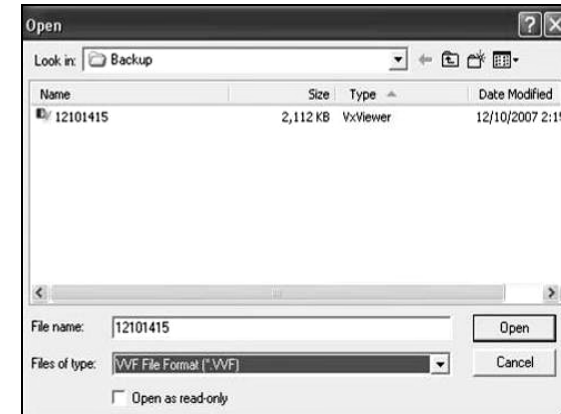

- (e) Open the file and the video image will display by Triplex Viewer..



**Note: For the instant playback, drag and drop the VVF file to Triplex Viewer window.**

### 1.3 Convert Video Format as standard AVI format

Users can convert the backup VVF file into AVI format in order to view by the standard MPEG-4 player or other media player (ex: Windows Media Player).

(1) Choose Export > AVI (Audio-Video Interleaved Files)

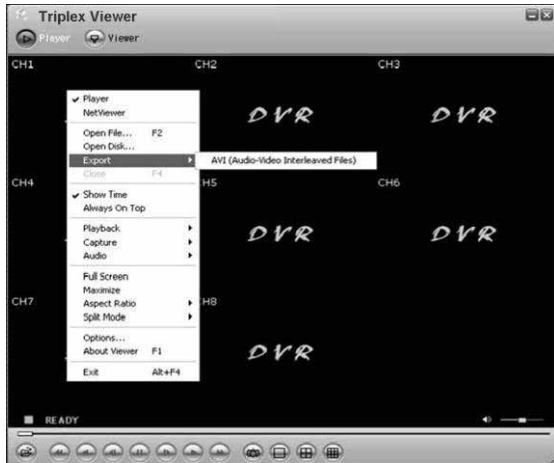

(2) Click "Browse" under "Input File" and select the file which to be converted into AVI format.

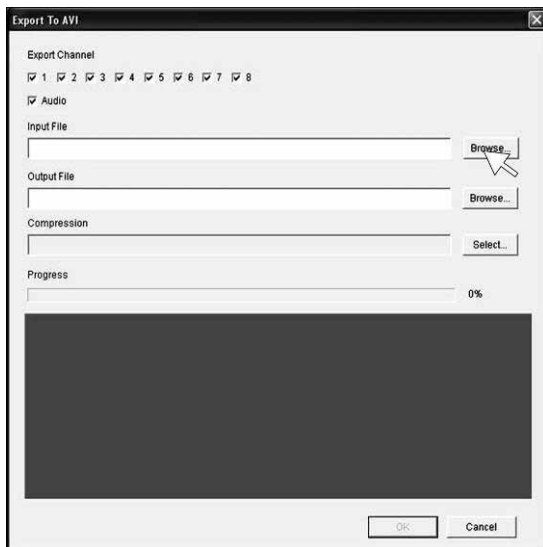

(3) Choose the file which to be converted and click "Open".

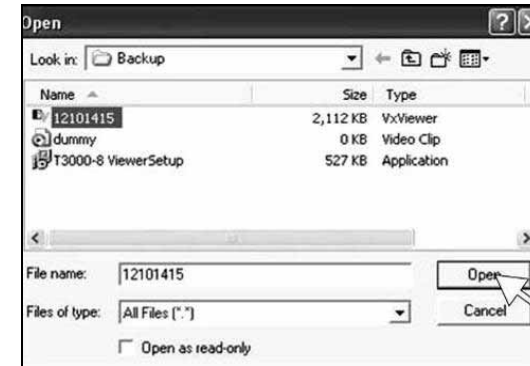

(4) Click "Browse" under Output File and select the directory which to save and name the file. Then click "Select".



(5) Select the type of convert format for compression.

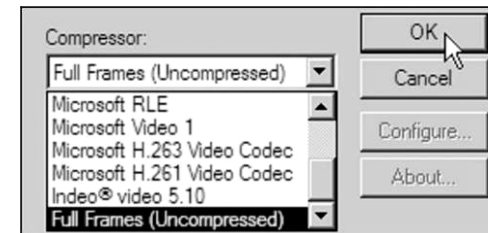

(6) Click "OK" to start convert in few minutes.

(7) Go to the directory where the AVI file saved; open the file with standard media player. (ex: Windows Media Player or GOM Player)

## 2、Triplex Viewer - Net Viewer

Open Triplex Viewer and select “Net Viewer” option for remote monitoring, remote controlling and recording either on PC or DVR.

### 2.1 Main Function Menu



<b>Player</b>	To playback video (VVF format) which saved on PC.
√ <b>Net Viewer</b>	The software will switch to Net Viewer for network connection between PC and DVR.
<b>Connect</b>	Connect the DVR via network either by DHCP or Static IP
<b>DVR Control</b>	Remote control DVR through network
<b>Audio</b>	Adjust the volume up, down or off
<b>Local Recording</b>	It make the video recorded on local PC (the file default saving as C:\VxCapture)
<b>Always On Top</b>	Make the display screen on top.
<b>Full Screen</b>	Make the video image full screen on monitor
<b>Maximize</b>	Maximize the image display while the taskbar still display on the button of screen.
<b>Aspect Ratio</b>	Change the display ratio either between 640x480 or 640x554
<b>Options</b>	To change the general settings such as DDNS configuration.
<b>About View</b>	Display the information of version.
<b>Exit</b>	Exit Triplex Viewer

### 2.2 Connect PC to DVR through local area network (network hub)

(1) In “Net Viewer” mode. Click “Connect” option



(2) Type IP address (the IP address should be the same with DVR) and password (the password is the same as Network setting of DV R menu, default password is 111111), and click “Login”.

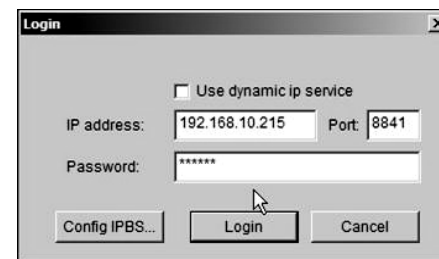

### 2.3 Connect PC to DVR through cross-over cable

- (1) Use the cross-over cable to make connection between DVR and PC. Users might need to change TCP/IP setting under Windows systems. The DVR IP could be set as below (for reference).



- (2) And it needs to change the TCP/IP setting under Windows XP system shown as below.
- (3) Go to TCP/IP setting under Local Area Connection Properties of Windows XP system.

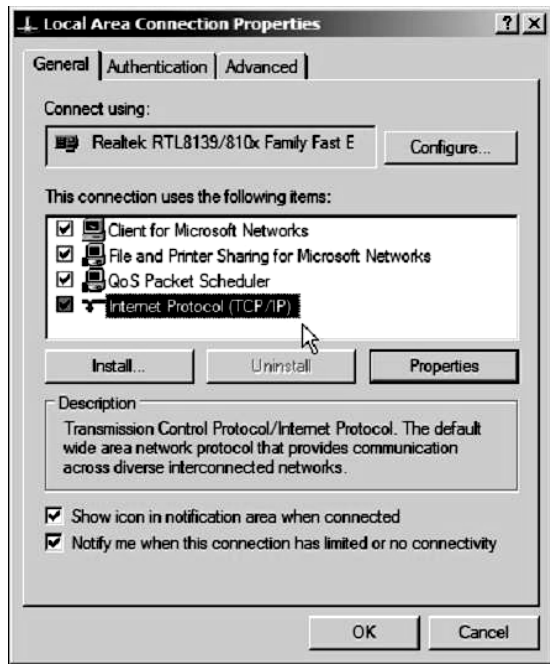

- (4) Key in the address number under IP address / Subnet mask / Default gateway setting according to DVR settings. The IP address should be different with DVR. Subnet mask and Default Gateway setting should be same with DVR setting. Leave the DNS server blank unless it's necessary.



- (5) Click "OK" and run Triplex Viewer, click "Connet" under Net Viewer menu.



(6) Type IP address (same with DVR) and Password (default password is 111111).

 **Note:** Type DVR ID for connection through Dynamic IP service

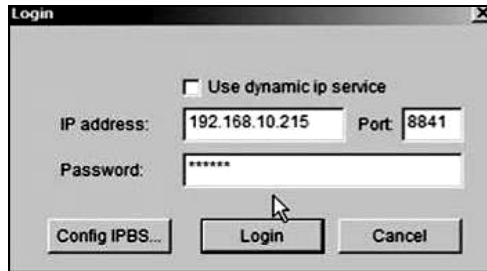

(7) Once the connection starts, the DVR monitor screen will display on PC.



### 3. Remote Monitoring through IE Browser

(1) At first, a Installation of Active-X Control component is needed

(A) Please insert the Triplex DVR CD into CD-ROM, also insert USB flash disc to PC for backup, then copy the file "VXVSETUP.EXE" to USB flash disc from the folder of Active-X Control\ Triplex-4 DVR or Triplex-8 DVR, Triplex-16 DVR..

(B) Connect USB flash disc to DVR, stop any recording mode, and press "Setup" option.

(C) Enter "System / Load Active-X control" of menu.



(D) If the window shows "USB Device does not exist" message means USB flash disc is not connected to DVR well, please try again.



(A) If it comes following message, please press Play button and install "Active-X component" to DVR



(2) Install "VXVSETUP.EXE" to PC

(A) Input DVR IP Address: 192.168.1.100 to URL as <http://192.168.1.100> (reference)



(B) If Triplex Viewer can't show up, Please install [this file](#) to download “VXVSETUP.EXE”

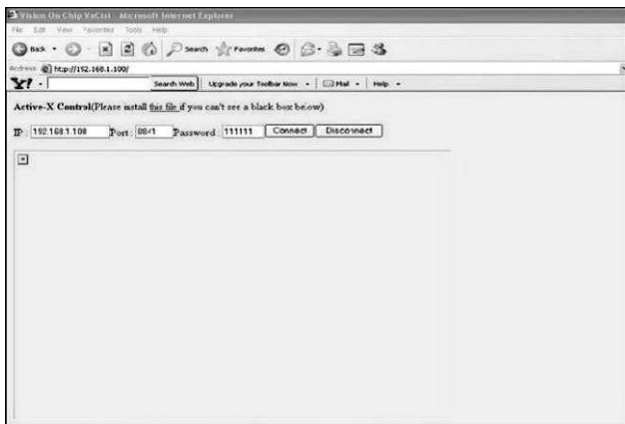

(C) Click [this file](#), and a download message will appear. Please click “Run” to install.



(D) When finished, the shortcut icon and software will pop up the desktop..



(E) After installation, the viewer windows will appear as below, please enter:

IP: 192.168.1.100 (for reference)

DVR port: 8841 (for reference)

Password: 111111 (the default password) then click “Connect”.

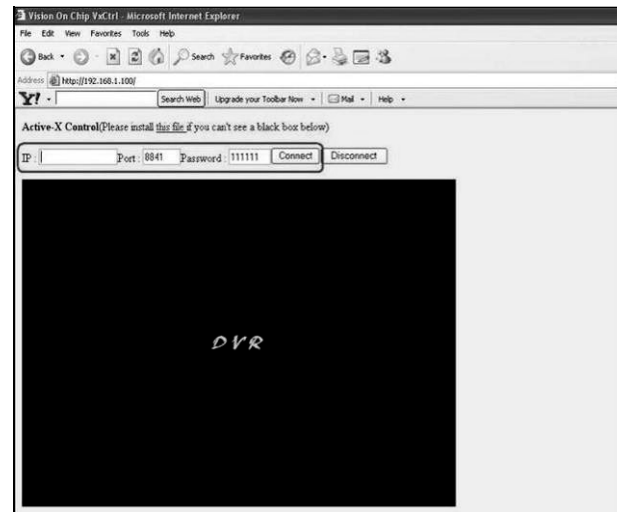

(F) While browsing, user can remote configuring the DVR on IE browser.

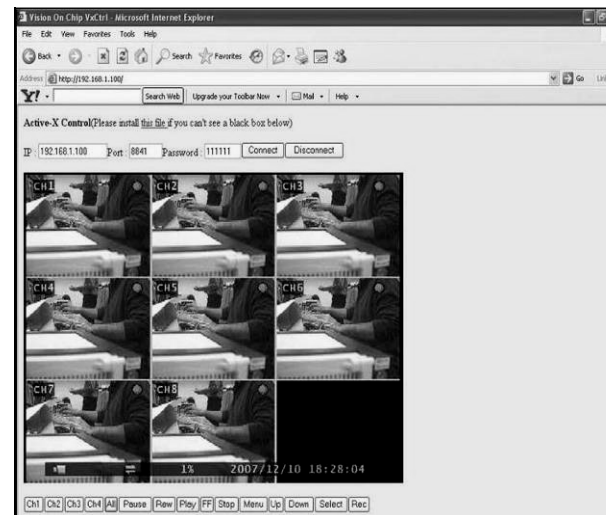

#### 4. DDNS Setup

As the ISP cannot support static IP, we recommended using dynamic IP through DDNS.

##### 4.1 DynDNS Setting

(1) Firstly, apply a new account on DynDNS (DDNS service) website.

(DDNS website: <http://www.dyndns.com>)

(A) Apply a host account with ID & Password.



(B) Select "My hosts" to add host name.

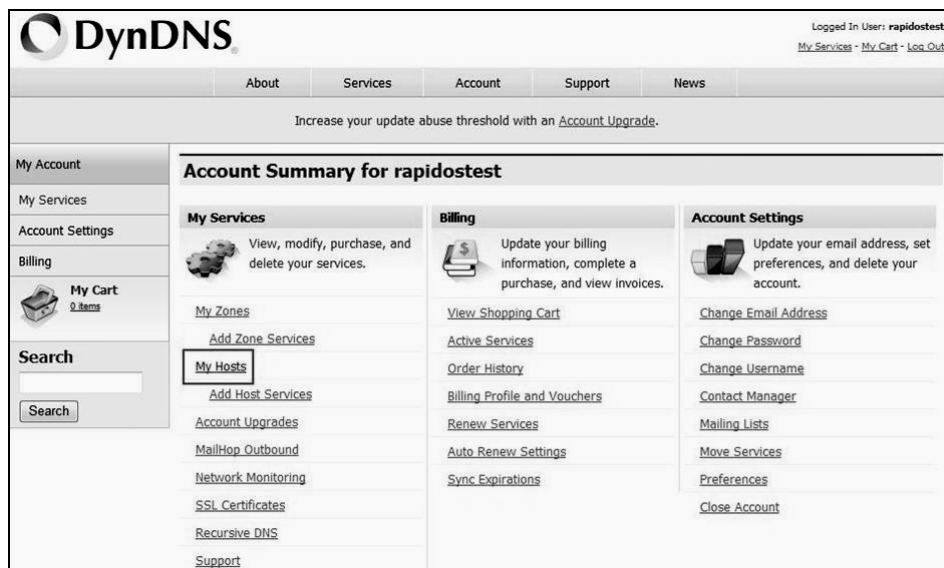

(C) Enter the dynamic IP address detected by DynDNS (DynDNS will auto-detect your dynamic IP address from your ISP) in "IP address". Press the button of "Save Changes" after your confirmation.

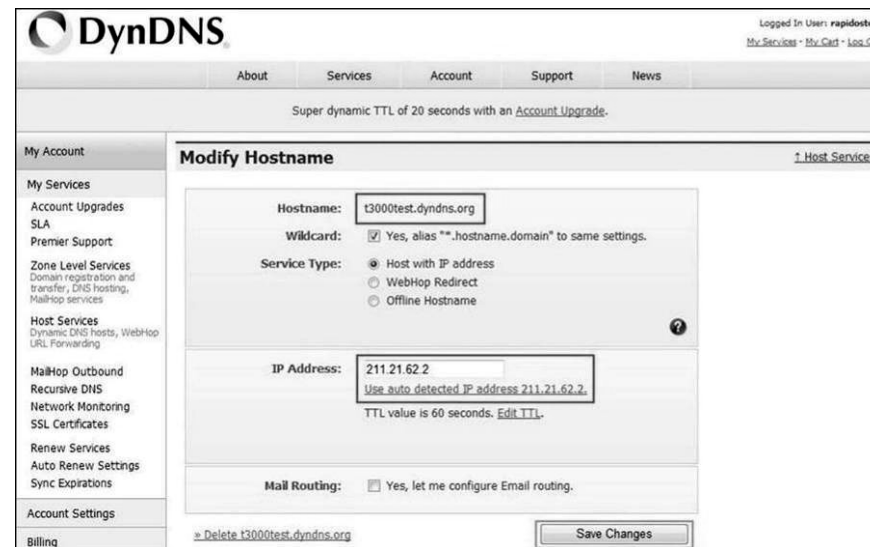

(2) Go to DVR Main Menu → SYSTEM → NETWORK → DDNS Setting to change system setting



Enable: select YES

DNS IP Address: Specify DVR IP as private IP setting

DVR URL: Specify DDNS service provider (domain name)

User ID: Specify DDNS IP by DDNS account (user name)

Password: Specify DDNS IP by DDNS account (password)



## 4.2 Set up 2 DVR under the same router for DDNS

- (1) First of all, connect these 2 DVR to the same router and we can name them as DVR1 & DVR2.
- (2) Change the system setting for DVR1 and DVR2 in DVR main menu:
  - (A) Local IP: a local IP will be shown in DHCP, ex:192.168.1.XXX (this is allocated by router and number will be different)
  - (B) Port: set DVR1 and DVR2 in different port, such as set DVR1 as 8841, set DVR2 as 8842.
  - (C) Mac address: set DVR1 and DVR2 in different Mac address, such as set DVR1 as 12:34:56:78:9A:BC (default), set DVR2 as 12:34:56:78:9A:BD
  - (D) After set up, you may check whether you can see from the DHCP Client List or not. (the layout of the DHCP Client List may be varied to different router, but the function should be more or less the same.)

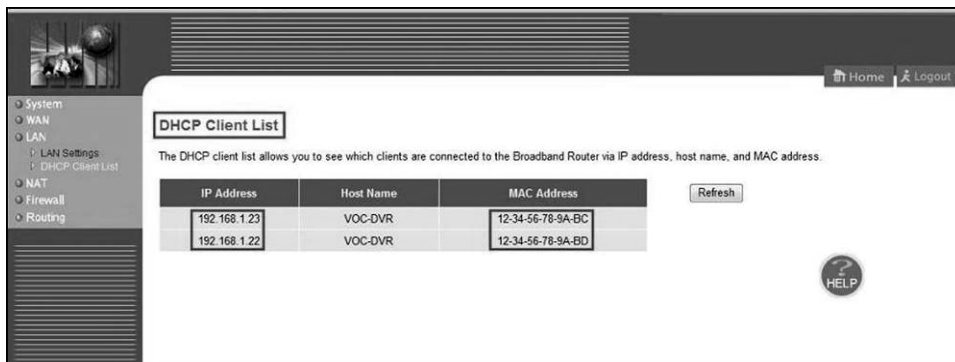

The picture shown as above, 2 DVR IP will be in the list. If the DVR IP address or the IP account are not the same with your setting, please go back to step (2).

- (E) Then, enter the selection of NAT in router to set up the port of DVR1 & DVR2 to a designated IP of DVR in virtual server. The designated IP of the port 80 can choose to key in DVR1 or DVR2. (We recommend using 80 port first. If the 80 port was occupied, change the port setting.)

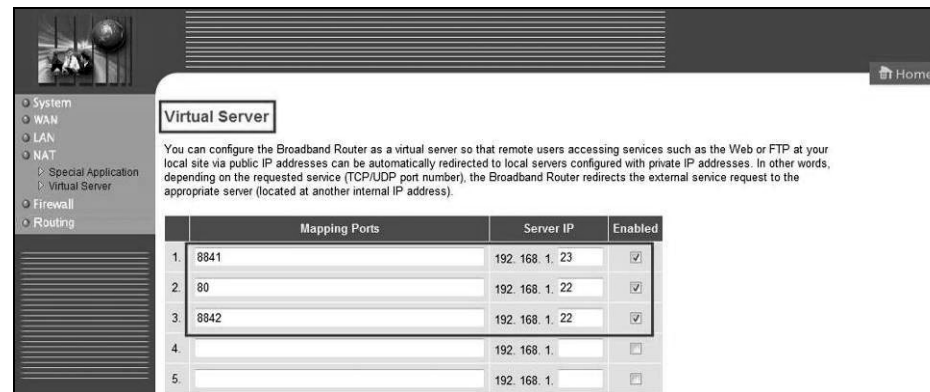

- (F) Afterwards, the set up under router is completed.

- (3) Go to the set up page of DynDNS, please refer to the DDNS Setup chart step(1).

- (A) Make the same setting process for DVR1 and DVR2.

- (4) Go to the DVR main menu: SYSTEM / NETWORK / DDNS setting



Enable: Set to be "Yes"

DNS IP ADDRESS: No need to set

DVR URL: Key in your "Host Name" under DynDNS

USER ID: Key in your "ID" under DynDNS.

Password: Key in your "Password" under DynDNS.

After finishing the setting, you may want test. The following example is for your reference under IE Browser.

The connect screen of DVR1 (8841 port).



The connect screen of DVR2 (8842 port).

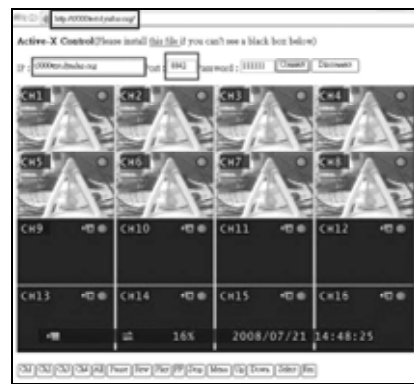

The connect screen by using Client Software.



The connect screen of DVR1 (8841 port).



The connect screen of DVR2 (8842 port).

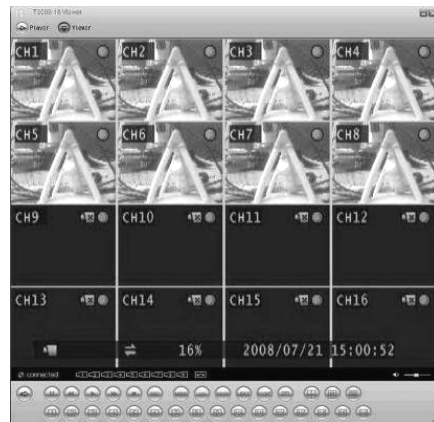
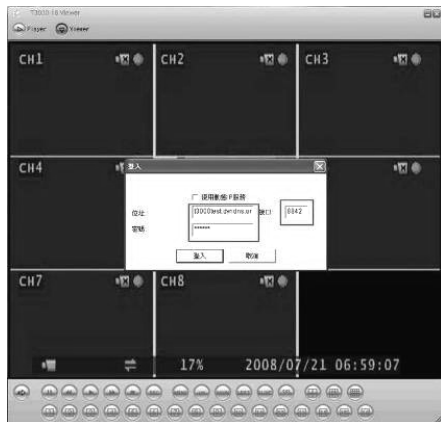

## Appendix A – Recommended HDD

Refer to the following list for some recommended HDD to be used in DVR

Manufacturer	Model Name	Interface	Capacity
Seagate	ST3160812AV	IDE	160G
	ST3250820AV	IDE	250G
	ST3160811AS	SATA	160G
	ST3250410AS	SATA	250G
	ST3500320AS	SATA	500G
	ST3750330AS	SATA	750G
WD	ST31000340AS	SATA	1T
	WD250JB	IDE	250G
HITACHI	WD5000AACS	SATA	500G
	HDS721616PLAT80	IDE	160G
	HDP725050GLA360	SATA	500G
	HDS721075KLA330	SATA	750G

## Appendix B – HDD Record Time Table

Base on recording frame and quality, a reference list for record time table is as following table.

The recording hours is based on **250GB HDD for 4-Channel**

NTSC	Frame Per Second		3	4	5	7	10	15	30	hours
	Quality	High	303	228	182	130	91	61	30	
		Normal	405	303	243	173	121	81	40	
		Low	1214	910	728	520	364	243	121	

PAL	Frame Per Second		3	4	6	8	12	25	hours
	Quality	High	303	228	152	114	76	36	
		Normal	405	303	202	152	101	49	
		Low	1214	910	607	455	303	146	

The recording hours is based on **500GB HDD for 16-Channel**

NTSC	Frame Per Second		3	4	5	7	hours
	Quality	High	152	114	91	65	
		Normal	202	152	121	87	
		Low	607	455	364	260	

PAL	Frame Per Second		3	4	5	6	hours
	Quality	High	152	114	91	76	
		Normal	202	152	121	101	
		Low	607	455	364	303	

## Appendix C – Camera Installation Guide

1) Check all accessories

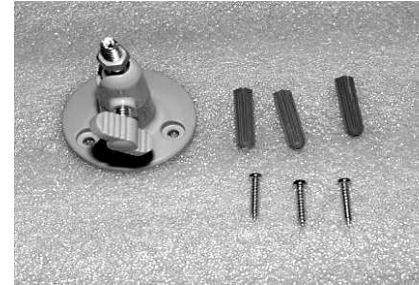

2) Lock Screws with camera stand



3) Lock camera on stand

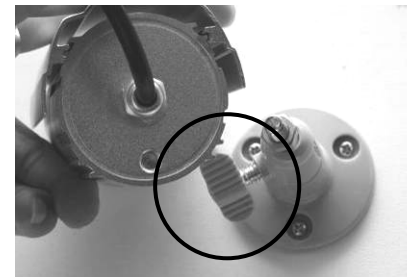

5) Adjust and lock the angle of shooting



6) Connect power lines and video cable



7) Camera video input through BNC

