

Time Lapse Recorder

User's Guide



Be sure to read carefully and follow all the SAFETY INFORMATION on pages i, ii, iii.

Keep the manual in a safe place for future reference.

Precautions

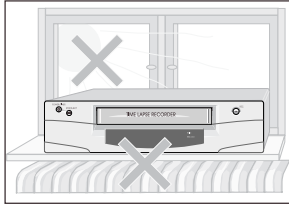

- Read carefully through this manual to familiarize yourself with this high-quality Time Lapse VCR.
- Make sure the rating of your household electricity supply matches that shown on the back of the Time Lapse VCR.
- During the power off, the unit is always connected to the mains. Unplug the unit from the wall outlet if it is not to be used for several days or more.

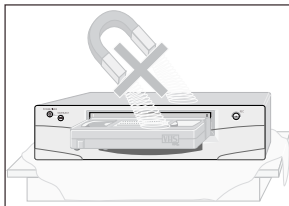

Do not ...

- ... expose the Time Lapse VCR to high levels of humidity and heat, to avoid the risk of fire and electric shock.
- ... open the Time Lapse VCR. Have a qualified technician carry out repairs.
- ... connect the Time Lapse VCR to the power supply if you have just moved it from a cold to warm environment. This can result in condensation inside the recorder and cause serious damage to the machine and cassettes. Wait around two hours to allow it to reach room temperature.

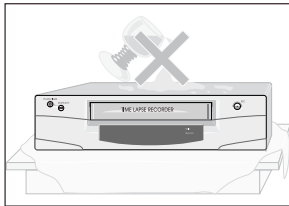

Make sure ...

- ... the Time Lapse VCR is placed on a steady, flat surface.
- ... you place the Time Lapse VCR where there is good ventilation all around.
- ... you clean the Time Lapse VCR only with a soft, lint-free cloth; do not use aggressive or alcohol-based cleaning agents.
- ... you disconnect the power supply if the Time Lapse VCR appears to be working incorrectly, is making an unusual sound, has a strange smell, has smoke emitting from it or liquids have got inside it. Have a qualified technician check the recorder.
- ... you disconnect the power supply and aerial if you will not be using the Time Lapse VCR for a long period or during a thunderstorm.

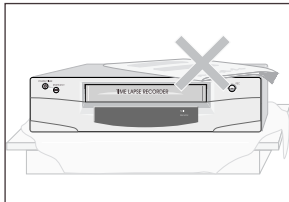

For your own safety!



- There are no components in this Time Lapse VCR you can service or repair yourself.
- Do not open the case of the Time Lapse VCR. Only allow qualified personnel to repair or service your set.



- This Time Lapse VCR is designed for continuous operation. Switching it off does not disconnect it from the mains (stand-by). To disconnect it from the mains, you have to unplug it.
- Recording any copyright protected material may infringe a copyright.

Important Safeguards

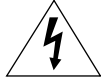
CAUTION RISK OF ELECTRIC SHOCK DO NOT OPEN	
CAUTION: TO REDUCE THE RISK OF ELECTRIC SHOCK, DO NOT REMOVE COVER (OR BACK). NO USER-SERVICEABLE PARTS INSIDE. REFER SERVICING TO QUALIFIED SERVICE PERSONNEL.	



The lightning flash with arrowhead symbol, within an equilateral triangle, is intended to alert the user to the presence of uninsulated "dangerous voltage" within the product's enclosure that may be of sufficient magnitude to constitute a risk of electric shock.



The exclamation point within an equilateral triangle is intended to alert the user to the presence of important operating and servicing instructions in the literature accompanying the appliance.

WARNING : TO REDUCE THE RISK OF FIRE OR ELECTRIC SHOCK, DO NOT EXPOSE THIS APPLIANCE TO RAIN OR MOISTURE.

CAUTION : TO PREVENT ELECTRIC SHOCK, MATCH WIDE BLADE OF PLUG TO WIDE SLOT, FULLY INSERT.

1. **READ INSTRUCTIONS** - All the safety and operating instructions should be read before the unit is operated.
2. **RETAIN INSTRUCTIONS** - The safety and operating instructions should be retained for future reference.
3. **HEED WARNINGS** - All warnings on the unit and in the operating instructions should be adhered to.
4. **FOLLOW INSTRUCTIONS** - All operating and use instructions should be followed.
5. **CLEANING** - Unplug this unit from the wall outlet before cleaning. Do not use liquid cleaners or aerosol cleaners. Use a damp cloth for cleaning.
6. **ATTACHMENTS** - Do not use attachments not recommended by the unit's manufacturer as they may cause hazards.
7. **WATER AND MOISTURE** - Do not use this unit near water - for example, near a bathtub, washbowl, kitchen sink or laundry tub; in a wet basement; nor near a swimming pool in an unprotected outdoor installation, or any area which is classified as a wet location.
8. **ACCESSORIES** - Do not place this unit on an unstable stand, tripod, bracket or mount. The unit may fall, causing serious injury to a person and serious damage to the unit. Use only with a stand, tripod, bracket nor mount recommended by the manufacturer or sold with the unit. Any mounting of the unit should follow the manufacturer's instructions and should use a mounting accessory recommended by the manufacturer. An appliance and cart combination should be moved with care. Quick stops, excessive force, and uneven surfaces may cause the appliance and cart combination to overturn.
 
9. **VENTILATION** - Openings in the enclosure, if any, are provided for ventilation and to ensure reliable operation of the unit and to protect it from overheating. These openings must not be blocked or covered. This unit should never be placed in a built-in installation unless proper ventilation is provided or the manufacturer's instructions have been adhered to.
10. **POWER SOURCES** - This unit should be operated only from the type of power source indicated on the marking label. If you are not sure of the type of power supply you plan to use, consult your appliance dealer or local power company. For units intended to operate from battery or other sources, refer to the operating instructions.

-
- 11. GROUNDING OR POLARIZATION** - This unit may be equipped with a polarized alternating-current line plug (a plug having one blade wider than the other). This plug will fit into the power outlet only one way. This is a safety feature. If you are unable to insert the plug fully into the outlet, try reversing the plug. If the plug should still fail to fit, contact your electrician to replace your obsolete outlet. Do not defeat the safety purpose of the polarized plug. Alternately, this unit may be equipped with a 3-wire grounding-type plug, having a third (grounding) pin. This plug will only fit into a grounding-type power outlet. This is a safety feature. If you are unable to insert the plug into the outlet, contact your electrician to replace your obsolete outlet. Do not defeat the safety purpose of the grounding-type plug.
 - 12. POWER-CORD PROTECTION** - Power-supply cords should be routed so that they are not likely to be walked on or pinched by items placed upon or against them, paying particular attention to cords and plugs, convenience receptacles, and the point where they exit from the appliance.
 - 13. POWER LINES** - An outdoor system should not be located in the vicinity of overhead power lines or other electric light or power circuits, or where it can fall into such power lines or circuits. When installing an outdoor system, extreme care should be taken to keep from touching such power lines or circuits as contact with them might be fatal. U.S.A models only - refer to the National Electrical Code Article 820 regarding installation of CATV systems.
 - 14. OVERLOADING** - Do not overload outlets and extension cords as this can result in a risk of fire or electric shock.
 - 15. OBJECT AND LIQUID ENTRY** - Do not push objects of any kind into this unit through openings as they may touch dangerous voltage points or short-out parts that could result in a fire or electric shock. Never spill liquid of any kind on the unit.
 - 16. SERVICING** - Do not attempt to service this unit yourself as opening or removing covers may expose you to dangerous voltage or other hazards. Refer all servicing to qualified service personnel.
 - 17. DAMAGE REQUIRING SERVICE** - Unplug the unit from the wall outlet and refer servicing to qualified service personnel under the following conditions:
 - a. When the power-supply cord or plug is damaged.
 - b. If liquid has been spilled, or objects have fallen into the unit.
 - c. If the unit has been exposed to rain or water.
 - d. If the unit does not operate normally by following the operating instructions. Adjust only those controls that are covered by the operating instructions, as an adjustment of other controls may result in damage and will often require extensive work by a qualified technician to restore the unit to its normal operation.
 - e. If the unit has been dropped or the cabinet has been damaged.
 - f. When the unit exhibits a distinct change in performance - this indicates a need for service.
 - 18. REPLACEMENT PARTS** - When replacement parts are required, be sure the service technician uses replacement parts specified by the manufacturer or have the same characteristics as the original part. Unauthorized substitutions may result in fire, electric shock or other hazards.
 - 19. SAFETY CHECK** - Upon completion of any service or repairs to this unit, ask the service technician to perform safety checks to determine that the unit is in proper operating condition.
 - 20. COAX GROUNDING** - If an outside cable system is connected to the unit, be sure the cable system is grounded. U.S.A models only - Section 810 of the National Electric Code, ANSI/NFPA No.70-1981, provides information with respect to proper grounding of the mount and supporting structure, grounding of the coax to a discharge unit, size of grounding conductors, location of discharge unit, connection to grounding electrodes and requirements for the grounding electrode.
 - 21. LIGHTNING** - For added protection of this unit during a lightning storm or when it is left unattended and unused for long period of time, unplug power cord from the wall.

Polarized Attachment Plug Marking - for CNL use only.

CAUTION - TO PREVENT ELECTRIC SHOCK, MATCH WIDE BLADE OF PLUG TO WIDE SLOT, FULLY INSERT

Contents

Locations of controls and indicators	1
Front panel	1
Digital display	2
Display of operating conditions	3
Back panel.....	4
Remote control.....	5
Connections	6
Video Cassettes Tapes	7
Types of on-screen displays and Display Sequence	8
Setting the Clock	10
Changing the on-screen display	12
Normal Recording	14
Program Timer Recording	15
Alarm Recording	19
Panic Recording	20
Series(Link) Recording	20
Autorepeat Recording	22
Normal Playback	23
Normal Playback	23
Tracking Control	23
Audio Playback	23
Special Playback	24
Picture Search	24
Still Image	24
Vertical Lock Control	24
Slow	24
Recording Check	24
Time/Date Search	25
Alarm Search	25
Alarm Scan	26
Zero Search.....	26
Other functions	27
Tape Counter (Zero Search)	27
Setting the Security Lock (Set Lock)	28
Setting the SW Out Terminal Output	28
Setting the Buzzer	29
Changing the Alarm Recording Times	30
Checking the Power Loss Times	30
Checking Usage Duration	31
Setting In/Out Terminals	31
Maintenance	34
Troubleshooting Guide	35
Specifications	37

Locations of controls and indicators

Front panel

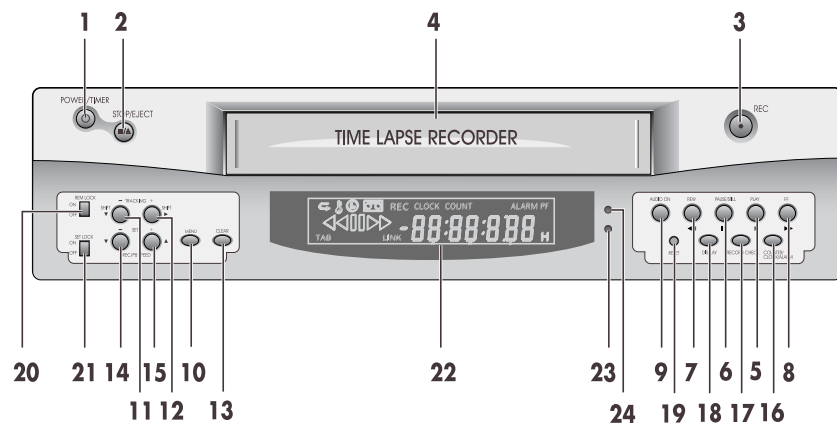

- | | | | |
|----|--|----|--|
| 1 | POWER/TIMER button | 15 | REC/PLAY SPEED(▲) button
(SET + button) |
| 2 | STOP/EJECT button | 16 | COUNTER/CLOCK/ALARM
button |
| 3 | RECORD button | 17 | RECORD CHECK button |
| 4 | CASSETTE Compartment | 18 | DISPLAY button |
| 5 | PLAY button | 19 | RESET button |
| 6 | PAUSE/STILL button | 20 | Remote Control LOCK switch |
| 7 | REW button | 21 | SET LOCK switch |
| 8 | FF button | 22 | Display Window |
| 9 | AUDIO ON button | 23 | Remote Control LOCK
indicator
It comes on when the Remote
Control Lock switch is set to the
"ON" position. |
| 10 | MENU button | 24 | PANIC IN indicator |
| 11 | SHIFT(▼) / TRACKING (-)
button | | |
| 12 | SHIFT(▶) / TRACKING (+)
button | | |
| 13 | CLEAR button | | |
| 14 | REC/PLAY SPEED(▼) button
(SET - button) | | |

Digital Display

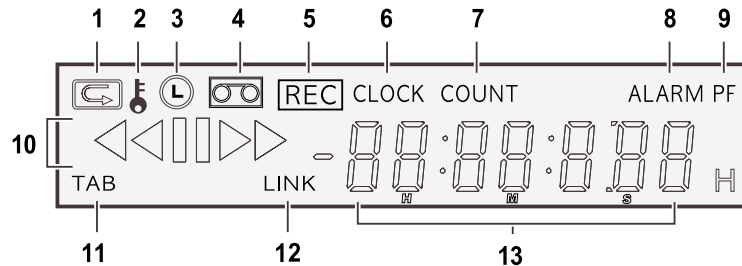

1 Repeat recording

It indicates that repeat recording is activated. When the tape reaches its end, the unit will rewind and record over previously taped footage.

2 SET LOCK

It comes on when the SET LOCK sw is set to the "ON" position.

3 Timer recording

It appears when the timer is programmed.

4 Cassette status indicator

It illuminates when a tape is inserted.

5 REC indicator

It illuminates during recording and when TIMER REC is set to on.

6 CLOCK indicator

It indicates the current time.

7 COUNT indicator

It indicates the relative position on the tape.

8 ALARM indicator

It appears after the alarm mode is activated.

9 PF indicator

It indicates the existence of power failure.

10 Play / cue / review / still / slow

It indicates the tape operation.

11 TAB indicator

It appears when the tape does not have a security tab.

12 LINK indicator

It appears when LINK (Series) REC is turned on.

13 Digit indicator

It indicates clock, tape counter, and tape speed during playback/recording.

14 Mode display

- TAPE COUNTER display (ex: 10:HOUR, 59:MINUTE)
- Maximum Hour : 19 - Maximum Minute : 59

- ALARM COUNTER display (ex: A:Alarm , 32:Alarm No.)

- PLAY/REC SPEED display (ex: 36H:Play/Recording Speed)

- TIME display (ex: 7:HOUR , 07:MINUTE)

- ERROR display (ex: E:Error , 04:Error No.)
 - E-01 : The cassette cannot be loaded or unloaded.
 - E-02 : The tape stops.
 - E-03 : The drum can not rotate properly.
 - E-04 : The tape is cut/broken.

- AUDIO ON display (ex: A:Audio , 18H:Play Speed)

Display of operating conditions

	Operation Mode	Indicator
1	Record(REC)	▶ REC
2	Record pause (REC PAUSE)	REC
3	Playback (PLAY)	▶
4	Still image (STILL)	
5	Fast forward (FF)	▶▶
6	Rewind (REW)	◀◀
7	CUE (CUE)	▶▶▶
8	Review (REVIEW)	◀◀◀
9	Slow (Pause Still + FF, Pause Still + REW)	▶▶

Back Panel

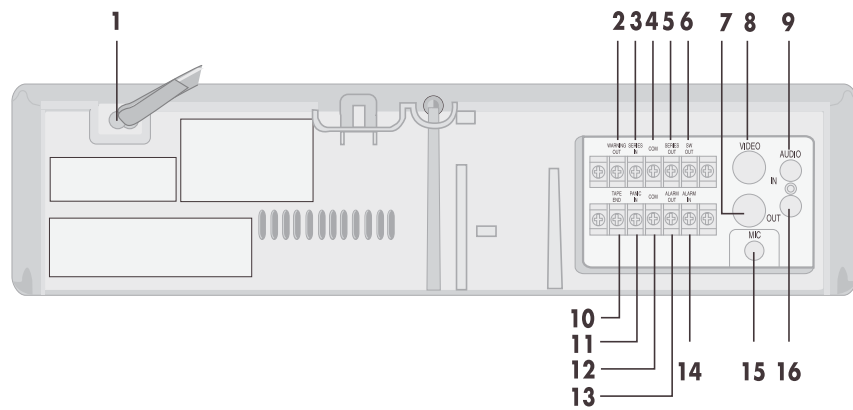

- 1 AC POWER CORD
- 2 WARNING OUT terminal
- 3 SERIES IN terminal
- 4 COM terminal
- 5 SERIES OUT terminal
- 6 SW OUT terminal
- 7 VIDEO OUT jack (BNC Type)
- 8 VIDEO IN jack (BNC Type)
- 9 AUDIO IN jack (RCA Type)
- 10 TAPE END terminal
- 11 PANIC IN terminal
- 12 COM terminal
- 13 ALARM OUT terminal
- 14 ALARM IN terminal
- 15 MIC(microphone input) jack
- 16 AUDIO OUT jack (RCA Type)

Remote Control

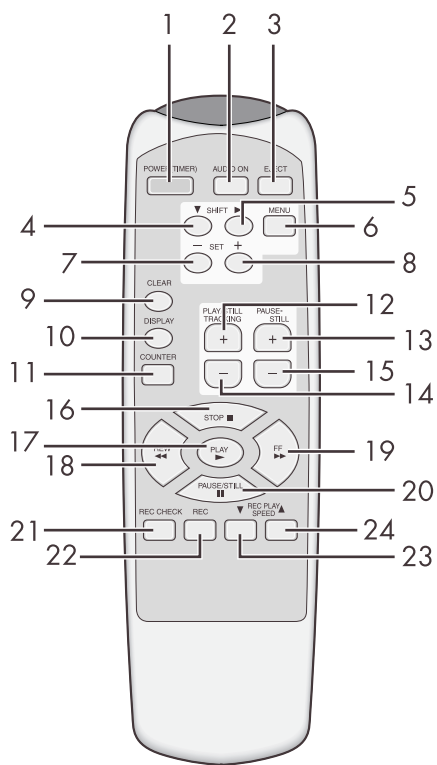

(Optional)

- 1 POWER (TIMER) button
- 2 AUDIO ON button
- 3 EJECT button
- 4 SHIFT ▼ button
- 5 SHIFT ► button
- 6 MENU button
- 7 SET - button
- 8 SET + button
- 9 CLEAR button
- 10 DISPLAY button
- 11 COUNTER button
- 12 PLAY/STILL TRACKING + button
- 13 PAUSE / STILL + button
- 14 PLAY/STILL TRACKING - button
- 15 PAUSE/STILL - button
- 16 STOP ■ button
- 17 PLAY ► button
- 18 REW ◀◀ button
- 19 FF ►► button
- 20 PAUSE / STILL button
- 21 REC CHECK button
- 22 REC button
- 23 REC/PLAY SPEED ▼ button
- 24 REC/PLAY SPEED ▲ button

Connections

Connect the video camera and monitor TV as shown in the figure below.

NOTE : Make sure to turn the power off on all devices before making the connections.

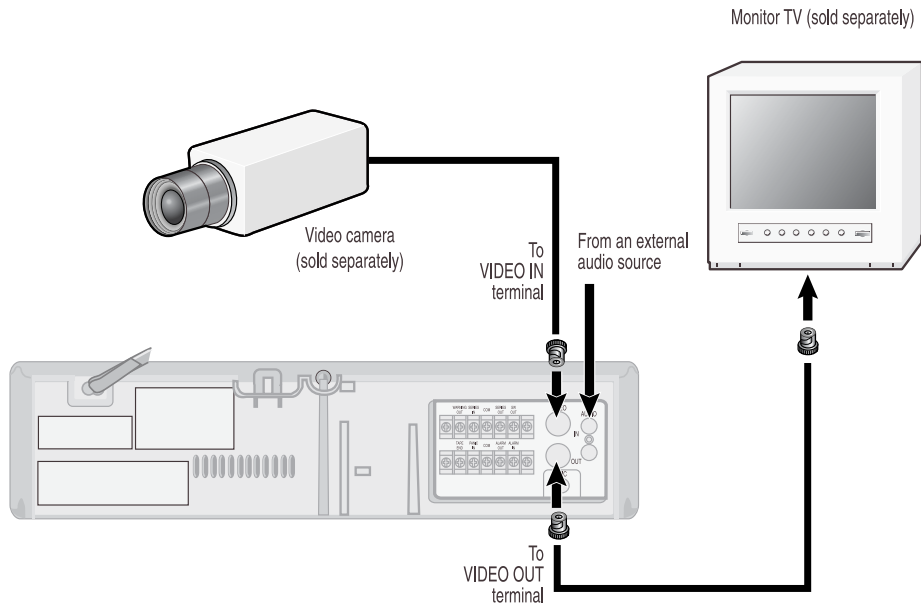

Power Cord Installation

Insert the plug of the power cord into an outlet.



- For more details, please refer to the manuals accompanying all other devices. If the connections are not made properly, it may cause a fire or damage the equipment.

Video Cassettes Tapes



- If you try to record on a cassette without the erasure-prevention tab, the VCR will eject the cassette.
- If the **TIMER** button is pressed when a cassette without the erasure-prevention tab is loaded, the VCR will eject the cassette, the timer recording indicator (⊖) will start flashing and a buzzer will sound if "YES" is set in the menu for buzzer.



- When the cassette is loaded, the cassette indicator "CC" will light on the display panel.
- The counter display will switch to the reset counter "OH OOM OOS" display on the monitor screen. ("OH OOM OOS" on the display panel.)



- Do not insert any object in the cassette loading slot, as that may cause injury and damage to the VCR.
- If your hand gets stuck in the cassette loading slot, unplug the power cord and consult the dealer where the unit was bought. Do not forcibly pull the hand out as that may cause severe injuries.

Use only video cassette tapes bearing the **VHS** logo.

This VCR was primarily designed for use with T-120 cassette tapes. It is recommended to use T-120 VHS video cassette tapes for optimal performance.

Handling Cassette Tapes

Cassette tapes should always be stored vertically in their cases, away from high temperatures, magnetic fields, direct sunlight, dirt, dust and locations subject to mold formation.

Do not tamper with the cassette mechanism.

Never touch the tape with your fingers.

Protect cassette tapes from shocks or strong vibrations.

To Protect your recordings

After having recorded a tape, if you wish to keep the recording, use a flathead screwdriver to break off the erasure-prevention tab on the cassette.

To record again on a tape without erasure-prevention tab, cover the hole with adhesive tape.

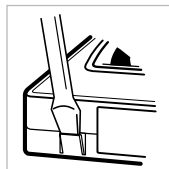

Erasure-prevention tab

To prevent accidental erasure, remove the tab after recording.

To record again, cover the hole with vinyl tape.

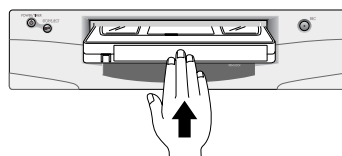

Loading

Place the cassette, label side up, in the loading slot. Gently push the center of the cassette until it is loaded automatically.

Unloading

In **STOP** mode, press the **EJECT** button. The cassette is automatically ejected.

Types of on-screen displays and Display Sequence

- If the VCR is in timer recording stand-by mode (the "⊙" indicator is displayed on the display panel), the on-screen displays will not be available. First press the Power/Timer button, to cancel the recording stand-by mode, then proceed with the VCR programming. When finished, press the Power/Timer button again to return the VCR to timer recording stand-by mode.
- When a menu is displayed, recording will not be possible.
- Press the MENU button three times, the setting procedure is now completed then the normal screen is displayed.
- During recording or playback the menus cannot be displayed.

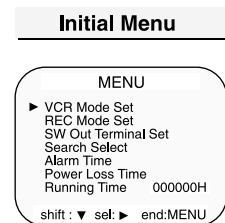

- Press the MENU button. (First time)
- Press the SHIFT ▼ button to move the arrow mark (▶) downward for the desired item.
- Press the SHIFT ▶ button to select the desired item, then the desired menu is displayed.
- Press the MENU button to return to the normal screen from the initial menu.

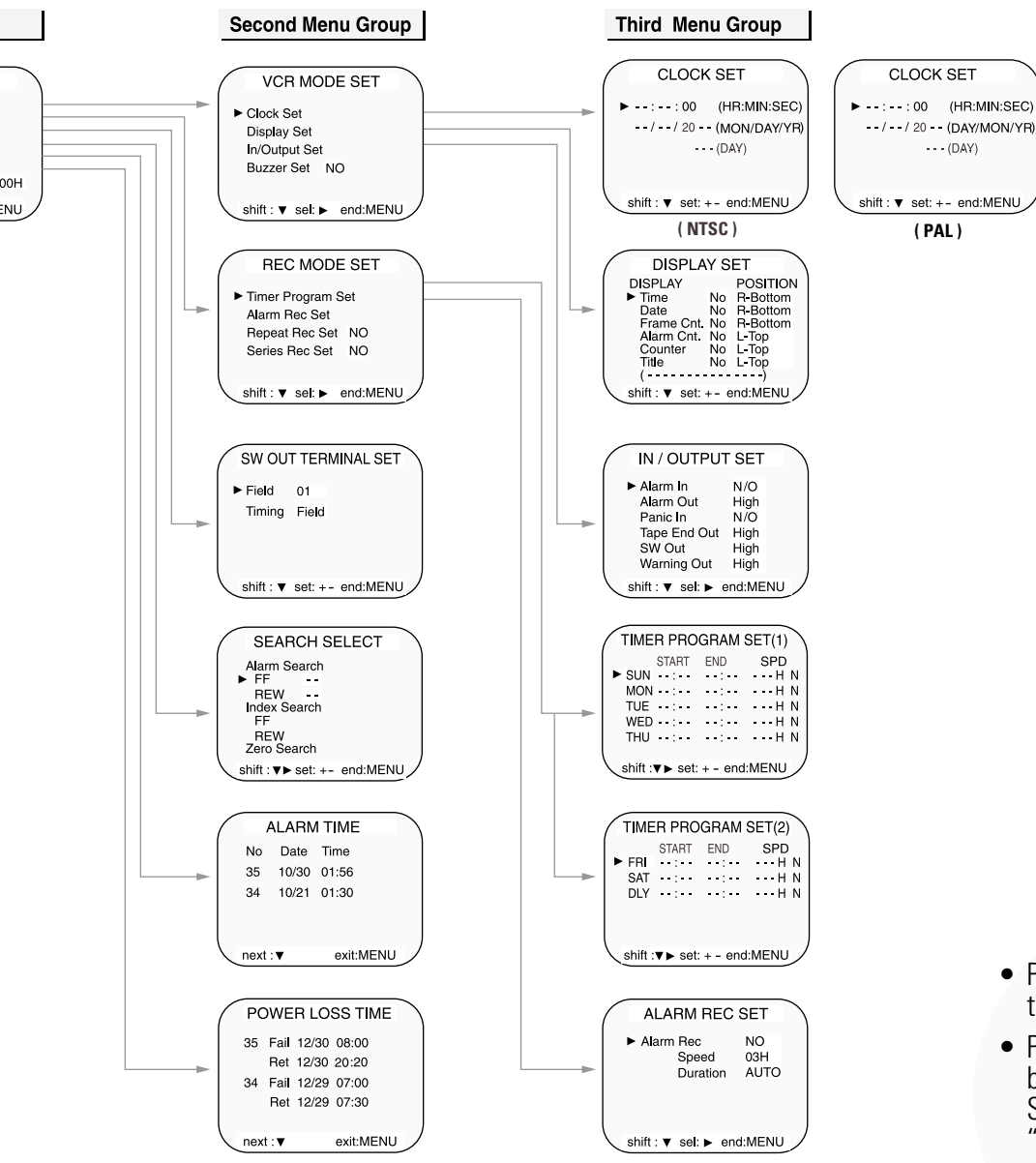

- Press the SHIFT ▶ button to select the desired item.
- Press the SET - (or +) button to set or Press the SHIFT ▶ button to select "YES" or "NO".
- Press the MENU button to return to the initial menu.

Setting the Clock

Example: To set the clock to April 12, 2000 at 9:30

Clock Setting

- 1 Turn the power on to all devices used.
- 2 Press the MENU button, the initial menu is displayed. Press the SHIFT ▼ button to move the arrow mark (▶) located on "VCR Mode Set".

Initial MENU

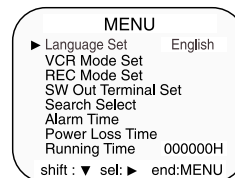

- 3 Press the SHIFT ▶ button, the VCR MODE SET menu is displayed. The arrow mark (▶) is located in "Clock Set".

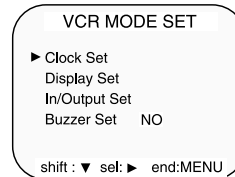

- 4 Press the SHIFT ▶ button, the CLOCK SET menu is displayed.

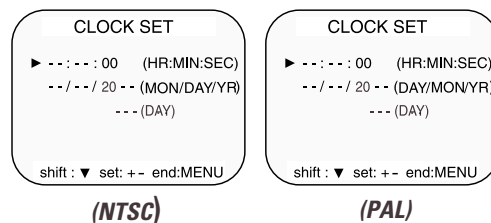

- 5 Press the SET - (or +) button to set the hours (ex : 09), then press the SHIFT ▶ button.

-
- 6 Press the SET - (or +) button to set the minutes (ex : 30), then press the SHIFT ► button.
 - 7 The seconds are already set to "00".
 - 8 Press the SHIFT ► button.
 - 9 Press the SET - (or +) button to set the month (ex : 04), then press the SHIFT ► button.**(NTSC)**
Press the SET - (or +) button to set the day (ex : 12), then press the SHIFT ► button.**(PAL)**
 - 10 Press the SET - (or +) button to set the day (ex : 12), then press the SHIFT ► button.**(NTSC)**
Press the SET - (or +) button to set the day month (ex : 04), then press the SHIFT ► button.**(PAL)**
 - 11 Press the SET - (or +) button to set the year.
 - *The day of the week is set automatically.*
 - 12 Press the MENU button three times, the normal screen is displayed.
 - *The setting procedure is now complete.*

Changing the On-Screen Display

Selecting the Language

You can select the language -English, French, Spanish or German- which is more convenient for you.

- 1 Turn the power on to all devices used.
- 2 Press the MENU button. The initial menu is displayed. The arrow mark (►) is located in "Language Set".

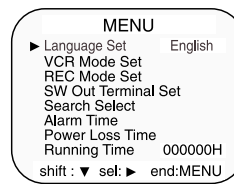

- 3 Press the SHIFT ► button to select the desired language. OSD (On-Screen Display) will display with the selected language.

Selecting the On-screen Display

You can select to display the time, date, frame counter, alarm counter, counter title.

- 1 Turn the power on to all devices used.
- 2 Press the MENU button. The initial menu is displayed. Press the SHIFT (▼) button to move arrow mark (►) to "VCR Mode Set".

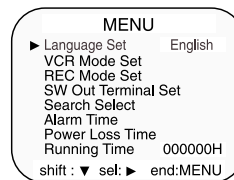

- 3 Press the SHIFT ► button to select the VCR Mode Set, then the VCR Mode Set menu is displayed.

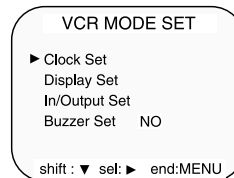

- 4 Press the SHIFT ▼ button, until the arrow mark (▶) points "Display set".
- 5 Press the SHIFT ▶ button to select Display Set. Then the DISPLAY SET menu is displayed.

DISPLAY SET		
DISPLAY		POSITION
▶ Time	No	R-Bottom
Date	No	R-Bottom
Frame Cnt.	No	R-Bottom
Alarm Cnt.	No	L-Top
Counter	No	L-Top
Title	No	L-Top
(- - - - -)		
shift : ▼ set: +- end:MENU		



- The items for which "YES" is set are recorded. The items for which "NO" is set at step 6 above are not recorded.

- 6 Press the SET - (or +) button to set "YES" for the functions described below.

TimeThe time is displayed.

DateThe Month-Day-Year is displayed. **(NTSC)**

The Day-Month-Year is displayed. **(PAL)**

Frame Cnt.....The number of frames is displayed.

Alarm Cnt.....The number of alarms is displayed.

CounterThe counter is displayed.

TitleThe title is displayed.

- A maximum of 20 characters can be used. (alphabet, numbers, space)

- 7 Press the SHIFT ▶ button to set the display position.

- 8 Press the SET - (or +) button to set the position of the time, date, frame cnt. alarm cnt. to "L-Bottom (or R-Bottom).

- If one of 4 items is set, the position of 4 items is changed identically.

- 9 Press the SET - (or +) button to set the position of counter, title to "C-Top" (or "R-Top" or "L-Top")

If one of 2 items is set, the position of 2 items is changed identically.

L-Top / C-Top / R-Top

: Left Top / Center Top / Right Top

L-Bottom / R-Bottom

: Left Bottom / Right Bottom

- 10 Press the MENU button three times, the normal screen is displayed.

The setting procedure is now complete.

Normal Recording



- If the Repeat Rec Set is set to "NO" in the REC MODE SET menu, recording will continue to the end of the tape, then stop and the tape will be ejected.



- A tape recorded on this VCR cannot be played back on another make of time lapse VCR.
- If you press on the REC button and the loaded cassette has no erasure-prevention tab, the VCR will eject the cassette.
- During recording, the Menu button will not function (the menu cannot be accessed).



- If you playback the recorded part where recording check was performed, noise may appear.
- If you change the recording speed during recording, noise or missing signal may result.



- During pause, the image appears on-screen but it is not recorded.
- If a recording pause continues for 5 minutes or more, the VCR will go into stop mode to avoid damage to the tape.

Normal Recording

- 1 Turn the power on to all devices used.
- 2 Load a cassette tape with erasure prevention tab in place.
- 3 Press the REC/PLAY SPEED ▼ (or ▲) button to set the recording speed.
 - The recording speed is displayed on-screen and on the display panel.
 - If you don't want to record the recording speed, counter, title, time, date etc, press the DISPLAY button, then start recording.
- 4 Press the REC button.
 - The "REC" indicator is displayed on the display panel and recording starts.
- 5 To stop recording, press the STOP button.

<Recording Speed>

Recording Speeds & Duration				Recording Intervals Sec.		Rec. Fields/Sec.		Audio Recording		Tape Motion	
NTSC		PAL		NTSC	PAL	NTSC	PAL	NTSC	PAL	NTSC	PAL
T-120	T-160	E-180	E-240	1/60	1/50	60	50	YES	YES	Continuous	Continuous
2(SP)	2.67	3 HR	4 HR	1/60	5/50	60	10	YES	YES	Continuous	Continuous
6(EP)	8	12 HR	16 HR	3/60	7/50	20	7.1	YES	YES	Continuous	Continuous
18(EP)	24	18 HR	24 HR	12/60	9/50	5	5.6	NO	YES	Intermittent	Continuous
24(SP)	32	24 HR	32 HR	18/60	12/50	3.3	4.2	NO	NO	Intermittent	Step
36(SP)	48	36 HR	48 HR	24/60	16/50	2.5	3.1	NO	NO	Intermittent	Step
48(SP)	64	48 HR	64 HR	36/60	24/50	1.6	2.1	NO	NO	Intermittent	Step
72(SP)	96	72 HR	96 HR	48/60	32/50	1.2	1.6	NO	NO	Intermittent	Step
120(SP)	160	120 HR	160 HR	1	40/50	1	1.3	NO	NO	Intermittent	Step
168(SP)	224	168 HR	224 HR	1.4	1.1	0.7	0.9	NO	NO	Intermittent	Step
240(SP)	320	240 HR	320 HR	2	1.6	0.5	0.6	NO	NO	Intermittent	Step
360(SP)	480	360 HR	480 HR	3	2.4	0.3	0.4	NO	NO	Intermittent	Step
480(SP)	640	480 HR	640 HR	4	3.2	0.25	0.3	NO	NO	Intermittent	Step
720(SP)	960	720 HR	960 HR	6	4.8	0.16	0.2	NO	NO	Intermittent	Step
960(SP)	1280	960 HR	1280 HR	8	6.4	0.12	0.1	NO	NO	Intermittent	Step

⚡ (SP) means to be recorded by SP heads. (EP) means to be recorded by EP heads. **(NTSC)**

Record Pause

Recording can be interrupted temporarily.

- 1 Press the PAUSE/STILL button during recording.
 - The "REC" and "II" indicators are displayed on the display panel.
- 2 To resume recording, press the REC button, or press the PAUSE/STILL button again.

Program Timer Recording

There are two program timer recording methods, daily recording or recording on certain days of multiple weeks (weekly recording).

Example 1 : To record on every Thursday from 10 : 00 to 18 : 00 , in 18-hour mode (recording speed)

- 1 Make sure that the set date and time are correct.
- 2 Load a cassette tape with erasure prevention tab in place.
- 3 Press the MENU, SHIFT ▼ button twice to move the arrow mark (▶) located on the "REC Mode Set", SHIFT ▶ button to select "Timer Program Set", SHIFT ▶ button to display the "TIMER PROGRAM SET(1)" menu.

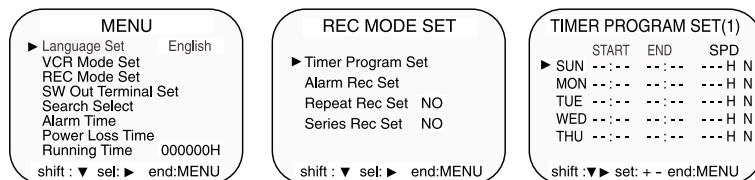

- The white block cursor is on "SUN"(Sunday).
- 4 Press the SHIFT ▼ button, until the cursor is on "THU".
 - 5 Press the SHIFT ▶ button.
 - The cursor is moved to the recording start hour position.
 - 6 Press the SET - (or +) button to set the recording start hour(ex : 10), then press the SHIFT ▶ button.
 - The cursor is moved to the recording start minutes position.
 - 7 Press the SET - (or +) button to set the recording start minute (ex : 00), then the SHIFT ▶ button.
 - The cursor is moved to the recording stop hour position.
 - 8 Press the SET - (or +) button to set the recording stop hour(ex : 18), then press the SHIFT ▶ button.
 - The cursor is moved to the recording stop minutes position.
 - 9 Press the SET - (or +) button to set the recording stop minutes(ex : 00), then press the SHIFT ▶ button.
 - The cursor is moved to the recording speed position.
 - 10 Press the SET - (or +) button to select the recording speed(ex : 18), then press the SHIFT ▶ button.
 - The cursor is moved to the N/Y position.



- If the set stop time is earlier than or the same time as the set start time, the VCR will consider the stop time to be the following day.

11 Press the SET - (or +) button to select "Y".

Y recording will take place

N recording will not take place

Programmed timer recording Example

TIMER PROGRAM SET(1)			
	START	END	SPD
▶ SUN	--:--	--:--	---H N
MON	--:--	--:--	---H N
TUE	10:00	18:00	018H Y
WED	--:--	--:--	---H N
THU	--:--	--:--	---H N

shift : ▼▶ set: + - end:MENU

- Repeat steps 4 to 11 to program timer recordings for other days of the week.
- To set two or more timer recordings the same day of the week, press the SHIFT ▼ button, until the cursor is located in the day of the week for the second recording, then press the SET - (or +) button, to set the desired day of the week. With each press of the SET - (or +) button, the day will change as indicated below.

SET - : ← direction , SET + : → direction



12 Press the MENU button three times, the normal screen is displayed.

13 Press the POWER/TIMER button.

- The timer recording indicator "⏸" will light on the display panel. The VCR is now in timer recording stand-by mode.

Example 2 : To record on everyday from 10 : 00 to 18 : 00, in 18-hour mode (recording speed)



- To modify, cancel timer recording, press the POWER/TIMER button to cancel the timer recording mode.

- 1 Repeat steps 1 to 3 of example 1.
- 2 Press the SHIFT ▼ button, until the cursor is on "DLY". The MENU below is displayed.

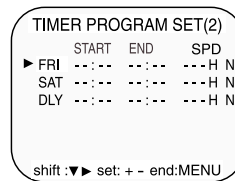

- 3 Repeat steps 5 to 13 of example 1.

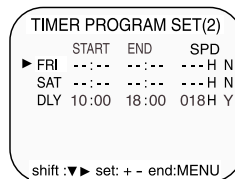

Programmed timer recording Example 2

Changing a Program Timer Recording

- 1 Press the MENU, SHIFT ▼, SHIFT ▶, SHIFT ▶ buttons in sequence to display the TIMER PROGRAM SET(1) menu.
- 2 Press the SHIFT ▶ (or ▼) button, until the cursor is located in the setting to correct.
- 3 Press the SET - (or +) button, to correct the setting.
 - Press the MENU button three times until the normal screen is displayed.
- 4 Press the POWER/TIMER button.

To Cancel a Program Timer Recording

- 1 Repeat step 1 of changing a program timer recording.
- 2 Press the SHIFT ► (or ▼) button until the cursor is located in the "Y" corresponding to the timer recording to cancel.
- 3 Press the SET - (or +) button, to select "N".
- 4 Press the MENU button three times until the normal screen is displayed.
- 5 Press the POWER/TIMER button.
 - The clear button can erase the programmed timer recording in the line that the cursor is located.

Notes...

- During timer recording all the buttons on the VCR, except the STOP button, are disabled. If the STOP button is pressed for three seconds during timer recording, the recording will stop. During timer recording stand-by, press the POWER/TIMER button if the buttons do not respond.
- If there is a power loss, the recording will be interrupted. When the power is restored, the recording will resume if the stop time has not yet been reached, and "PF" will be flashing on the display panel. The VCR internal battery is completely charged after the VCR has been connected to an AC power outlet for 48 hours, and it will maintain all the VCR settings memory for up to 30 days.
- Set the timer recordings so that the recording times do not overlap. If they do, the one with the earliest recording start time will have priority.

(See chart below)

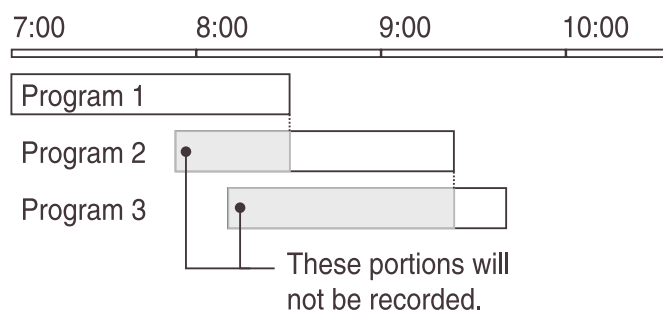

- If the cassette tape is ejected while timer recording is set, the buzzer will be heard 5 times (when the buzzer function is set to "YES").

Alarm Recording

Alarm Recording Setting

Alarm recording is performed when there is an input (trigger) at the ALARM IN terminal, "ALARM" is displayed on the display panel.

- 1 Make all necessary connections.
- 2 Press the MENU, SHIFT ▼, SHIFT ► buttons in sequence to display the REC MODE SET menu .
- 3 Press the SHIFT ▼ button until the arrow mark(►) points to Alarm Rec Set.
- 4 Press the SHIFT ► button to display the ALARM REC SET menu.

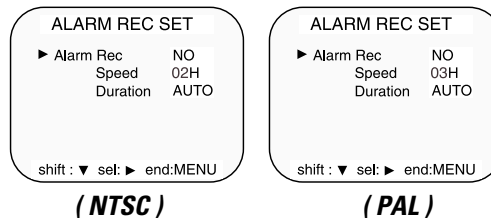

- During alarm recording all buttons are disabled except the STOP button. If the STOP button is pressed, the alarm recording will stop.
- If an alarm trigger is received while alarm recording is in progress, the recording duration for the second alarm will be calculated from that point.
- When there is a power loss during alarm recording, if the power is restored within the recording set duration, alarm recording will continue.

- 5 Press the SHIFT ► button to select "YES" or "NO".
 - YES The alarm recording takes place when there is alarm trigger input
 - NO The alarm recording does not take place

- 6 Press the SHIFT ▼ button to set the Alarm speed.
- 7 Press the SHIFT ► button to select the desired recording speed.

- | | |
|-----------------------------------|-----------------------------------|
| (NTSC) | (PAL) |
| • 2H . . .2-hour mode recording | • 3H . . .3-hour mode recording |
| • 6H . . .6-hour mode recording | • 12H . . .12-hour mode recording |
| • 18H . . .18-hour mode recording | • 18H . . .18-hour mode recording |
| | • 24H . . .24-hour mode recording |

- 8 Press the SHIFT ▼ button to set the alarm duration
- 9 Press the SHIFT ► button to select the desired recording duration.
 - Auto : Records as long as the alarm signal is being input.
(Minimum 2 minutes is recorded.)
 - 3/5/10/15/20/25/30 MIN : Recording for the set duration.(MIN : minute)
 - T.END : Records until the tape end is reached when there is alarm trigger input.



- Alarm Counter Reset can be performed by pressing the CLEAR key in "Alarm Time" of Initial Menu screen.

Alarm Recording Counter Display

During alarm recording, "ALARM" will be flashing on the display panel. The maximum display number of alarm triggers is "35", at the next alarm recording the counter will indicate "00".

Panic Recording

When there is a panic input at the PANIC IN Terminal, panic recording starts and continues to the end of tape in 2-hour recording mode.

Also, PANIC IN indicator will be on.

To release the panic recording, press the STOP key.

Series(Link) Recording

Using 2 VCRs or more, the series recording function lets you switch recording from one unit to the next (only with VCRs of the same model as this one).

Series(Link) Recording Setup

- 1 Connect 2 VCRs or more as illustrated on next page.
- 2 Set the following items as indicated.

Item	VCR No.1	VCR No.2 and on
Cassette tape	Loaded	Loaded
Operation mode	Stop	Stop
Repeat Rec Set	"NO"	"NO"
Series Rec Set	"YES"	"YES"
Timer recording	OFF (not set)	OFF (not set)
Security lock switch (SET LOCK switch)	"OFF"	"ON"

- 3 Press the REC button on VCR No.1.
 - *Recording will start in series recording mode.*



- During series recording, autorepeat recording or timer recording are not possible.
- If in the REC MODE SET menu, "Series Rec Set" is set to "NO", series recording will not be possible.

4 Set the security lock on VCR No.1.

- When the end of the tape on VCR No.1 is reached, the output at the SERIES OUT terminal will switch signal. This will start recording on VCR No.2, the tape will stop and be ejected on VCR No.1.

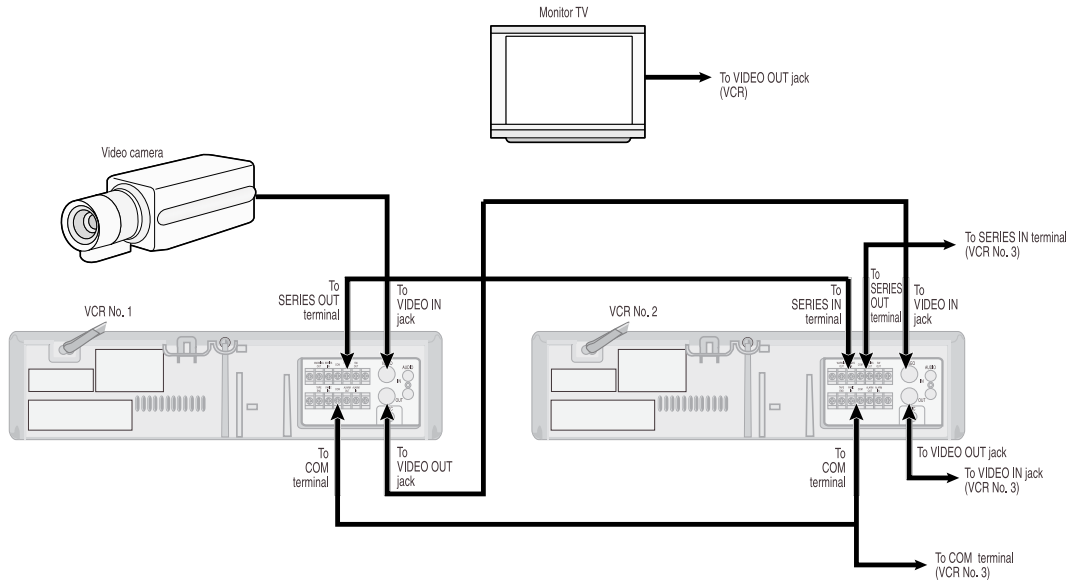
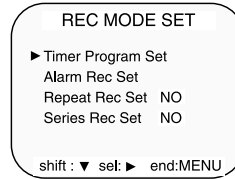

Autorepeat Recording

Autorepeat Recording

The same tape can be recorded over many times.

- 1 Press the Menu, SHIFT ▼, SHIFT ► button in sequence to display the REC MODE SET menu.

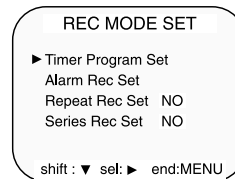

- *If during autorepeat recording there is an alarm trigger, "ALARM" is displayed on the display panel and alarm recording will take place. Autorepeat recording will continue after alarm recording has completed its programmed duration.*

- 2 Press the SHIFT ► button to make the arrow mark (►) point to Repeat Rec Set.
- 3 Press the SHIFT ► button to set the desired autorepeat recording mode.
NO Autorepeat recording doesn't take place.
YES Autorepeat recording takes place.
"R.REC" will light on the display panel.
- 4 Press the Menu button two times, the normal screen is displayed.
 - *The setting procedure is now complete.*
- 5 Press the REC button.
 - *Recording will start. When the tape's end is reached, the VCR will rewind it to the beginning regardless of the counter memory, and recording will resume.*

Normal Playback



- A slow motion effect or accelerated playback effect can be achieved by using a slower or faster playback speed than the speed used for recording.

Normal Playback

- 1 Turn on the power to the TV monitor.
- 2 Load the video cassette tape.
- 3 Press the REC/PLAY SPEED ▼ (or ▲) button to select the playback speed.
 - The selected playback speed is displayed on the display panel
 - A tape recorded with EP heads can be played in 6-hour, 18-hour modes (**NTSC ONLY**).
 - A tape recorded with SP heads can be played in 2-, 24-, 36-, 48-, 72-, 96-, 120-, 168-, 240-, 360-, 480-, 720-, 960-hour modes (**NTSC ONLY**).
 - The picture quality recorded by EP heads can be lower than SP heads (**NTSC ONLY**).
 - A tape recorded can be played in 3-, 12-, 18-, 24-, 36-, 48-, 72-, 96-, 120-, 168-, 240-, 360-, 480-, 720-, 960-hour modes (**PAL ONLY**).
- 4 Press the PLAY button.
 - Playback starts.
 - If necessary, adjust the tracking to eliminate the noise from the picture.
- 5 To stop playback, press the STOP button.
 - To advanced or rewind the tape, press the FF/CUE or REW/REVIEW button.

Tracking Control

If there is noise in the image during playback,



- Noise will appear in the image when audio playback is used in 18-hour mode (**NTSC**) or 6,12, 18 and 24-hour modes (**PAL**).

- 1 While looking at the playback picture, press and hold the TRACKING + button to minimize the noise.
- 2 If it cannot be minimized, press the TRACKING - button.

Audio Playback

Audio playback is only possible in 2, 6 and 18-hour modes (**NTSC**) or 3,12,18 and 24-hour modes (**PAL**).

The playback speed has to be the same as the recording speed, for normal playback of the audio.

For a tape recorded in 2, 6 and 18-hour modes (**NTSC**) or 3,12,18 and 24-hour modes (**PAL**), to playback the audio, press the AUDIO ON button after pressing the PLAY button. "A" will be displayed to the left of the playback speed on the display panel. Press the AUDIO ON button again to remove "A".

Special Playback



- During picture search, noise (horizontal bars) will appear in the picture.
- The sound is muted.



- If still mode continues for 5 minutes or more, the VCR will go into stop mode to avoid damaging the tape.
- If the image is unstable (rolling vertically), adjust the tracking control to correct.



- During recording check operations, recording is suspended momentarily.

Picture Search

- 1 Press the FF/CUE (or REW/REVIEW) button, during normal playback.
 - The image can be seen while the tape is advanced (or rewound) at high speed.
- 2 To return to normal playback, press the PLAY button.

Still Image

- 1 Press the PAUSE/STILL button, during normal playback.
 - A still image can be viewed.
- 2 To return to normal playback, press the PLAY button.
 - With each press of the PAUSE/STILL button, the still image is advanced one image (frame).

Vertical Lock Control

During still image mode,

- 1 Press the TRACKING + button to reduce the vertical rolling of the image.
- 2 If it cannot be corrected, press the TRACKING - button.

Slow

- 1 With each press of the FF button, during still image mode, the slow speed will change as indicated below. 1/15times → 1/20times → 1/30times (forward direction)
- 2 With each press of the REW button, during still image mode, the slow speed will change as indicated below. 1/15times → 1/10times → 1/5times (forward direction)
- 3 To return to normal playback, press the PLAY button.

Recording Check

During recording, press the REC CHECK button.

- The tape will be rewound for about 5 seconds and slow play mode will be performed. The VCR will then return to the previous recording mode.



- *The start time in Time/Date Search can be different according to its recording mode.*
- *Only the date/hour except minute/second can be searched in SEARCH SELECT screen.*

Time/Date Search

- 1 Press the Menu button to display the initial menu.
- 2 Press the SHIFT ▼ button to select Search Select, then press the SHIFT ► button to display the SEARCH SELECT menu.



- 3 Move the arrow mark(►) to "Time" in the Time/Date Search mode as you want to search.
- 4 Press the SET - (or +) button to enter the time as you want to search.
- 5 Press the SHIFT ► button to move the cursor to "Date", then press the SET - (or +) button to enter the date as you want to search.
- 6 Press - (or +) button to proceed in reverse (or forward) direction.
 - *The display returns to the normal screen.*
 - *The VCR will advance (or rewind) the tape at high speed.*
 - *To cancel the Time/Date Search mode, press the STOP button.*
- 7 While the desired recording is reached, press the PLAY button.
 - *Playback will start, and Time/Date Search is cancelled.*

Alarm Search

- 1 Repeat steps 1 to 2 of Time/Date Search.
- 2 Move the arrow mark(►) to search number.
- 3 Press the SET -(or +) button to enter the number of alarm marks you want to search.
- 4 Press the SHIFT ▼ button to select FF or REW, then press - (or +) to proceed in reverse (or forward) direction.

- The display returns to the normal screen.
- The VCR will locate the desired alarm recording and begin playback.

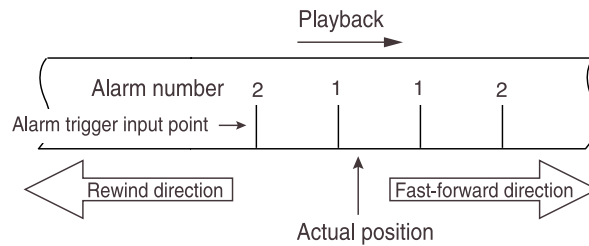

Alarm Scan

- 1 Repeat steps 1 to 2 of Time/Date Search.
- 2 Move the arrow mark (▶) to FF or REW in Alarm Search Mode.
- 3 Press the SHIFT ▶ button to search forward or in reverse without entering a specific alarm number.
 - The display returns to the normal screen.
 - The VCR will advance (or rewind) the tape at high speed, and playback the first 5 seconds of every alarm recording.
 - To cancel the alarm scan mode, press the STOP button.
- 4 While the desired recording is being played back, press the PLAY button.
 - Playback will start, and alarm scan is cancelled.

Zero Search

- 1 Repeat steps 1 to 2 of Time/Date Search.
- 2 Press the SHIFT (▼) to move the arrow mark (▶) to Zero Search.
- 3 Press the SHIFT ▶ button to rewind the tape to the zero position.

Other Functions



- When you insert a cassette, the counter always resets to zero.
- There is no tape counter indication for the blank portions of tape.
- In the 2-hour (**NTSC**), 3-hour (**PAL**) recording speed mode only, the tape counter indicates real hours, minutes and seconds.
- In the other SP recording speed modes (24H, 36.....960H), the tape counter indication is a ratio of the 2-hour mode base indication. (In 24-hour recording mode, each "second" of the tape counter actually represents approximately $24/2 = 12$ real seconds.) (**NTSC ONLY**)
- In the other EP recording speed modes (18H), the tape counter indication is a ratio of the 6-hour mode base indication. (In 18-hour recording mode, each "second" of the tape counter actually represents approximately $18/6 = 3$ real seconds.) (**NTSC ONLY**)
- In the other recording speed modes (12H, 18, 24.....960H), the tape counter indication is a ratio of the 3-hour mode base indication. (In 24-hour recording mode, each "second" of the tape counter actually represents approximately $24/3 = 8$ real seconds.) (**PAL ONLY**)
- There may be a slight discrepancy between the position shown on the tape counter and the actual tape position.
- When rewinding the tape past the "0H 00M 00S" position ("0H 00M 00S" on the display panel), a minus(-) is displayed.

Tape Counter (Zero Search)

Using the counter, it is easy to find a desired recording.

- 1 Press the CLEAR button, at the beginning of the desired recording.
 - The counter will be reset to "0H 00M 00S" (on screen).
 - The counter will be reset to "0H 00M 00S" (on the display panel).
- 2 After recording or playback, press the Menu button to display the initial menu.
- 3 Press the SHIFT ▼ button to move the arrow mark (▶) to Search Select.
- 4 Press the SHIFT ▶ button to display the SEARCH SELECT menu. The SEARCH SELECT menu is displayed.

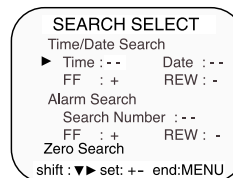



- 5 Press the SHIFT ▼ button to move the arrow mark (▶) to Zero Search.
- 6 Press the SHIFT ▶ button to search the counter "0H 00M 00S" ("0H 00M 00S" on the display panel).
 - The display returns to the normal screen.
 - The tape is rewound or advanced to the counter "0H 00M 00S" reading ("0H 00M 00S" on the display panel).

Setting the Security Lock (Set Lock)

The security lock function is designed to prevent accidental stopping of recording if the STOP button is pressed inadvertently.



- While the security lock is engaged, all commands are disabled.
- The security lock should not be engaged while a menu is displayed.



- 1 Set the SET LOCK switch to "ON" position.
 - "  " is displayed on the display panel.
- 2 To cancel the security lock, set the SET LOCK switch to "OFF" position.
 - "  " will be erased from the display panel.

Setting the SW Out Terminal Output





Synchronization pulses for multiplexers can be obtained from the SW OUT terminal.

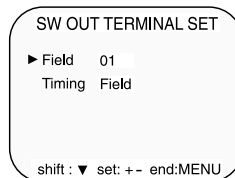

- If "TIMING" is set to FRAME (see step 6), "FRAME" will be indicated instead of "FIELD".

- 1 Press the MENU button, to display the initial menu.
- 2 Press the SHIFT  button to move the arrow mark() to SW OUT Terminal Set.
- 3 Press the SHIFT  button to display the SW OUT TERMINAL SET menu.



- 4 Press the SHIFT  button to set "FIELD" (or "FRAME").
 - With each press of the SHIFT  button, the setting will change as indicated below.
- 5 Press the SHIFT  button, to select Timing.
- 6 Press the SHIFT  button to set the "TIMING".
 - FIELD . . . 1 pulse is output after each set number of fields.
 - FRAME . . 1 pulse is output after each set number frames.
- 7 Press the MENU button, the normal screen is displayed.
 - The setting procedure is now complete.



In the following cases, the buzzer will be heard approximately 5 times.

- If the REC button is pressed while a cassette without erasure-prevention tab is loaded.
- If the TIMER button is pressed while a cassette without erasure-prevention tab is loaded.
- If there is a series recording input while a cassette without erasure-prevention tab is loaded.
- If the TIMER button is pressed without inserting a cassette.



- If "NO" is set, the buzzer will not operate.

Setting the Buzzer

- 1 Press the MENU button to display the initial menu.
- 2 Press the SHIFT ► button to select VCR Mode Set. The VCR Mode Set menu is displayed.

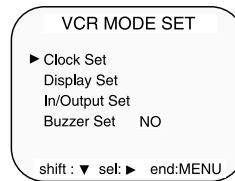

- 3 Press the SHIFT ▼ button to move the arrow mark(►) to Buzzer Set.
- 4 Press the SHIFT ► button to set "YES" for the functions described below.
 - The buzzer will be heard whenever a button is pressed.



- *The data for the previous alarm recordings, past 35, is erased.*

Checking the Alarm Recording Times

- 1 Press the MENU button to display the initial menu.
- 2 Press the SHIFT ▼ button to move the arrow mark(▶) to Alarm Time.
- 3 Press the SHIFT ▶ button to display the ALARM TIME menu.

ALARM TIME		
No	Date	Time
35	10/30	01:56
34	10/21	01:30

next : ▼ exit:MENU

- *The number of alarm triggers and the 35 most recent alarm recording times are displayed.*

- 4 Press the MENU button twice, the normal screen is displayed.

Checking Power Loss Times



- *POWER LOSS
the number of power losses and the date and time of the 35 most recent power loss and recovery are displayed.*

- 1 Press the MENU button to display the initial menu .
- 2 Press the SHIFT ▼ button to move the arrow mark(▶) to Power Loss Time.
- 3 Press the SHIFT ▶ button to display the Power Loss Time menu.

POWER LOSS TIME			
35	Fail	12/30	08:00
	Ret	12/30	20:20
34	Fail	12/29	07:00
	Ret	12/29	07:30

next : ▼ exit:MENU

- *The number of power losses, and the 35 most recent power loss times are displayed.*

- 4 Press the MENU button twice, the normal screen is displayed.

Checking Usage Duration

- 1 Press the MENU button to display the initial menu.



- *The Running Time data cannot be reset even though the reset button is pressed. If the RESET button is pressed, all data can be reset except the running time data.*

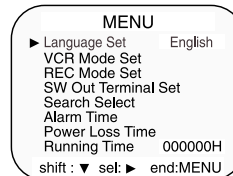

Running Time : The video heads usage duration.

- 2 Press the MENU button, the normal screen is displayed.

Setting In/Out terminals

- 1 Press the MENU button to display the initial menu.
- 2 Press the SHIFT ▶ button to display the VCR Mode Set menu.
- 3 Press the SHIFT ▼ button to move the arrow mark(▶) to In/Output Set.
- 4 Press the SHIFT ▶ button to display the IN/OUTPUT SET menu.

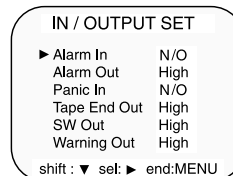

- 5 Press the SHIFT ▼ button to move the arrow mark(▶) for the desired item.
- 6 Press the SHIFT ▶ button to set "Open" or "Closed", "High" or "Low".
- 7 Press the MENU button three times, the normal screen is displayed.

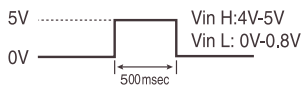

ALARM INPUT Terminal

- 1) "N/C" (Normally Closed Switch Circuit)

If the input becomes DC 5V for 500 msec or more, the VCR starts alarm recording.

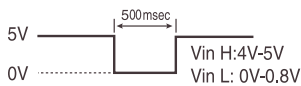

- 2) "N/O" (Normally OPEN Switch Circuit)

If the input becomes 0V for 500 msec or more, the VCR starts alarm recording.

ALARM OUTPUT Terminal

- 1) "High"

When an alarm input is received and the unit is recording, the output becomes DC 5V. Once the alarm recording is over, the output returns to 0V.

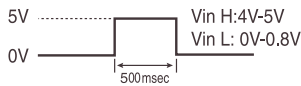

- 2) "Low"

When an alarm input is received and the unit is recording, the output becomes 0V. Once the alarm recording is over, the output returns to DC 5V.

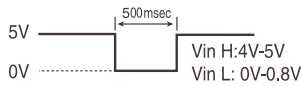

PANIC INPUT Terminal

- 1) "N/C" (Normally Closed Switch Circuit)

If the input becomes DC 5V for 500 msec or more, the VCR starts panic recording.

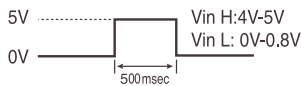

- 2) "N/O" (Normally OPEN Switch Circuit)

If the input becomes 0V for 500 msec or more, the VCR starts panic recording.

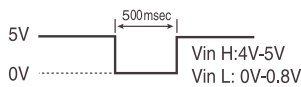

TAPE END(OUT) Terminal

- 1) "High"

During recording, when the end of the tape is reached, the output becomes DC 5V.



- 2) "Low"

During recording, when the end of the tape is reached, the output becomes DC 0V.



SW OUTPUT Terminal

While recording, a pulse signal(DC 5V) is output at the SW OUT terminal after each recording period. This terminal is usually connected to the switch input of devices like a camera switching unit, or a quad compressor.

1) Low

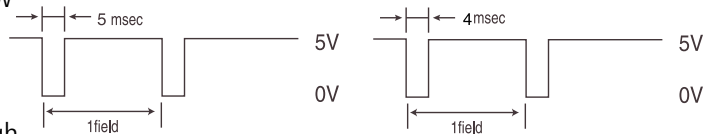

2) High

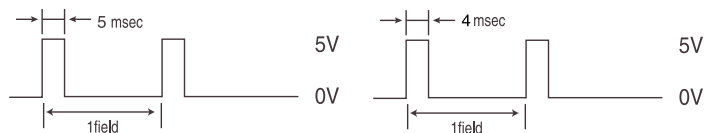

(NTSC)

(PAL)

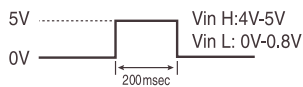

Vin H: 4V-5V
Vin L: 0V-0.8V

SERIES OUTPUT Terminal

During recording, when the end of the tape is reached, the output becomes DC 5V .

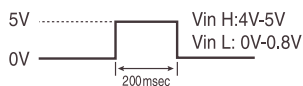

Vin H: 4V-5V
Vin L: 0V-0.8V

SERIES INPUT Terminal

If the input becomes DC 5V for 200 msec or more, the VCR starts series recording.

WARNING OUTPUT Terminal

1) "High"

If the error display on the display panel continues to flash, the output becomes DC 5V. If the POWER button is pressed, the emergency mode is released. then the output becomes 0V.



Vin H: 4V-5V
Vin L: 0V-0.8V

2) "Low"

If the error display on the display panel continues to flash, the output becomes 0V. If the POWER button is pressed, the emergency mode is released. then the output becomes DC 5V.



Vin H: 4V-5V
Vin L: 0V-0.8V

Maintenance

Daily Inspection

The following daily inspections are recommended in order to assure long-term and trouble-free operation of the unit.

The daily inspections are particularly important if using autorepeat recording.

Inspection Procedure



- If the security lock is engaged, it has to be released before proceeding with the inspection.
- If any problem is discovered during the inspection, unplug the power cord and consult your dealer.

- 1 Turn on the power to the camera, TV monitor and other connected devices.
- 2 Check that the image received on the TV monitor is correct.
- 3 Check that the on-screen display of the date and time is correct.
- 4 Press the REW button to rewind the recorded tape a few seconds.
- 5 Press the PLAY button and check that the playback image is correct.
 - Check in particular playback of time lapse recording (24 hour mode)
- 6 Check that the recorded date and time are correct.

Servicing Periodically

The requirement for professional servicing on the VCR varies depending on the usage and environment of the deck. The following table provides a recommended guide on when to contact a service representative for maintenance.

WARNING

Do cleaning and lubricating from time to time even if the deck is not used.

Items	Maintenance period(Hrs)				
	1,000	2,000	3,000	4,000	5,000
DRUM TOTAL ASS'Y	*	▲	*	▲	*
CAPSTAN MOTOR	*	▲	*	▲	*
L/C BRKT TOTAL ASS'Y	*	▲	*	▲	*
REEL BELT	*	▲	*	▲	*
IDLER PLT ASS'Y		*		▲	
S/T REEL TABLE ASS'Y		*		▲	
T-SUB BRAKE ASS'Y		▲		▲	
BAND BRAKE ASS'Y		▲		▲	
MAIN PLATE		▲		▲	
L-LOADING ASS'Y		▲		▲	
PINCH LEVER T/T ASS'Y		*	▲		*
AC HEAD TOTAL ASS'Y			▲		
FE HEAD					▲
REEL GEAR TOTAL ASS'Y		*	▲		*

* : Check and replace parts if necessary

▲ : Replacement

Troubleshooting Guide

If the unit does not operate normally when you follow the instructions indicated in the manual, please refer to the table below.

SYMPTOM	POSSIBLE CAUSE	CORRECTIVE ACTION
No power.	The power cord is not correctly connected to the wall outlet. The unit is in timer recording stand-by mode.	<ul style="list-style-type: none"> - Connect the power cord firmly into the wall outlet. - This is normal, not a malfunction.
No image displayed on the monitor TV.	The connections are not correct. The power to the camera and/or monitor TV is not turned on.	<ul style="list-style-type: none"> - Check that all connections are correct. - Turn all connected devices power on.
The buttons do not respond.	<p>The unit is in timer recording stand-by mode. Alarm recording.</p> <p>Panic recording.</p> <p>The security lock(SET LOCK) is engaged.</p>	<ul style="list-style-type: none"> - Press the POWER/Timer button. - Wait for the alarm recording to end. - Press the STOP button for 3 seconds to stop. - Wait for the panic recording to end. - Press the STOP button for 3 seconds to stop. - Cancel the security lock.
Unit will not go into record mode.	The loaded cassette has no erasure prevention tab.	<ul style="list-style-type: none"> - Load a cassette tape with erasure prevention tab or cover the tab hole with adhesive tape.
Autorepeat.	<p>"NO" is selected for autorepeat recording in the REC MODE SET menu.</p> <p>During autorepeat recording when there is an alarm input, autorepeat recording is canceled.</p>	<ul style="list-style-type: none"> - Be sure to select "YES" for autorepeat recording. - Set "YES" again for autorepeat recording.
Timer recording.	<p>The date and time are not correct.</p> <p>The unit is not set to timer recording stand-by mode.</p> <p>"N" is selected for the TIMER PROGRAM SET.</p>	<ul style="list-style-type: none"> - Set the date and time correctly. - Press the POWER/TIMER button to display "☺" on the display panel. - Be sure to select "Y" for the TIMER PROGRAM SET.

SYMPTOM	POSSIBLE CAUSE	CORRECTIVE ACTION
Alarm recording.	"NO" is selected for alarm recording in the ALARM REC SET menu.	- Be sure to select "YES" for alarm recording.
Noise in the playback picture.	The tracking must be adjusted. The video heads need cleaning.	- Adjust it by using the manual tracking. - Press the PLAY button in the playback mode. - Clean the video heads.
The date and time are not recorded.	"NO" is selected for the date and time in the DISPLAY SET menu. The date and time go off the ON-SCREEN by pressing the DISPLAY button.	- Be sure to select "YES" for the display. - Press the DISPLAY button to show the date and time.
The cassette tape cannot be ejected	Problem with the system or tape.	- Unplug the power cord then plug it back in.

Periodic Inspection and Maintenance

Periodic inspection and maintenance should be referred to your dealer. If there is noise in the playback picture, and it cannot be corrected using the tracking control, it may indicate that the video heads need cleaning. The video heads should be cleaned and inspected every 1,000 hours. The video heads usage can be checked using initial menu, running time.

System Down

If the unit does not function at all, try the following.



- Press the RESET button for more than 5 seconds to perform the reset. Running Time will not be reset.

- 1 Unplug the power cord then plug it back in.
- 2 Reset the memory. (Press the RESET button. Under normal conditions, do not touch the RESET button)
- 3 If the problem is not corrected after performing steps 1 and 2, consult your dealer.

Specifications

	NTSC	PAL
GENERAL SPECIFICATIONS		
Recording method	Dual-azimuth 4-head rotating helical scanning system	
Audio recording	In 2, 6, and 18 hour modes	In 3, 12, 18, and 24 hour modes
Tape speed	33.35 m/sec (2 hour mode)	23.39 m/s (3 hour mode)
Specified video cassette tape	VHS 1/2 inch video cassette tape	
Recording/playback time	24H Model : L2, L6, L18, 24, 36 hours (when using T-120 tape) 960H Model : L2, L6, L18, 24, 36, 48, 72, 96, 120, 168, 240, 360, 480, 720, 960 hours (when using T-120 tape)	24H Model : L3, L12, L18, L24, 36 hours (when using E-180 tape) 960H Model : L3, L12, L18, L24, 36, 48, 72, 96, 120, 168, 240, 360, 480, 720, 960 hours (when using E-180 tape)
Fast forward/rewind time	Within 3 minutes (when using T-120 tape)	Within 3 minutes (when using E-180 tape)
Television system	NTSC color TV system	PAL color TV system
VIDEO		
Recording method	Luminance signal : FM recording Color signal : Down-converted subcarrier direct recording	Luminance signal : FM recording Color signal : Down-converted subcarrier phase shift recording
Video input	1 Vp-p, BNC, 75Ω, unbalanced	
Video output	1 Vp-p, BNC, 75Ω, unbalanced	
Horizontal resolution	Black & white mode 350 lines	
	Color mode 300 lines	
AUDIO		
Input	RCA pin jack more than 47kΩ -8.8dBm, unbalanced	
Output	RCA pin jack less than 1.5kΩ -7.8dBm, unbalanced	
Microphone input	-60 dBs, 3.5mm mini jack, 10kΩ, unbalanced	
CONNECTORS		
Alarm input	DC 4~5V(Open), DC 0~0.8V(Closed)/5.7kΩ	
Alarm output	DC 4~5V(H), DC 0~0.8V(L)/5.7kΩ	
Panic input	DC 4~5V(Open), DC 0~0.8V(Closed)/5.7kΩ	
End output	DC 4~5V(H), DC 0~0.8V(L)/5.7kΩ	
Warning output	DC 4~5V(H), DC 0~0.8V(L)/5.7kΩ	
Series input	DC 4~5V(H), DC 0~0.8V(L)/5.7kΩ	
Series output	DC 4~5V(H), DC 0~0.8V(L)/5.7kΩ	
Switch output	DC 4~5V(H), DC 0~0.8V(L)/5.7kΩ	
Common	0V(GND)	
OTHER SPECIFICATIONS		
Operating temperature range	41°F ~ 104°F	
Operating humidity range	80% or less	
Power requirements	AC90 ~ 240V, 50/60 Hz	
Power consumption	17W	11W
Dimensions	360(W) x 90(H) x 289(D)	
Weight	approximately 4kg	

NOTE : The specifications and external appearance of this unit are subject to change without notice.

