



## INSTALLATION AND MAINTENANCE INSTRUCTIONS

**MAGDUOSRSQ** MAGDUO Wall Sounder Red  
**MAGDUOSWSQ** MAGDUO Wall Sounder White

[https://www.espuk.com/technical\\_support/product\\_manuals/?cat=4](https://www.espuk.com/technical_support/product_manuals/?cat=4)

### General Description

The MAGDUO Wall Sounder unit allows for audible indication when the system enters an alarm condition. This device is compatible with the MAGDUO 2-wire range of Fire Alarm equipment and comprises a 2-wire zone-powered sounder. This device may be installed on the same zone as the FlexiPoint detector/sounder and associated MAGDUO devices.

### Before Installation

The Sounder must be installed in compliance with the control panel installation manual. The installation must also meet the requirements of any local authority. For maximum performance the sounder should be installed in compliance to BS5839 Pt1 : 2017.

### Spacing

It is recommended spacing of sounders in accordance with BS5839 Pt1. For more specific information regarding sounder spacing, placement and special applications please refer to BS5839 Pt1 : 2017.

### Device Installation

#### **Surface Mounting**

Fix the surface back box to a flat vertical surface using at least two of the four mounting holes provided. The back box may be drilled to allow cable access as required. A 20mm hole is already provided at the rear. Zone cabling may be connected to the terminals in the back box.

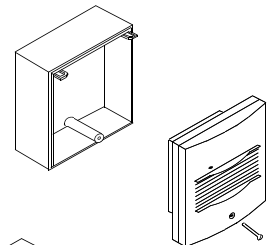

#### **Flush Mounting**

The MAGDUO Wall Sounder may be flush mounted utilising the optional adaptor plate, combined with any standard single gang flush mounting back box (with a minimum internal depth of 47mm).

After installing the back box securely, attach the adaptor plate using the two screws provided, and terminate your cables directly into a flying terminal block.

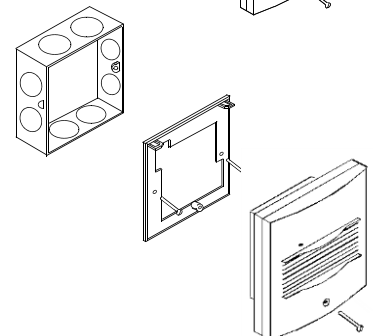

#### **Installation 2nd Fix**

Once all testing has been carried out on the cabling and 'continuity & integrity' has been proven, the MAGDUO Wall Sounder front may be installed.

Connect the wires from the MAGDUO Wall Sounder front in to the appropriate terminals in the back box according to the wire colours. The MAGDUO Wall Sounder front may then be installed by locating the upper mounting hooks into the back box and then pushing the unit gently home. The single fixing screw may then be tightened as required.

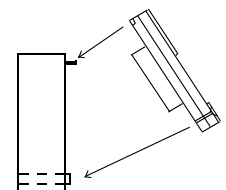

Please remember that all high voltage testing must be carried out before the installation of the MAGDUO Wall Sounder front unit, otherwise the electronics will be damaged.

# Connections

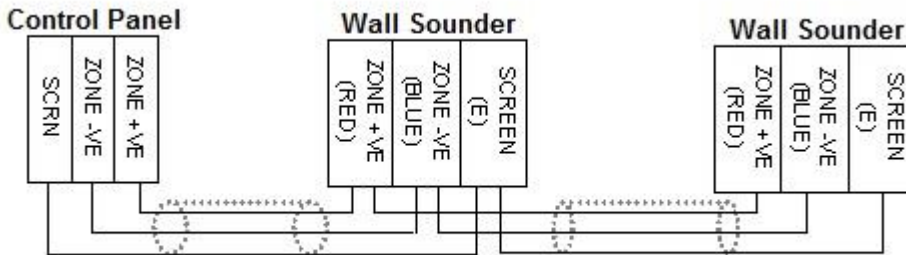
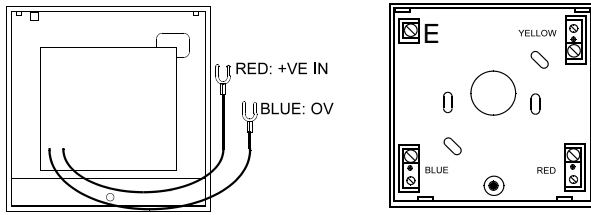

MAGDUO Wall Sounders can be mixed on the same zone as other types of MAGDUO device. The above diagram shows how to make the zone positive, zone negative and screen connections between the control panel and MAGDUO Wall Sounder. Refer to the instruction leaflets supplied with other MAGDUO devices for their equivalent wiring/terminal labelling details.

Please note that the E terminal on the MAGDUO Wall Sounder should only be connected to the zone cable screen and NOT to the building earth. The cable screen is connected to earth at the panel end only, via the zone “SCRNR” terminal (or EARTH terminal on the MAGDUO panel). It is important to maintain the screen continuity in order to protect against data corruption from interference.

**Remember that the device at the end of the line must have its EOL signal activated using the relevant DIL switch. Do not use a resistor or capacitor (or another manufacturer’s End of Line device) as the end of line, as this may prevent correct operation of the zone.**

## DIL Switch Settings

The detector DIL switches may be used to program the operation of the sounder. They may be altered whilst the device is still powered or the system may be powered down completely.

The last device on the circuit must have the EOL signal enabled (switch number 1 in the ‘ON’ position).

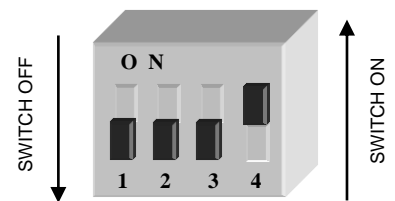

		DIL SWITCH SETTINGS			
		1	2	3	4
<b>End of line</b>	Enabled	ON			
	Disabled	OFF			
<b>Sound Levels</b>	High		ON		
	Low		OFF		
<b>Sound Patterns</b>	Sound OFF			ON	ON
	Dual Tone UK Evacuate – 800 & 970 Hz			ON	OFF
	Slow Whoop Up - 500 to 1200 Hz sweep up			OFF	OFF
	Dual Tone French Warble – 440 & 550 HZ			OFF	ON

## Technical Data

Dimensions	Width .....89 mm
	Height .....89 mm
	Flush Depth Protruding .....34 mm
	Surface Depth .....62 mm
Operating Temperature	.....-10°C to +50°C
Voltage Ranges	DC Output from Mains Powered Panel ...25.5 to 35V DC
	DC Output from Battery Powered Panel .20 to 26V DC
Operating Current (Typical)	Quiescent .....185 uA
	End of line ON if applicable .....175 uA <i>(in addition to Quiescent)</i>
	Alarm Sounding – Sounder High.....14.5 mA
	Alarm Sounding – Sounder Low .....12.6 mA
Device Loading Units	Max Loading Units per zone .....160 DLU
	Sounder High. ....14.5 DLU
	Sounder Low .....13.0 DLU
Volume Level	Sounder High .....85+ dB(A)
(@ 1m anechoic, Dual Tone)	Sounder Low .....65+ dB(A)
Flammability	.....UL94-V2
IP Rating	.....IP 21C

## Technical Support

Due to the complexity and inherent importance of a life risk type system, training on this equipment is essential, and commissioning should only be carried out by competent persons.

ESP's policy is one of continual improvement and the right to change a specification at any time without notice is reserved. Whilst every care has been taken to ensure that the contents of this document are correct at time of publication, ESP shall be under no liability whatsoever in respect of such contents. E&OE.

www.espuk.com

 0832	
Elite Security Products LTD Unit 7 Target Park, Shawbank Road, Lakeside, Redditch, B98 8YN England 11 DoP-MAGDUOSWSQ-01	
<b>EN54-3: 2001 +A1: 2002 +A2: 2006</b>  <b>Sounder Technical Data See: 26-1649</b>  <b>Intended for use in the fire detection and fire alarm  Systems in and around buildings</b>	
Essential characteristics	Performance
Nominal activation conditions/Sensitivity, Response delay (response time) and performance under fire conditions	Pass
Operational reliability	Pass
Durability of operational reliability and response delay, Temperature resistance	Pass
Durability of operational reliability, Vibration resistance	Pass
Durability of operational reliability, Humidity resistance	Pass
Durability of operational reliability, Corrosion resistance	Pass
Durability of operational reliability, Electrical stability	Pass
Durability of operational reliability, Resistance to ingress	Pass