

Mains Powered

Ei3028 / 3018

Alarms

Instruction Manual

Read and retain carefully for as long as the product is being used. It contains vital information on the operation and installation of your Alarm. The leaflet should be regarded as part of the product.

If you are just installing the unit, the leaflet **MUST** be given to the householder. The leaflet is to be given to any subsequent user.



Contents

| | |
|-----------------------------------|-----------|
| Installer Guide | 4 |
| 1. Introduction | 4 |
| 1.1 Overview | 6 |
| 1.2 Technical Specifications | 8 |
| 2. Installation | 10 |
| 2.1 Important Safety Instructions | 11 |
| 2.2 Where to locate the Alarm? | 12 |
| 2.3 Which Alarm in what room? | 13 |
| 2.4 Where in the room? | 14 |
| 2.5 Unsuitable locations | 15 |
| 2.6 Mounting and wiring | 17 |
| 2.7 Interconnecting Alarms | 21 |
| 2.8 Removing the Alarm | 23 |

| | |
|--|-----------|
| User Guide | 24 |
| 3. What is Carbon Monoxide? | 24 |
| 3.1 Symptoms of CO poisoning | 26 |
| 3.2 How to protect your family against CO | 27 |
| 3.3 How does your Alarm work | 28 |
| 4. Testing | 32 |
| 4.1 Testing and maintaining your Alarm | 33 |
| 4.2 Cleaning your Alarm | 35 |
| 5. What to do in case of fire alarm | 37 |
| 6. What to do in case of CO alarm | 39 |
| 7. Troubleshooting and Indicator summary tables | 41 |
| 8. Important safeguards | 51 |
| 9. Service and Guarantee | 54 |
| 9.1 Getting your Alarm serviced | 55 |
| 9.2 Guarantee | 55 |

Installer Guide

1

Introduction

The Ei3028 is a dual sensor Heat and Carbon Monoxide (CO) Alarm. It contains a proven electrochemical CO sensor to detect the presence of toxic levels of Carbon Monoxide as well as an independent fast acting Class A1 Thermistor sensor to detect dangerous levels of heat. The combination of CO and Heat detection makes it an ideal Alarm for kitchens, utility rooms and garages where fuel burning appliances maybe installed.

The Ei3018 is a Carbon Monoxide Alarm which contains a proven electrochemical CO sensor to detect the presence of toxic levels of Carbon Monoxide (CO). It is ideal for kitchens, garages, utility rooms and other areas where fuel burning appliances maybe installed.

Up to 12 Alarms can be interconnected so that if one senses fire or dangerous levels of CO, all Alarms sound. It can be a hardwired interconnection or a wireless interconnection (for the latter an Ei3000MRF SmartLINK module needs to be added to each Alarm – sold separately)

The Ei3000 series is supplied with a base that allows very quick and simple installation of the Alarm as it automatically connects both mains power and battery as the detector head slides onto the base. Each Alarm comes with built-in rechargeable backup batteries to power the Alarm in the event of a mains failure.

AudioLINK

The Ei3000 series Alarms are AudioLINK enabled. This feature allows the user to download information from the Alarm through the use of a mobile App. For more information on using this feature, please refer to the relevant section on www.eielectronics.com or www.aico.co.uk.

1.1 Overview

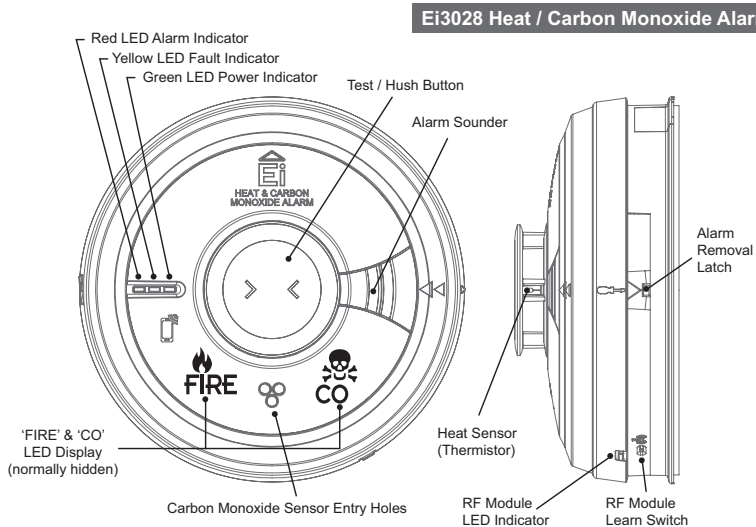

Ei3018 Carbon Monoxide Alarm

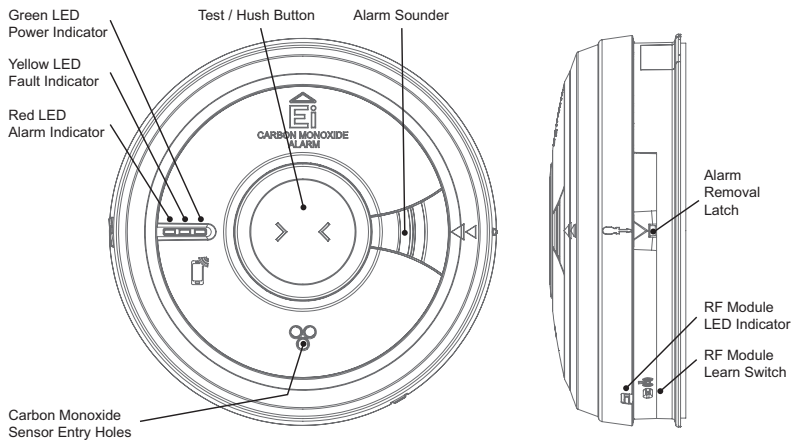

1.2 Technical Specifications

| | |
|-------------------------------|---|
| Heat Sensor | Thermistor (Ei3028) Class A1 detection – Alarm is triggered at 58°C |
| Carbon Monoxide Sensor | Electrochemical (Ei3028 and Ei3018) |
| Power Supply | 100-250V AC, 50Hz, 0.25W |
| Battery Backup | Built-in 10-year rechargeable Vanadium Pentoxide Lithium cells. Fully charged, the battery will provide up to 6 months (without module fitted) or 3 months (with module fitted) back-up without mains power |
| Alarm Sounder | Piezoelectric Horn |
| Alarm Sound Level | 85dB(A) at 3 meters (min) |
| Memory Feature | Indicates that the Alarm has previously detected fire and or dangerous levels of CO |
| Display | Ei3028 - indicates FIRE or CO |
| Self Test | Sensors, battery and electronics are automatically tested periodically |
| Test/Hush Button | Checks sensors, electronics, display, interconnection and sounder. If the unit is in alarm when pressed, it silences the alarm for 10min (if alarming due to heat), 4 minutes (if alarming due to <150ppm CO) |
| Visual indicators | Green LED – Power supply Yellow LED – Fault, EOL Red LED – memory, pre-alarm or alarm (if coincides with horn sounding) |
| AudioLINK | Enabled |

Technical Specifications

| | |
|------------------------------|--|
| Operational Life | 10 years |
| Interconnection | Up to 12 units can be interconnected via a hardwired or wireless system (using optional Ei3000MRF SmartLINK module) |
| Fixings | Supplied with Easi-fit anti-tamper mounting plate with integral terminal block and wiring cover, includes screws and wall plugs |
| Operating Temperature | Normal: 0°C to +35°C (Storage: 0°C to +35°C) * |
| Humidity Range | 15% to 95% RH (non-condensing) |
| Plastic Material | UL94V-0 flame retardant rated |
| Dimensions | Ei3028: Product: - Ø150mm x 66mm Package - 155mm x 155mm x 70mm Ei3018: Product: - Ø150mm x 63mm Package - 155mm x 155mm x 65mm |
| Weight | 350g (including packaging) |
| Warranty | 5 year (limited) |
| Approvals | KM86596 KM83678 EN50291-1:2010+A1:2012, BS5446-2:2003 |

* Temperature and Humidity conditions are for normal operation and storage. Units will function outside these ranges as required by the specific product Standards. Extended exposure to conditions outside these ranges can reduce product life. For advice on prolonged operation outside these ranges consult the manufacturer.

2

Installation

2.1 Important Safety Instructions



Mains operated Alarms should be installed and interconnected by a qualified electrician in accordance with the local appropriate Regulations for Electrical Installations. Failure to install this Alarm correctly may expose the user to shock or fire hazards and damage the product.

The Alarm is designed to be permanently mounted, using its own built-in terminal block to connect it to the mains. The mounting plate can be screwed directly to the ceiling. Alternatively, it can be screwed to a standard junction box (BS 4662 single gang accessory box). It requires a typical current of 3mA. The Alarm must not be exposed to dripping or splashing. There are important markings on the underside of the Alarm.



It is a requirement that CO Alarms must be installed by a competent person.



Alternative Energy Sources - (Wind, Solar, UPS etc.)

This product is designed to be connected to a Pure or True Sine Wave 230V AC supply. If connecting to a power source that utilises an inverter, e.g. PV solar panel, the Total Harmonic Distortion (THD) must be less than 5%. If in doubt please check with the manufacturer of the inverter. This also applies to battery powered UPS (Uninterruptible Power Supply) inverters.



Light Dimmer Circuits - The Alarms must not be powered from a light dimmer circuit.



Do not install Alarms in new or renovated buildings until all work is completed.



The Alarm must **not** be connected when the house wiring insulation is being checked with high voltages. i.e. Do **not** use a high voltage insulation tester on the Alarm.



The Alarm must be continuously powered 24 hours a day so it is important that it is not on a circuit that can be turned off by a switch.



(UK) BS 5839-6: 2013 gives the following recommendations regarding the mains supply to be used in a Grade D system. The power supply for the Alarms should be derived from the public electricity supply to the dwelling. The mains supply to the Alarms should take the form of either: (a) an independent circuit at the dwelling's main distribution board, in which case no other electrical equipment should be connected to this circuit (other than a dedicated monitoring device installed to indicate failure of the mains supply to the Alarms); or (b) a separately electrically protected, regularly used local lighting circuit. Alarms should be connected on a single final circuit, unless the means of interconnection is by radio signals (e.g. RadioLINK). (See BS 5839-6: 2013 for further information)

(IRE) Please refer to ET101: 2008: National Rules for Electrical Installations.

2.2 Where to locate the Alarm

The Ei3028 Heat and CO Alarm can be installed for dual protection against Fire and Carbon Monoxide anywhere a Heat Alarm is recommended/specified. It is ideal for kitchens, garages, boiler houses and other areas where there are normally high levels of fumes, smoke or dust i.e. places where Smoke Alarms cannot be installed without the risk of excessive nuisance alarms and where often a fuel burning appliance is present.

A Carbon Monoxide Alarm like the Ei3018 should be installed in:

- Every room containing a fuel burning appliance
- Remote rooms where occupants spend a considerable amount of time
- Every bedroom

However, if the number of CO Alarms is limited, the following points should be considered when deciding where best to fit the alarm(s).

- If there is an appliance in a room where people sleep, place a CO Alarm in this room
- Locate a CO Alarm in a room containing a flueless or open-flued appliance
- Locate a CO Alarm in a room where the occupant(s) spend most of their time (e.g. living room)
- In a bedsit, the CO Alarm should be placed as far away from the cooking appliance as possible, but near to where the occupant sleeps
- If the appliance is in a room not normally used (such as a boiler room) the CO Alarm should be placed just outside the room so that the alarm will be heard more easily.

2.3 Which Alarm In what room?

| Location | Ei3028 Heat and CO Alarm | Ei3018 CO Alarm |
|---|--------------------------------|-----------------------|
| Kitchens with Fuel Burning appliance | ✓ | |
| Garages with Fuel Burning appliance | ✓ | |
| Boiler houses | ✓ | |
| Areas with high levels of fumes, smoke or dust and risk of CO | ✓ | |
| Any other rooms with Fuel Burning appliance | | ✓ |
| Any other rooms with risk of CO poisoning | | ✓ |

2.4 Where in the room?

The locations must comply with applicable building regulations

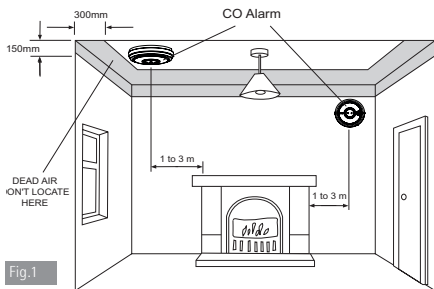

In a room **WITH** a fuel burning appliance

- The CO alarm should be a horizontal distance of between 1m and 3m from the potential CO source

- If there is a partition in the room, the CO Alarm should be located on the same side of the partition as the potential source.

Ceiling Mounted

If it is mounted on the ceiling it should be at least 300mm from any wall or light fitting.

In rooms with sloped ceilings, the CO Alarm should be located at the high side of the room.

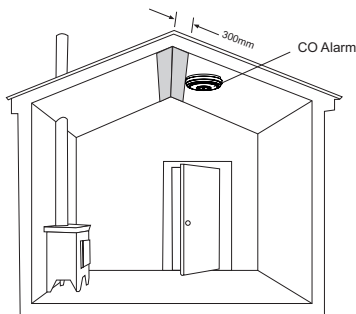

Wall Mounting (Ei3018 only)

If ceiling mounting is impractical, **ONLY** the Ei3018 CO Alarm can be mounted on a wall. It should be located at a height greater than the height of any door or window but still be at least 150mm from the ceiling

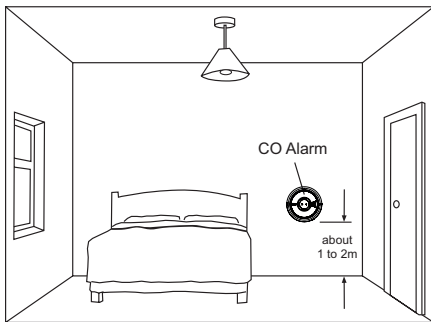

Fig.3

In a room **WITHOUT** a fuel burning appliance

Wall mounted (Ei3018 only)

- At breather level (approx.. 1 to 2m above the floor) so it is possible to view the three light indicators.

WARNING: The Ei3028 Heat and Carbon Monoxide Alarm is not suitable for wall mounting

2.5 Unsuitable locations

Do not place the Alarm in any of the following areas:

- In a bathroom or other areas where the Alarm may be exposed to water splashes, dripping or condensation (e.g. above an electric kettle).
- In very high or awkward areas where it may be difficult to reach the Alarm (for testing, hushing etc.) or fit the screwdriver to release the Alarm from its mounting plate.
- Next to or directly above heaters or air conditioning vents, doors, windows, extractor fans or anywhere that it would be affected by draughts.
- Directly above a sink or cooker.
- In an area where the temperature could drop below -10°C or rise above 40°C .
- Outside the building.

- In an enclosed space (e.g. in or below a cupboard).
- In a damp or humid area.
- Where it would be obstructed, e.g. by curtains or furniture.
- Where dirt or dust could block the sensor.
- Near paint, thinners, solvent fumes or air fresheners.
- Locate the Alarm at least 1.5m and route wiring at least 1m away from fluorescent light fittings as electrical "noise" and/or flickering may affect the Alarm. Do not wire into the same circuit as fluorescent lights or dimmers.
- Locate the Alarm at least 1m from dimmer controlled lights and wiring as some dimmers can cause interference.

2.6 Mounting and wiring

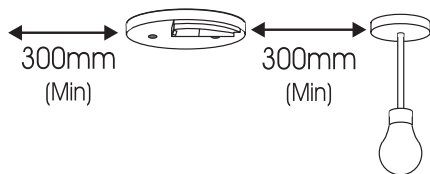

1. Select a location complying with the advice in previous sections.

2. Disconnect the AC mains supply from the circuit that is going to be used.

Foam ceiling gasket
(must be in place)

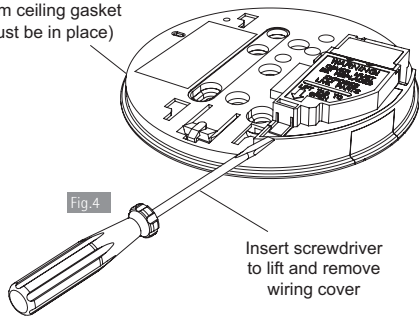

3. Lift off the wiring cover as shown in Figure 4.

The wiring must be connected to the terminal block on the mounting plate as follows:

L: Live - connect to the house wires coloured brown or marked L.

N: Neutral - connect to the house wires coloured blue or marked N.

IC: Interconnect - see figures 5 and 6 and further information in Section 2.6.

Note: *Wiring must be installed in compliance with local regulations.*

Warning: Mixing the Live and Neutral connections when interconnecting Alarms may damage all the Alarms - ensure that the same colours are used throughout the premises for Live, Neutral and Interconnect wires.

We strongly recommend that you check for the following **before connecting the Alarm:**

- check for Live and Neutral using a two probe tester.
- check for Live using a neon tester.
- check that the Interconnect wire is NOT connected to Live, Neutral or Earth. **Do not use an Earth wire for the Interconnect line.**

Note: The Alarm does not need to be earthed. However the terminal marked  is provided for the convenience of the installer so that any copper Earth wire or cable coloured green and yellow, can be safely terminated.

To interconnect Alarms connect all the IC terminals together as shown in Figure 9 (see "Interconnecting Alarms" section).

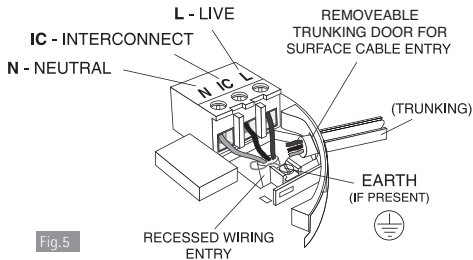

Fig.5

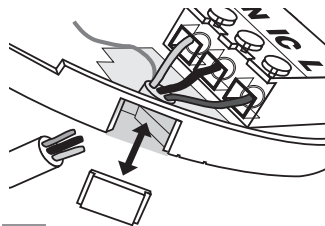

Fig.6

4. If the mains wires are recessed, bring the wires through the rear hole in the mounting plate as shown in Figure 5.

If the mains wires are being brought along the surface:

(a) position the mounting plate so the cable trunking is as shown in Figure 5.

(b) the mounting plate has a removable section, take it out to interface directly with 25mm trunking as shown in Figure 6. If interfacing to 16mm trunking carefully cut around the marked section, leaving the top intact and replace the section. (If you are not using surface wiring, the removable section must be left in place for electrical safety reasons).

There are two other positions which are also suitable for the surface wiring to enter (and exit) the Alarm, one next to the removable section and another directly opposite.

5. Carefully align the mounting plate and screw into place. Connect the wires to the terminal block. With recessed wiring, ensure the rear gasket seals around the edge of the hole in the ceiling or wall. This is to prevent air draughts affecting the smoke/heat entering the Alarm. If the hole is too large or the Alarm does not seal it, it should be sealed with silicone rubber or equivalent.

Fig.7

Slide on the Alarm

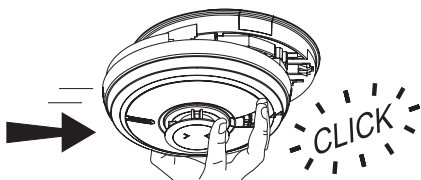
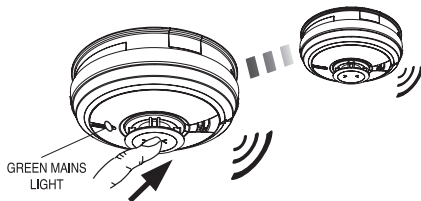

Fig.8

Test Alarms



6. Replace the wiring cover and carefully line up the Alarm on the base and slide on (see Figure 7).
7. Connect the mains power to the Alarm circuit. Check the green light on the front of the Alarm is on.
8. Press and hold the test/hush button for 10 seconds (see Figure 8). The horn will sound. Check that any interconnected Alarms also sound within this period. The test button sounds the local horn and on release this horn stops immediately, and all the interconnected Alarms can then be heard in the distance as they will continue to sound for a further 3 seconds.
9. Attach the 'fuse board label' provided on or near the distribution board and write in date installed and the number of Alarms on the circuit.
10. Ensure the Alarm operates correctly - see **TESTING and MAINTAINING YOUR ALARM** section.

2.7 Interconnecting Alarms

With interconnected Alarms, when one device detects Fire or CO all units will alarm. All horns will sound but only units detecting the emergency event will be flashing their red LED alarm indicator.

Heat Alarms should **always be interconnected** to Smoke or Multi-Sensor Fire Alarms to ensure early warning.

Note: A maximum of 12 Fire / Smoke / Heat / CO Alarms and accessory devices can be interconnected in an Ei Electronics Alarm system. (Any Ei3000 series Alarm can also be interconnected to an Ei2110e, Ei160e and Ei140RC Series).

If you wish to connect more than 12 alarms, contact your local helpline.



WARNING: Do not connect these Alarms to any other type of Ei Alarm (apart from those listed above) or to any other model produced by another manufacturer. Doing so may damage the Alarms and could result in a shock or fire hazard.

Systems using more than 3 or 4 Alarms must be very carefully planned to ensure nuisance alarms are not excessive. e.g. from cooking fumes or steam. The following is suggested:

- In an RF system an Ei Electronics Control Switch (Ei450) should be incorporated and be readily accessible to all occupants so that the source of an alarm can be quickly identified. This is especially important when both Fire and CO Alarms are used in the same system as the occupant will need to open all windows and doors if it is a CO incident but do the opposite to slow down a fire.
- All Alarms must be cleaned and maintained regularly.
- A qualified person must be on call to quickly remove any nuisance Alarms (i.e. Alarm with red LED alarm indicator flashing rapidly) which are causing all the other Alarms to sound.

Make electrical connections as shown in Figure 9.

Wiring must be installed in compliance with local regulations.

In the UK it is recommended that the following coloured cores are used (for example with triple flat 6243YH cable).

230V supply : Brown

Neutral Grey : sleeved blue at terminations

Interconnect : Black

In the other countries consult the local regulations as they are different from the UK regulations.

Fig.9

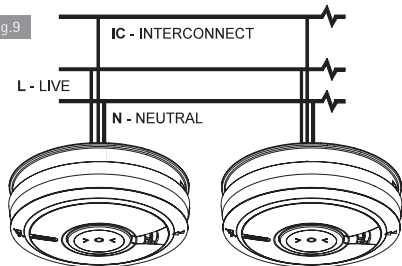

The interconnect wire (minimum 0.75mm² cable) must be treated as if it was Live. It should be insulated and sheathed.

A maximum of 250 metres of wire can be used (maximum resistance between detectors 50 Ohms). Alarms should be interconnected only within the confines of a single family living unit. If they are connected between different units, there may be excessive nuisance alarms. Everybody may not be aware that they are being tested or that it is a nuisance alarm caused by cooking etc.

The Alarm can also be RF interconnected to other RF Alarms and devices by installing an Ei3000MRF SmartLINK Module. See the User manual for the Ei3000MRF for further details on RF interconnection. It is also equipped to work in a hybrid system (combination of hard-wired and RF interconnected Alarms and devices).

Please note in a hybrid system containing CO / Heat / Fire / Smoke Alarms we recommend using an Ei3000 Series Alarm as the hybrid link to the RF section of the system.

Ensure the Alarms operate correctly - see **TESTING YOUR ALARM** in the user section.

2.8 Removing the Alarm

*** Disconnect mains before removal ***

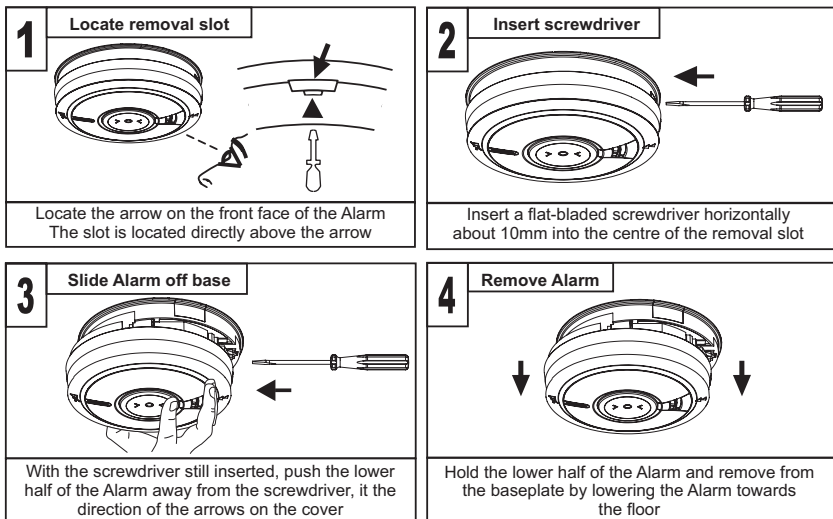

User Guide

3

What is Carbon Monoxide?

Many people are killed each year, and many more suffer ill health from Carbon Monoxide (CO) poisoning. CO is an invisible, odourless, tasteless and extremely toxic gas. It is produced by appliances and vehicles burning fuels, such as coal, oil, natural/bottled gas, paraffin, wood, petrol, diesel, charcoal etc. CO is absorbed by red blood cells in the lungs in preference to oxygen - this results in rapid damage to the heart and brain from oxygen starvation.

High levels of CO in a house can be caused by:

- Incorrectly or poorly installed fuel-burning appliances.
- Blocked or cracked chimneys/flues.
- Blocked vents or draught-proofing which makes areas with fuel burning appliances or fireplaces airtight.
- Engines of cars, lawnmowers etc. left running in confined spaces.
- Portable paraffin or gas heaters in badly ventilated rooms.

Most people know that high levels of CO are harmful, however the period of exposure is also important.

A low level for a long period (e.g. 150 ppm for 90 minutes) can cause the same symptoms (a slight headache) as a high level of CO for a short period (e.g. 350 ppm CO for 30 minutes). Table A shows how exposure to different concentrations of CO generally affects people.

Many cases of reported Carbon Monoxide poisoning indicate that while victims are aware they are not well, they become so disorientated they are unable to save themselves by either leaving the building or calling for assistance. Young children and household pets may be the first affected.

3.1 Symptoms of CO poisoning

| Table A | |
|---------------------------------------|--|
| Concentration of CO in Air ppm | Inhalation Time (approx) and Symptoms Developed |
| 35 | The maximum allowable concentration for continuous exposure in any 8 hour period according to OSHA *. |
| 150 | Slight headache after 1.5 hours. |
| 200 | Slight headache, fatigue, dizziness, nausea after 2-3 hours. |
| 400 | Frontal headaches within 1-2 hours, life threatening after 3 hours, also maximum parts per million in flue gas (on an air free basis) according to US Environmental Protection Agency. |
| 800 | Dizziness, nausea and convulsions within 45 minutes. Unconsciousness within 2 hours. Death within 2-3 hours. |
| 1,600 | Headache, dizziness and nausea within 20 minutes. Death within 1 hour. |
| 3,200 | Headache, dizziness and nausea within 5-10 minutes. Death within 25-30 minutes. |
| 6,400 | Headache, dizziness and nausea within 1-2 minutes. Death within 10-15 minutes. |
| 12,800 | Death within 1-3 minutes. |

▲ ppm = parts per million

*OSHA Occupational Safety and Health Association

3.2 How to protect your family against CO

Follow these guidelines to reduce the risk of Carbon Monoxide poisoning.

(1) Know and look out for tell-tale signs that Carbon Monoxide may be present.

These include:

- The CO Alarm warning of abnormal levels.
 - Staining, sooting or discolouration on or around appliances.
 - A pilot light frequently going out.
 - A strange smell when an appliance is operating.
 - A naked gas flame which is yellow or orange, instead of the normal blue.
 - Family members (including pets) exhibiting the "flu-like" symptoms of CO poisoning described above. If any of these signs are present get the appliance checked out by an expert before further use. If family members are ill get medical help.
- (2) Choose all appliances and vehicles which burn fossil fuels such as coal, oil, natural/bottled gas, paraffin, wood, petrol, diesel, charcoal etc. with care and have them professionally installed and regularly maintained.
- (3) These appliances must "breathe in" air to burn the fuel properly. Know where the air comes from and ensure vents/air bricks etc. remain unobstructed (particularly after building work).
- (4) The appliances must also "breathe out" the waste gases (including the CO) – usually through a flue or chimney. Ensure chimneys and flues are not blocked or leaking, and get them checked every year. Check for excessive rust or cracks on appliances and pipe work.
- (5) Never leave your car, motor bike or lawnmower engine running in the garage with the garage door closed. Never leave the door from the house to the garage open if the car is running.
- (6) Never adjust your own gas pilot lights.

- (7) Never use a gas cooker or a barbecue for home heating.
- (8) Children should be warned of the dangers of CO poisoning and instructed never to touch, or interfere with the CO Alarm. Do not allow small children to press the test/hush button as they could be subjected to excessive noise when the CO Alarm sounds.
- (9) Leaving windows or doors slightly open (even a few inches) will significantly reduce the risk of high levels of CO occurring. The high levels of draught-proofing in modern houses reduces ventilation and can allow dangerous gases to build up.
- (10) Install CO Alarms in all the areas recommended in this booklet.
- (11) Recognise that CO poisoning may be the cause when family members suffer from "flu-like" symptoms when at home but feel better when they are away for extended periods.













IMPORTANT: The Installation of a CO Alarm should not be used as a substitute for proper installation, use and maintenance of fuel burning appliances including appropriate ventilation and exhaust systems.

3.3 How does your Alarm work?



When the Alarm detects Fire and/or abnormal levels of CO, the red LED starts to flash and the horn will sound.

The standard Ei Electronics Fire alarm pattern is a continuous rapid pulsing sound type, while the distinctive Carbon Monoxide alarm pattern is a repeating cycle of 3 slower sound pulses followed by a pause. On the Ei3028, the LED display will indicate if Fire or CO is detected.

The flash rate of the red LED indicator is dependent on the alarm event type, and in the case of CO, on the level detected. Table B shows how the CO sensor reacts to different levels of CO gas and exposure time.

| Table B – Alarm indicators | | | |
|---|--|--|--|
| Event type | Red LED | LED icon Fire or CO (Ei3028 only) | Alarm |
| FIRE (Ei3028 only) |  every 5 sec |  Flashing |  |
| CO Gas Level ≥ 50ppm |  every 4 sec x 2 |  Flashing |  within 60-90 mins |
| CO Gas Level ≥ 100ppm |  every 4 sec x 3 |  Flashing |  within 10-40 mins |
| CO Gas Level ≥ 300ppm |  every 4 sec x 4 |  Flashing |  within 3 mins |
| Alarm triggered by interconnected Alarm | — | — |  |

Note: The CO Alarm may sound if cigarette smoke is blown into it, or aerosols are released nearby

















 = LED on solid  = LED flashing

The Alarm will also trigger all interconnected Alarms to sound, so that the occupier is alerted even if they are in a different room to the emergency event.

Note: In an interconnected system, the Alarm may also be triggered to sound by another Alarm. In this case, the Alarm will sound but will not flash its red LED alarm indicator. This means that while the Alarm is sounding, it is not the unit actually sensing the alarm event. If you have an Ei1529RC or Ei450 Remote Control installed, press the locate switch to leave just the Alarm that has triggered the system sounding and identify the source and type of the alarm.

- When fire is detected, you should evacuate the residence, closing all doors and windows along the way.
- If CO is detected, you should open all windows and doors (if safe to do so), and then evacuate.

The Alarm memory is an important feature of the Alarm where even if the house is unoccupied during an alarm condition it warns the homeowner that the Alarm has previously detected Fire or CO gas and been in alarm. Table C outlines the indicators that are displayed in the memory mode.

| Table C - Memory indicators | | | | |
|-----------------------------|---|--|-------------------------------------|---|
| Event type | Red LED | | LED icon - Fire or CO (Ei3028 only) | |
| | 1 st 24h | > 24h on test button | 1 st 24h | > 24h on test button |
| FIRE |  x 2 every 48 secs |  x 2 every 8 secs | — | Flashing  FIRE  |
| CO Gas Level ≥ 50ppm |  x 4 every 48 secs |  x 4 every 8 secs | — | Flashing  CO  |
| CO Gas Level ≥ 100ppm |  x 6 every 48 secs |  x 6 every 8 secs | — | Flashing  CO  |
| CO Gas Level ≥ 300ppm |  x 8 every 48 secs |  x 8 every 8 secs | — | Flashing  CO  |

Hush feature

The Alarm has a combined Test/Hush Button. When the alarm sounds, pressing the Test / Hush button will immediately silence the alarm for a period of 10 minutes, if due to heat, or 4 minutes, if due to CO (the red light will continue to flash). After that period of time the Alarm will reset to normal functionality. In the case of CO, the Alarm can only be silenced once during a CO incident and only if the CO level detected is < 150ppm.

Note: To stop all alarms on an interconnected system, press the Test/Hush Button on the Alarm sensing heat, CO or smoke (i.e. the one with the red LED alarm indicator flashing rapidly) to silence all Alarms. Pressing the Test/Hush Button on any other Alarm will not cancel the source Alarm. Alternatively, in an interconnected system fitted with a Control switch, you can identify the source Alarm by pressing the LOCATE switch. When all Alarms are sounding, it will silence all Alarms apart from the Alarm that is sensing fire / smoke / heat / CO.

4

Testing

4.1 Testing and maintaining your Alarm

Frequent testing of all your Alarms is a requirement to ensure they are functioning correctly. Guidelines and best practices for testing are as follows:

1. After the system is installed.
2. Once monthly thereafter.
3. After prolonged absence from the dwelling (e.g. after holiday period).
4. After repair or servicing of any of the systems elements or household electrical works.

Inspecting and Testing procedure

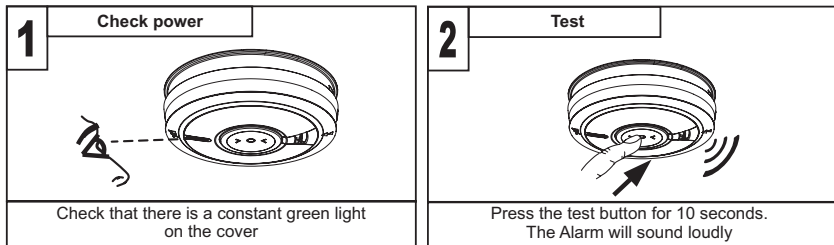

- (i) Check that the **green LED power indicator** is on continuously.
- (ii) Check also that there are no faults i.e. NO green, yellow or red LED flashing (if this is the case please see indicator summary table)

(iii) Press the **test button** for up to 10 seconds and ensure that the Alarm sounds. This tests the sensor, electronics and sounder are working. The Alarm will stop when the button is released. Pressing the test button simulates the effect of smoke and/or heat and therefore is the best way to ensure the Alarm is operating correctly. (Refer to indicator summary table if you see Red or Yellow LED flashes).

(iv) **Interconnected Alarms only** - Test the first unit by pressing the test button for 10 seconds. All the Alarms should sound within 10 seconds of the first horn sounding. After releasing the test button, the local horn will stop sounding immediately and the interconnected Alarms will be heard sounding in the distance for a further 3-4 seconds. This feature gives an audible verification that the interconnection is OK. Check all the other Alarms in the same way.

(v) Check the functioning of the mains battery back-up directly after installation and then at least yearly as follows:

- Turn off the mains power at the distribution board and check that the green indicator light is now flashing (1 flash every 48 seconds) to indicate the Alarm is on backup battery power.
- Press the Test/Hush button for up to 10 seconds and ensure the horn sounds loudly.
- Monitor the Alarm over a 3 minute period for any fault chirps and or yellow LED fault indicator flashes (Refer to "**Fault Modes**" table on what to do if this occurs)
- Turn the mains supply at the distribution board back on.

Switching off Mains for long periods

If the premises are regularly being left without mains power for long periods the Alarms should be removed from their mounting plates and the Ei3000MRF modules (if fitted) should be removed to prevent the batteries becoming fully depleted. (This is sometimes done with holiday homes which are only occupied in the summer).

The Ei3000MRF modules (if required) must be re-fitted to the Alarms and the Alarms must be re-attached to the mounting plates when the premises are re-occupied. Ensure to match the original RF module back to the same Alarm head.

(Long term storage (over 1 year) can damage the batteries such that they will not recharge when the units are re-connected to the mains supply).

WARNING: DO NOT TEST WITH FLAME

This can set fire to the Alarm and damage the house. We also do not recommend testing with heat as the results can be misleading unless special apparatus is used.

4.2 Cleaning your Alarm

Clean your Alarm regularly. In dusty areas it may be necessary to clean the Alarm more frequently.

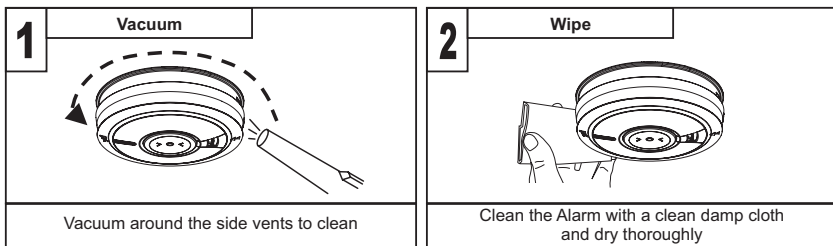

Use the narrow nozzle attachment of your vacuum cleaner to remove dust, insects and cobwebs from the sides and cover slots where the airflow enters. Clean the outside cover by occasionally wiping with a clean damp cloth then dry thoroughly with a lint free cloth. Do not use any cleaning agents, bleaches, detergents or polishes, including those in aerosol cans.

WARNING: Do not paint your Alarm.

Other than the cleaning described above, no other customer servicing of this product is required. Servicing or repairs, when needed, must be performed by the manufacturer.

All Alarms are prone to dust and insect ingress, which can cause false alarms or failure to alarm. In certain circumstances, even with regular cleaning, contamination can build up in the sensor causing the Alarm to sound or fail. Contamination is beyond our control, it is totally unpredictable and is considered normal wear and tear. For this reason, contamination is not covered by the guarantee.

5

What to do in
case of FIRE?

(i). Check room doors for heat or smoke. Do not open a hot door. Use an alternate escape route. Close all doors behind you as you leave.



(ii). If smoke is heavy, crawl out, staying close to floor. Take short breaths, if possible, through a wet cloth or hold your breath. More people die from smoke inhalation than from flames.



(iii). Get out as fast as you can. Do not stop for packing. Have a prearranged meeting place outside for all family members. Check everybody is there.



(iv). Call the Fire Brigade immediately on a mobile phone or from a neighbour's house. Make sure to call the Brigade for all fires no matter how small - fires can suddenly spread. Also call the Brigade even if the alarm is automatically transmitted to a remote manned centre - the link may have failed.



(v). NEVER re-enter a burning house.



6

What to do in case
your Alarm detects
Carbon Monoxide?

- (i) Open the doors and windows to ventilate the area (if it is safe to do so).
- (ii) Turn off all fuel appliances where possible.
- (iii) Evacuate the property leaving the doors and windows open.
- (iv) Get medical help immediately for anyone suffering the effects of Carbon Monoxide poisoning (headache, nausea), and advise that Carbon Monoxide poisoning is suspected.
- (v) Ring your gas or other fuel supplier on their emergency number. Keep the number in a prominent place.
- (vi) Do not re-enter the property until the alarm has stopped. (If the Alarm has been silenced by pressing the Test/Hush button, wait at least 5 minutes. The Alarm will then check that the CO has cleared).
- (vii) Do not use the fuel appliances again until they have been checked by an expert. In the case of gas appliances this must be a Registered Gas Installer.

The alarm will stop once the CO has cleared.

Pressing the Test/Hush button will silence the alarm immediately for 4min if <150ppm CO. If CO is still present after 4min, the red LED indicator and horn will turn on again.

Note: When ventilation is provided by leaving the window and doors open, the CO build up may have dissipated by the time help arrives and the Alarm may have stopped sounding. Although your problem may appear temporarily solved, it is crucial that the source of the CO is determined and appropriate repairs made.

NEVER IGNORE THE ALARM!

7

Troubleshooting and Indicator summary tables

| | |
|--|--|
| <p>Your Alarm does not sound when you press the Test button</p> | <ul style="list-style-type: none"> • Check the Alarm is secured correctly on the mounting plate. • Wait 15 seconds after connecting the power before button testing. • Hold button down firmly for at least 10 seconds. • If the horn does not sound, then your Alarm must be returned for repair or replacement - see "GETTING YOUR ALARM SERVICED" section |
| <p>Your Alarm sounds for no apparent reason</p> | <ul style="list-style-type: none"> • Follow the detailed instructions in section 5 and/or section 6 regarding the alarm condition. • Locate the Alarm that sounds and has a flashing red LED. • Identify the alarm type – Fire or CO (Ei3028) • For Fire: <ul style="list-style-type: none"> - If you have thoroughly investigated and are sure that it is just a nuisance alarm, simply press the Test/Hush button briefly to silence the Alarm and any interconnected devices for 10 minutes. When the Alarm is in 'Hush' mode the red LED will continue to flash while it detects the presence of heat. The Alarm will reset to normal functionality at the end of the 10 minute. If additional silenced time is required, simply push the Test/Hush Button again. - If you experience frequent nuisance/false alarms, it may be necessary to re-locate the Alarm away from the source of the fumes or if it continues to sound without smoke or heat being present and cleaning the Alarm does not solve the problem, it needs to be replaced |

| | |
|--|--|
| | <ul style="list-style-type: none"> • For CO: <ul style="list-style-type: none"> - Ensure there are no fuel burning appliances in the vicinity which could be leaking CO gas (e.g. even from next door). - Ensure there are no fumes or aerosols in the area (e.g. paint, thinners, hair spray, chemical cleaners, aerosol sprays, damp proofing done with and aqueous emulsion such as Aminofunctional siloxane and Alkylalkoxysilane) which can cause false CO alarms. - Ensure there is no outdoor source of CO in the vicinity (e.g. a car with engine running, heavy traffic, heavy air pollution, barbecue fumes etc). - Ensure there is no source of hydrogen such as batteries being charged (e.g. on boats or in Uninterruptable Power Supplies (UPS)), as this can lead to false CO alarms. - Ensure there is not excessive smoke or fumes from devices such as Egyptian shisha, hookah or hubbly bubbly pipes, especially those that use coal or charcoal to heat the tobacco. - Press the Test/Hush button to silence the Alarm for 4 minutes. - If the CO Alarm continues to sound it is possibly defective and should be replaced |
| <p>Interconnected Alarms do not all sound</p> | <ul style="list-style-type: none"> • Hold test button for 10 seconds after the first alarm has sounded to ensure signal is transmitted to all units. • If this is not the case and you have a hardwired interconnection, we recommend you consult a qualified electrician. • If the Alarm is fitted with an RF module for wireless interconnection, check that all Alarms in the RadioliNK system are powered and are house-coded correctly. (see the Ei3000MRF RadioliNK+ module manual) |

| | |
|---|---|
| Pressing the Test/Hush button does not silence the Alarm | Always make sure that you are pressing the Test/Hush button on the Alarm that sounds with the red LED flashing. |
| Your Alarm chirps/beeps/ flashes | <p>In standby mode, the Alarm does not sound, beep, chirp or flash. The only light on is the green power LED.</p> <p>The Alarm automatically monitors the battery, sensor and electronics periodically to ensure that all are satisfactory. If a fault has been found, the alarm alerts the occupier to this via short chirps from its sounder and yellow LED fault indicator flashes every 48 seconds. The alarm will also indicate any faults when the test button is pressed.</p> <p>See indicator summary table on the next pages</p> |

| Normal Operation | | | | | | |
|---|-------------------|--------------------|--------------------|-------|------------------------------------|----------------------|
| Mode / Action | Green LED (Power) | Yellow LED (Fault) | Red LED (Alarm) | Alarm | Icon Display FIRE/CO (Ei3028 only) | Notes |
| Power up | | | | — | 1 Flash & FIRE & CO | |
| Standby | | — | — | — | — | |
| Testing (pressing and holding Test button) | * | — | — | | Flashing | |
| In Alarm | | | | | | |
| Detecting Fire | | — | as per Table B | | Flashing FIRE | Fire sound pattern |
| Detecting CO | | — | | | Flashing CO | CO sound pattern |
| Activated via Interconnect | | — | — | | — | |
| Pressing Silence Button on Alarm detecting fire | | — | as per Table B | | Flashing FIRE | |
| Pressing Silence Button on Alarm detecting CO | | — | | | Flashing CO | once per alarm event |

* With the test button held the green LED will flicker/pulse every second

= LED on solid = LED flashing

The Alarm memory is an important feature of the Alarm where even if the house is unoccupied during an alarm condition it warns the homeowner that the Alarm has previously detected Fire or CO gas and been in alarm. It is particularly useful in the case of CO leakages which may have occurred when the owner is away from the property - for example, CO leaking from a faulty boiler operating on a timer. The memory feature also helps identify the unit and event type which has previously triggered an entire alarm system, which can also very helpful after the entire alarm system has gone into alarm and then stopped, for no obvious reason.

Once the source Alarm has been identified, appropriate action can be taken e.g. In the case of a CO alarm event in memory, investigate any potential sources of CO leaks, or in the case of a fire alarm event in memory, investigate the cause of nuisance / false alarms by ensuring kitchen or bathroom doors are kept closed to prevent very hot air or steam from cookers / showers reaching the heat sensor on the Alarm, locate the Alarm further away from the source of steam or condensation, replace the Alarm if it is thought to be defective or remove the unit in the short term.

The memory feature has two operation modes:

















- memory indication for 24 hour period after alarm.
- memory recall on demand

24-hour memory indicators: For 24 hours after alarming, the red LED alarm indicator will flash at different rates every 48 seconds (approx) depending on the alarm event type (Fire or CO) and in the case of CO, on the level detected - see Table C.















Memory recall on demand: To review the memory status at any time, press and hold the test button, the red LED alarm indicator will flash in accordance to Table C to convey the alarm event in memory, if any.

Reset Memory: Hold down the test button for at least 20 seconds. Cover the horn with a cloth to muffle the alarm during this time. Clearing of the memory is indicated by a 1-second-long flash of the red LED alarm indicator. Please note that the alarm memory will also be reset if the Alarm is removed from its mounting plate (switched off).

Memory mode

| What you hear / see | | | | | What type of alarm event has occurred |
|---|---|---------------------------------------|--|------------------------|---------------------------------------|
| Red LED | | Icon Display FIRE/CO (Ei3028 only) | | | |
| 0-24h | >24h on button test | 0-24h | >24h on button test | | |
|  every 48 sec x2 |  x2 every 8 secs | — |  Flashing  FIRE | Fire | |
|  every 48 sec x4 |  x4 every 8 secs | — |  Flashing  CO | CO Gas Level 50ppm | |
|  every 48 sec x6 |  x6 every 8 secs | — |  Flashing  CO | CO Gas Level 100ppm | |
|  every 48 sec x8 |  x8 every 8 secs | — |  Flashing  CO | CO Gas Level 300ppm | |

Alarm memory can be erased by pressing & holding the test button for >20 seconds after which a 1-second-long flash of the red LED alarm indicator indicates memory cleared

| Fault modes and Memory indicator | | | | | |
|--|--|---|--|---|---|
| What you hear / see | | | | What it means | What to do |
| Green LED ¹ (power) | Yellow LED ² (fault) | Red LED (alarm) | Chirps | | |
|  every 48 sec x1 | — | — | — | AC mains off | Reconnect AC mains power |
| — |  every 48 sec x1 | — |  | AC mains off Low battery backup | Reconnect AC mains power |
|  |  every 48 sec x1 | — |  | Low battery backup | Replace Alarm |
|  |  every 48 sec x2 | — |  x2 | Sensor fault | Replace Alarm |
|  |  every 48 sec x3 | — |  x3 | End of Life | Replace Alarm |
|  | Flashes as per fault type | — | — | Fault chirps have been silenced. Rate of the yellow LED flashing indicates fault type | If required chirping can be silenced again by pressing Silence button |
|  | — |  when pressing Test button | — | There has been an alarm in your absence | Check Alarm memory section |

1 ON when AC mains power is switched on, flashes every 48s when on backup battery, OFF when both AC mains and backup battery are off.

2 If you are unsure of the amount of flashes of the Yellow LED you can at any time while a fault condition exists, press the Test button. The relevant number of flashes will then be 8s apart.

Note: Fault chirps can be silenced by pressing the Test/Hush button.

The Alarm can communicate its status and history through various Led flashes and chirps/beeps. However, a more comprehensive report of all such events is available through the AudioLINK download via the App.

Low Battery Backup Fault

If the battery backup supply is depleted, the sounder will give one short chirp with one yellow LED fault indicator flash every 48 seconds. In this case check that the green LED power indicator is on continuously. If it is off, or flashing every 48 seconds, the Alarm is not receiving 230V AC mains power and is being powered by the battery backup. The chirp every 48 seconds indicates that the battery is depleted. The battery is not replaceable. Check fuses, circuit breakers and wiring to determine the cause of the interruption to the mains power. If in doubt, contact a qualified electrician. Once mains power is reinstated, the chirps should cease within 2 hours as the battery charges up. Fully charged, the battery will provide up to 4 months back-up without mains power. If the chirping persists for over 2 hours with the green light on, there may be some other problem with the Alarm. The Alarm must be returned for repair or replacement - see **GETTING YOUR ALARM SERVICED** section.

Sensor Fault

The Alarm regularly checks the CO sensor and/or thermistor heat sensor for correct operation. If the Alarm has found a fault with the sensor, it will give 2 short chirps with 2 yellow LED flashes every 48 seconds. In this case, the Alarm must be returned for repair or replacement - see **GETTING YOUR ALARM SERVICED** section.

End of Life

Once the Alarm passes its 10th year of installation, it will give 3 short chirps with 3 yellow LED flashes every 48 seconds to indicate it has reached its end of useful life.

The entire Alarm must be replaced (Also check the replace by date on the label on the side of the Alarm). Disconnect the mains first and replace the Alarm - see 'Removing the Alarm' section.

Temporarily Silencing the Fault chirps

If the test / hush button is pressed on an Alarm that is giving fault chirps and yellow LED fault indicator flashes, the Alarm will be silenced (Fault Hush mode) for a period of 12 hours. However, the Alarm will sound / function as normal within that period should it detect Fire (except if the fault detected is a sensor fault). The yellow LED fault indicator will continue to flash as before to indicate the fault is still present. This is a useful feature should the fault occur at night as it keeps the disturbance at a time when people in the building are trying to sleep to a minimum. The fault chirps would return 12 hours later, which perhaps may be a more suitable time to address the fault issue with the Alarm. In case of low backup battery voltage and end of life fault chirps, this can be repeated as required. A sensor fault condition can only be hushed once.

8

Important Safeguards

Limitations of Heat and CO Alarms

- Mains powered Alarms will not work if the mains power supply is off or disconnected and the backup battery is depleted.
- The Alarms may not be heard. The sound output is loud but it may not be heard behind a closed door or if it is too far away. Interconnecting Alarms greatly improves the probability that they will be heard. The Alarm may not wake up somebody who has taken alcohol or drugs. The alarm sound may be masked by other sounds such as T.V., stereo, traffic noise etc. This Alarm is not designed for people with impaired hearing.
- Heat Alarms will not detect fire if sufficient heat does not reach the Alarms. Heat may be prevented from reaching the Alarm if the fire is too far away, for example, if the fire is on another floor, behind a closed door, in a chimney, in a wall cavity, or if the prevailing air drafts carry the heat away. Interconnecting heat alarms with smoke alarms located throughout the house or premises will significantly improve the probability of early detection.
- The Heat Alarm may not detect every type of fire to give sufficient early warning.
- Carbon Monoxide must enter the CO Alarm for it to be detected. There may be Carbon Monoxide in other areas of the house (e.g. downstairs, in a closed room etc) but not in the vicinity of the CO Alarm. Doors, air draughts and obstructions can prevent the CO from reaching the Alarm. For these reasons we recommend CO Alarms are fitted both near and in bedrooms, particularly if bedroom doors are closed at night. Additionally, install in rooms where members of the household spend much of their time, and in rooms with potential sources of CO gas.
- The Alarms don't last indefinitely. The manufacturer recommends regular testing and replacement after, at most, 10 years, as a precaution.
- CO Alarms are not a substitute for life insurance. House-holders are responsible for their own insurance. The CO Alarm warns of increasing CO levels, but we do not guarantee that this will protect everyone from CO poisoning.

- CO Alarms are not suitable as early warning Smoke Alarms. Some fires produce Carbon Monoxide, but the response characteristics of these CO Alarms are such that they would not give sufficient warning of fire. Smoke Alarms must be fitted to give early warning of fire.
- This CO Alarm does not detect the presence of natural gas (methane), bottled gas (propane, butane) or other combustible gases. Fit combustion gas alarms to detect these.

WARNING: THIS CO ALARM IS DESIGNED TO PROTECT INDIVIDUALS FROM THE ACUTE EFFECTS OF CARBON MONOXIDE EXPOSURE. IT WILL NOT FULLY SAFEGUARD INDIVIDUALS WITH SPECIFIC MEDICAL CONDITIONS. IF IN DOUBT CONSULT A MEDICAL PRACTITIONER.

When a fire and/or CO Alarm system is installed, basic safety precautions should always be followed, including those listed below:

- Please read all instructions.
- Use the testing of the Alarm as a means to familiarise your family with the alarm sound. Rehearse emergency escape plans so everyone at home knows what to do in case the Alarm sounds. Further information can be obtained from your local fire prevention officer.
- To maintain sensitivity to Fire/CO, do not paint or cover the Alarm in any manner and; do not allow cobwebs, dust or grease to accumulate.
- If the Alarm has been damaged in any way or does not function properly, do not attempt a repair. Return the Alarm - see Section 9 '**SERVICE AND GUARANTEE**' section.
- This appliance is only intended for premises having a residential type environment.
- Fire/CO Alarms are not a substitute for insurance. The supplier or manufacturer is not your insurer.
- Do not dispose of your Alarm in a fire.

9

Service and Guarantee

9.1 Getting your Alarm serviced

If, within the guarantee period, your Alarm fails to work after you have carefully read all the instructions, checked the unit has been installed correctly, and is receiving AC power, then contact us.

If you are advised to return your Alarm, please ensure that the Alarm is placed in a padded box, not attached to the mounting plate (as the Alarm can give beeps or alarm if the Test/Hush button is pressed during shipping), with the proof of purchase and a note stating the nature of the fault.

9.2 Guarantee

Ei Electronics guarantees this Alarm for five years from the date of purchase against any defects that are due to faulty materials or workmanship. If this Alarm should become defective within the guarantee period, we shall at our discretion repair or replace the faulty unit.

This guarantee only applies to normal conditions of use and service, and does not include damage resulting from accident, neglect, misuse, unauthorised dismantling, or contamination howsoever caused. This guarantee excludes incidental and consequential damage.

This guarantee does not apply to any product that has been modified in any way by a third party or has been fitted with a third party element.

Do not interfere with the Alarm or attempt to tamper with it. This will invalidate the guarantee but more importantly may expose the user to shock or fire hazards.

This guarantee is in addition to your statutory rights as a consumer.

The crossed out wheelee bin symbol that is on your product indicates that this product should not be disposed of via the normal household waste stream. Proper disposal will prevent possible harm to the environment or to human health. When disposing of this product please separate it from other waste streams to ensure that it can be recycled in an environmentally sound manner. For more details on collection and proper disposal, please contact your local government office or the retailer where you purchased this product.



CE



KM86596

KM83678

EN50291-1:2010+A1:2012,
BS5446-2:2003



P/N B18659 Rev0
© Ei Electronics 2018

Aico Ltd. Mile End Business Park,
Maesbury Rd, Oswestry, Shropshire SY10 8NN, U.K.
Tel: 01691 664100

www.aico.co.uk

Ei Electronics. Shannon, Co Clare, Ireland.
Tel: +353 (0)61 471277

www.eielectronics.com