

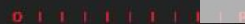

NIKOLATESLA PRIME

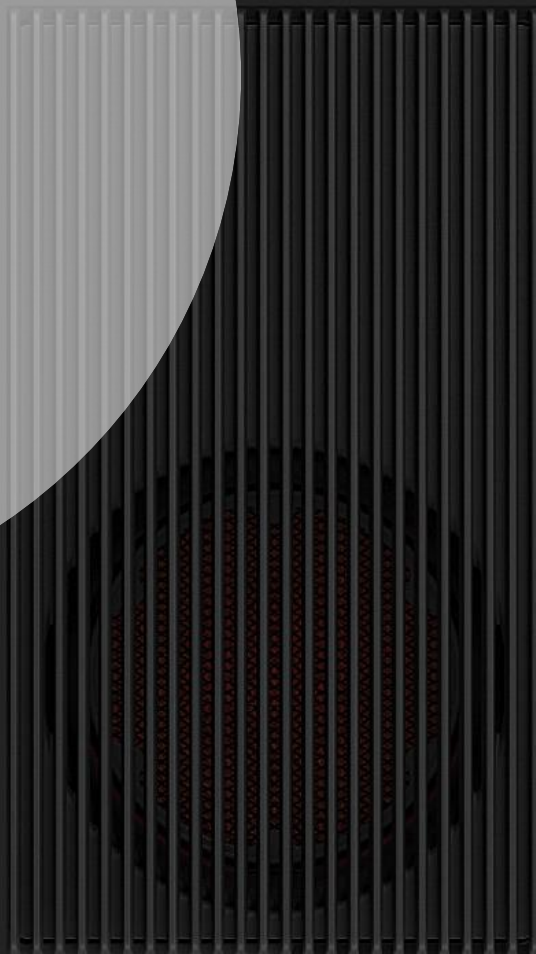

EUROCUCINA 2018

MILANO



HOOD AND HOB IN ONE

 **elica**
aria nuova

END BENEFIT

A hob and hood together in a single appliance.
Powerful and silent. User-friendly and easy to clean.

REASON WHY

POWERFUL AND SILENT

NIKOLA TESLA PRIME has an extraction speed of 5.1 m/sec and a noise level of just 61 db(A) at maximum speed. Unrivaled in its category.

EASY TO CLEAN AND EASY TO MAINTAIN

The new look guarantees the easy cleaning of both the top and cast iron grille, which can easily be placed in the dishwasher.

The internal section of the product can be accessed by removing the grease filters and the patented Elica system allows the odour filters to be directly extracted from the surface of the top: all cleaning and maintenance operations can be carried out in total comfort.

EASY TO USE

The DIRECT SLIDER navigation system allows simple and intuitive use of both the hob and hood.



PRODUCT DESCRIPTION

NikolaTesla Prime is the latest induction extractor hob by Elica created to revolutionise the daily cooking experience and turn the point of view of the kitchen literally upside down.

Induction and extraction are combined in a single product where the search for harmony and maximum attention to detail, together with innovative functions and unique performance, represent the highest expression of technology and design.

The surfaces of the new range of Elica extractor hobs are designed with easy cleaning in mind.

The product is provided with the Elica AIRCAPTURE system: the aspiration system adjust itself according to the quantity of the fumes and the kind of odours that are emitted, based on the set cooking power.





The control interface is intuitive and easy to use thanks to a single direct slider, used to control both the hob and the hood, and is totally invisible in standby mode, making this an extremely clean product in aesthetic terms. The cooking zones have 9 power levels + 1 booster, while the extraction zone has 3 speeds + 2 booster.

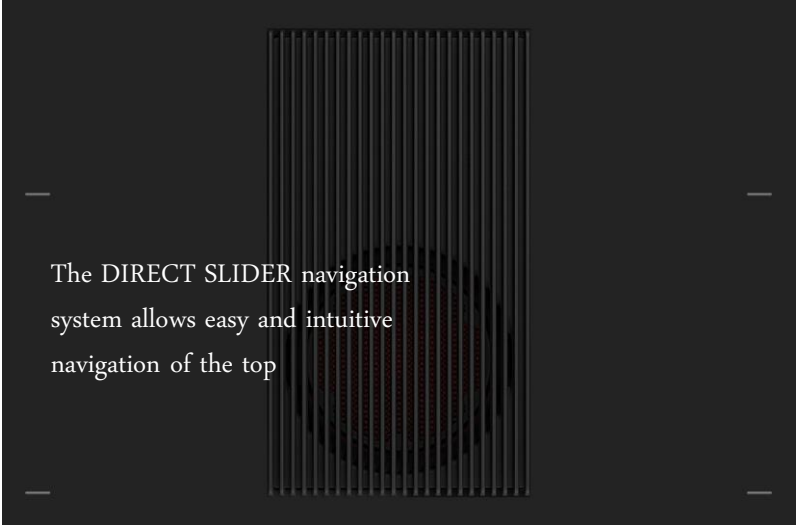

The DIRECT SLIDER navigation system allows easy and intuitive navigation of the top

OPERATION

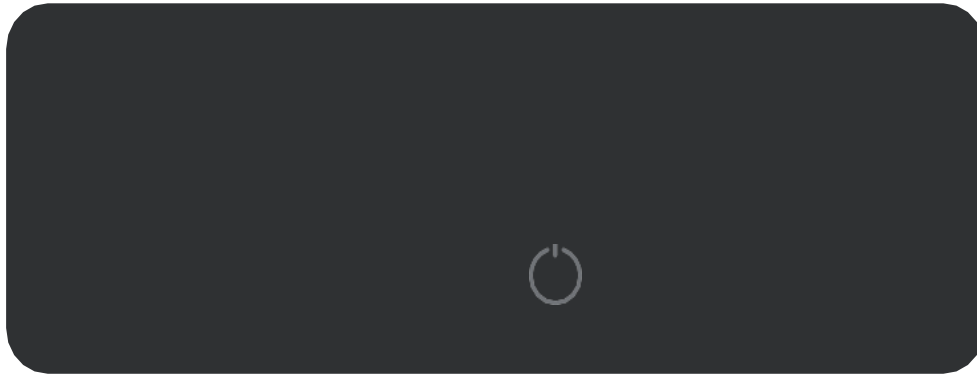

SYSTEM OFF



WEEK LIGHT



COMPLETE BOARD



BRIGHT LIGHT

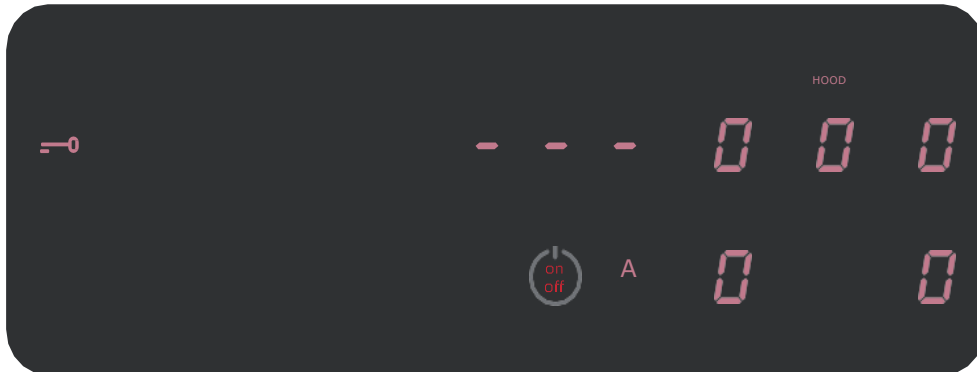

SELECTION FUNCTIONS ON



PULSE LIGHT

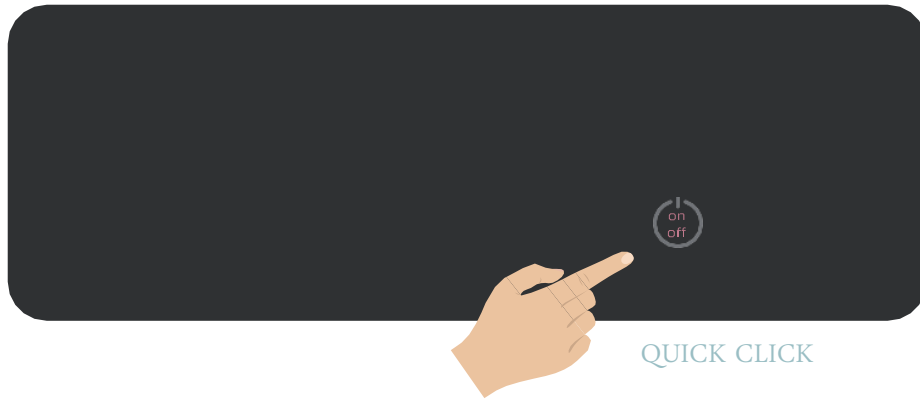

Each time we speak about PULSE we consider DIM in and DIM out.



SWITCHING ON AND OFF

Touch the ON/OFF Smart KII (2).

The cooktop is turned on. The power levels for all cooking zones show 0.

KEY	TOUCH	FUNCTION	FEEDBACK ON KEY 2
2	One quick click	shows ON/OFF key for 2 sec	o" *Weak Light 
2	1st continuous click	Product ON	o" *Bright light 
2	2nd continuous click (if product ON)	Product OFF	o" *Weak light delay 5 sec 



OPERATION

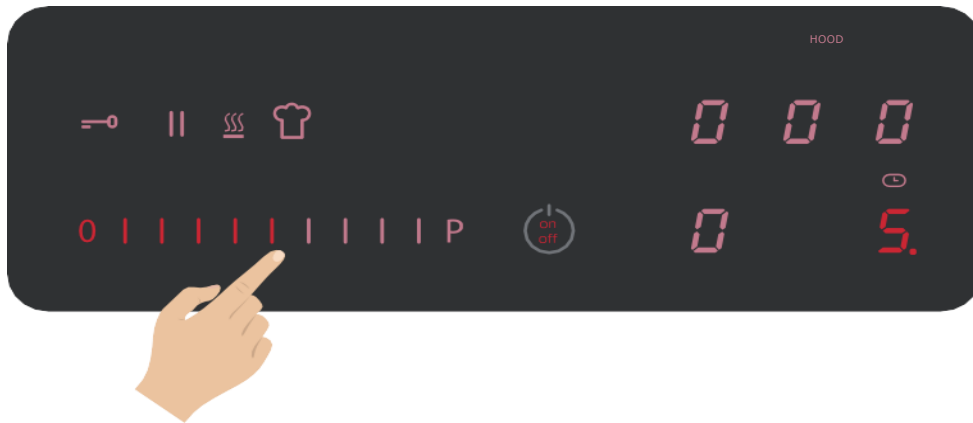
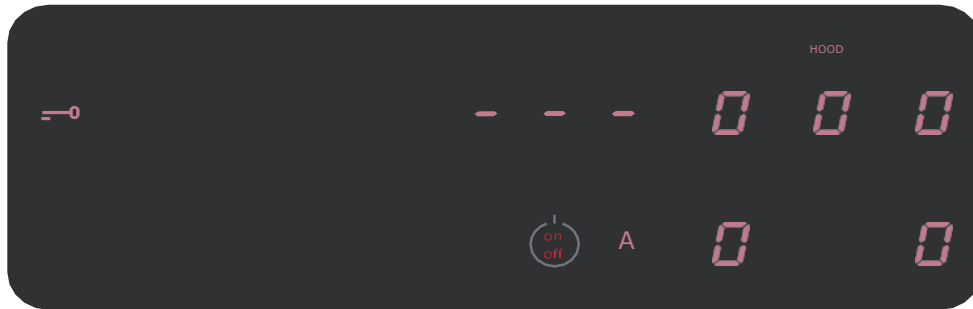

Cooking Zone Selection and Power Regulation

Touch the Smart KII for the desired cooking zone (4 a,b,c,d). Select the desired power level via the slider.

The power level for the cooking zone will appear bright.

OPERATION

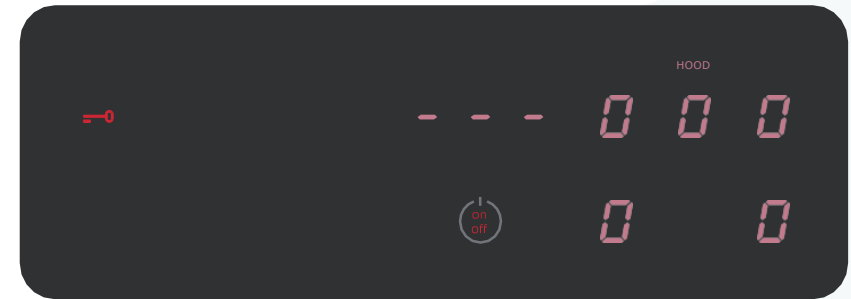
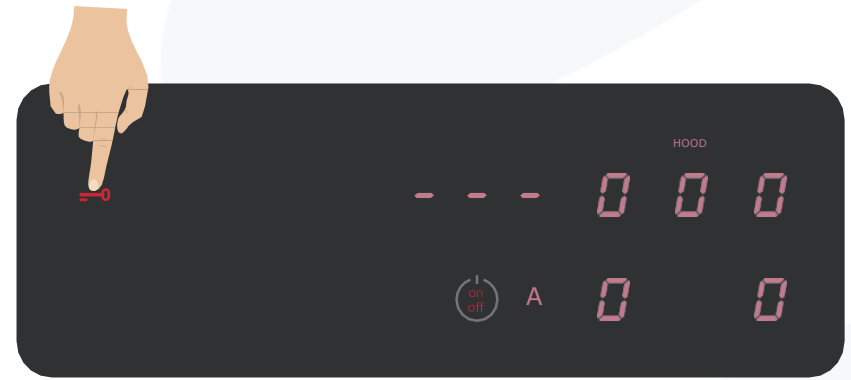

KEY LOCK ACTIVATION



Touch the special function key 13.

All keys except special function key 13 and the power key are locked, including the EXTRACTION ZONE

KEY LOCK DEACTIVATION

Touch the special function key 13 again.

The key lock is deactivated. The hob can be operated regularly.

KEY	TOUCH	FUNCTION	FEEDBACK ON KEY 13
13	1st click	Key lock ON	*bright light 
13	2nd click	Key lock OFF	*weak light 

OPERATION

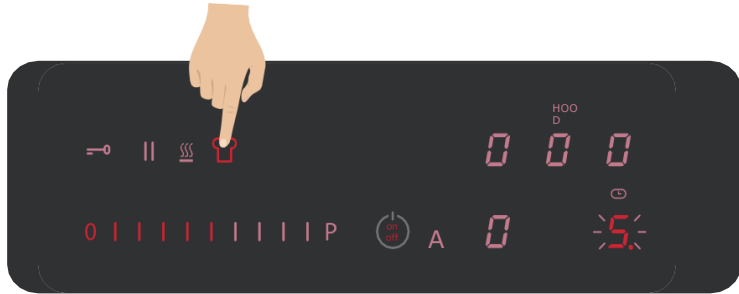

5 A

AUTOMATIC HEAT UP ACTIVATION

Touch the AUTOMATIC HEAT UP function key when one zone is activated.

The AUTOMATIC HEAT UP mode is activated. The displays for the cooking zones show POWER and A alternately for the entire time that AUTOMATIC HEAT UP is ON.



AUTOMATIC HEAT UP DEACTIVATION

Touch the AUTOMATIC HEAT UP function key.

The AUTOMATIC HEAT UP mode is deactivated. The power levels for the selected cooking zones are set to starting point.

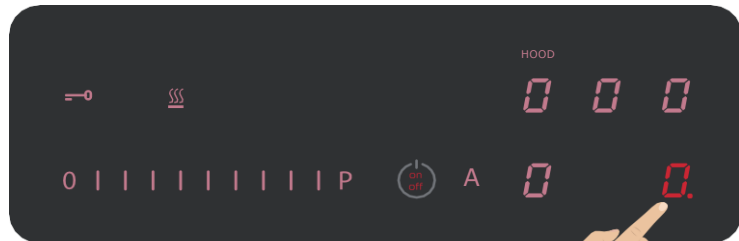

||

PAUSE FUNCTION ACTIVATION

Touch and hold the Pause Smart KII 1 for 1 s. All 7-segment displays for the cooking zones show. The pause function is active.

PAUSE FUNCTION DEACTIVATION

Touch and hold the Pause Smart KII for 1 s. The slider LED turns on and off from the first level on, indicating that the user must touch or use it. The pause function is terminated and the hob will continue with all previously set actions.

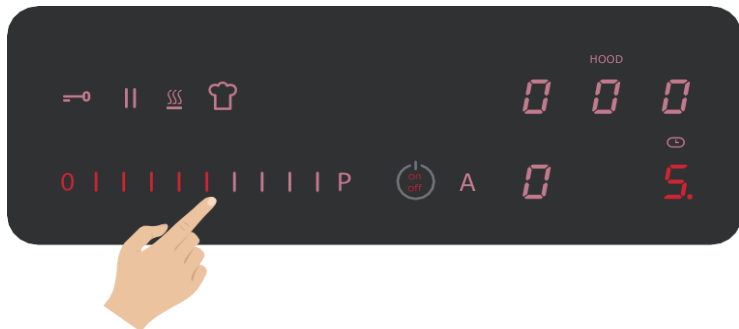

OPERATION



The Automatic function can be set at any time.

It is not necessary to select any cooking zones or the extraction zone to activate the Automatic function. It can be switched on at any time..



AUTOMATIC FUNCTION

Touch the automatic mode (A).

Extraction power works automatically (based on the cooking zone power).

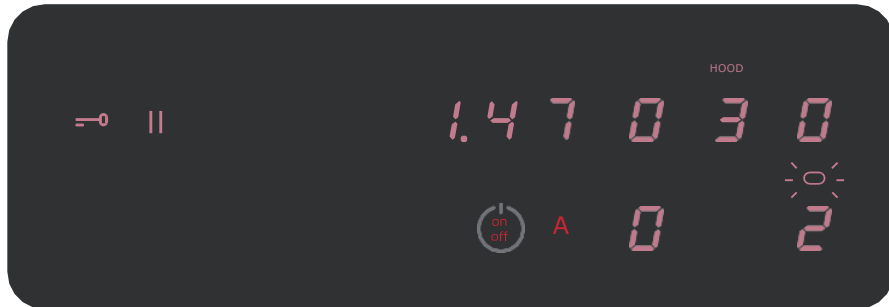

when AUTOMATIC MODE is ON

all extraction power can be managed automatically (according to the cooking zone power).

FINISHES AND VERSIONS

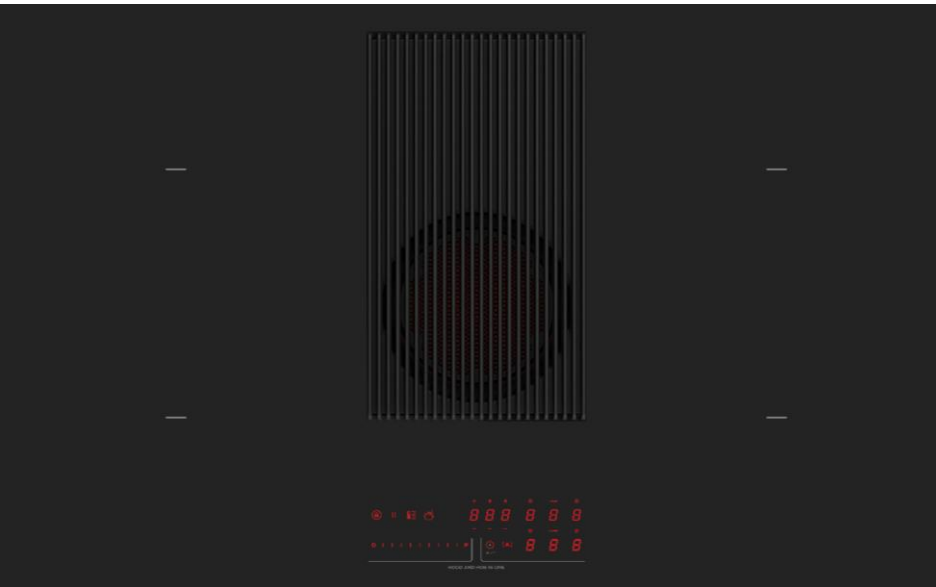

Black tempered glass with cast iron grille.

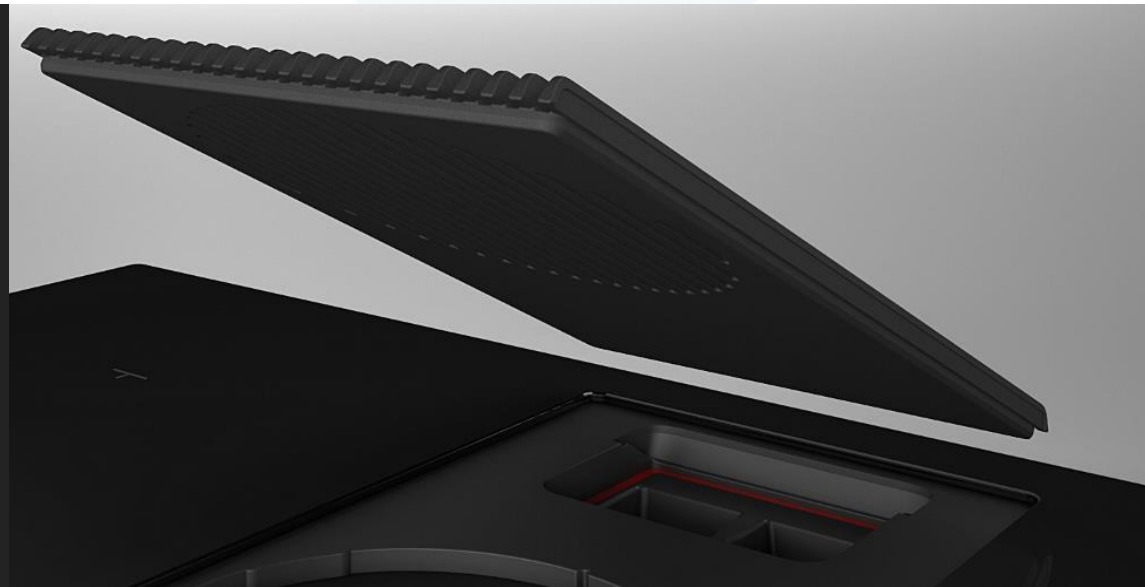

The product is available in both a filtration and extraction version.

The filtration version is equipped with odour filters and piping for standard installation using tubes long enough to reach below the plinth. For correct installation, it is recommended to purchase a commercial grille to be connected to the piping.



PRODUCT DATA SHEET (HOOD)

HOOD	Hood Control	Smart KII, 3S + 2B
	Airflow Boost	610 m ³ /h
	Suction Speed	5,1 m/s
	Noise Max	66 dbA
	Grease filter	Aluminium Grease Filter, 6 strati
	Odour filter	Synthetic filter
	Hood Absorption	310 W
	EEl	A
	LE	-
	FDE	A
	GFE	C

PRODUCT DATA SHEET (HOB)

HOB	Sizes			830x510x210
	Cut Sizes			807x492
	Cooking Zones			4 Round (2x200; 2x160mm)
	Minimum Pot diameter for cooking zone			Ø110mm (on 160mm zone) Ø120mm (on 200mm)
	Hob Control			Smart KII, 9S+B
	Hob Absorption			7,4 KW
	Lev 9 Absorption			2,1 kW
	Boost Absorption			3 kW
	Power Limitation			
	Child Lock			YES
	Pot Detector		NikolaTesla helps you save time and money. It informs you when a zone is ON and not being used, thus avoiding energy wastage, and automatically activates cooking zones are detected. All that's left to do is adjust the power level and enjoy your cooking.	YES
	Temperature Manager		Delight your guests with perfect meals every time using this function allowing you to configure the hob with 1 programme. Temperature reductions are optimised for very delicate cooking (mousse, sauces, keeping warm) and for cooking requiring higher levels of power (boiling).	1 Level, Keep Warm function
	Timer			YES
	Egg Timer			YES
	Stop & Go		If you're in the kitchen and they call you from another room, or if you simply need a break. By simply pressing the Stop&Go key you can deactivate all the cooking zones and move away in total safety.	YES
	Residual Heat Indicator			YES
	Safety Shut Down			YES
Automatic Heat UP			YES	

INSTALLATION

NikolaTesla has been designed to fit into any type of kitchen.

In the standard filtering version, NikolaTesla is equipped with all components needed for installation, Elica recommends using a commercial grille for best installation. In the extraction version, ducting is supplied as an accessory and users can choose the best configuration/solution, based on the architecture of their home.

NikolaTesla can be installed directly on the countertop (STANDARD) or inserted in a 1 mm slot, flush with the countertop (FILOTOP).



Duct-out



Recycling



Standard

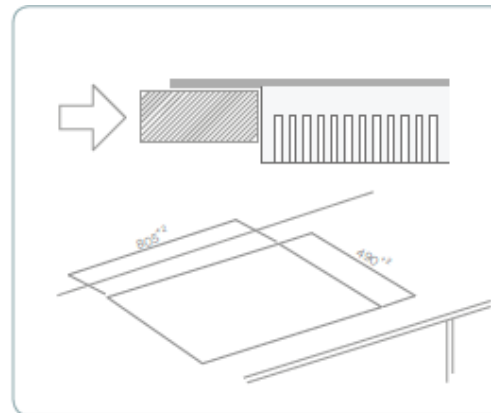

Filo Top

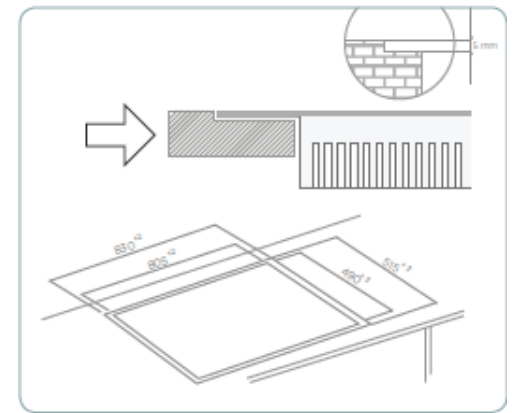

DUCT – OUT INSTALLATION

When NIKOLATESLA is installed in a modular kitchen where the duct hole is in the rear external wall, vapours and odours are channelled through a short pipe directly to the outside.

If the kitchen is not equipped with a duct hole in the rear part, vapours and odours can be channelled outside through special reduced pipes using the space underneath the bases.

In this case the height of the plinth has to be ≥ 100 mm.



(STANDARD CABINET – 600 mm)

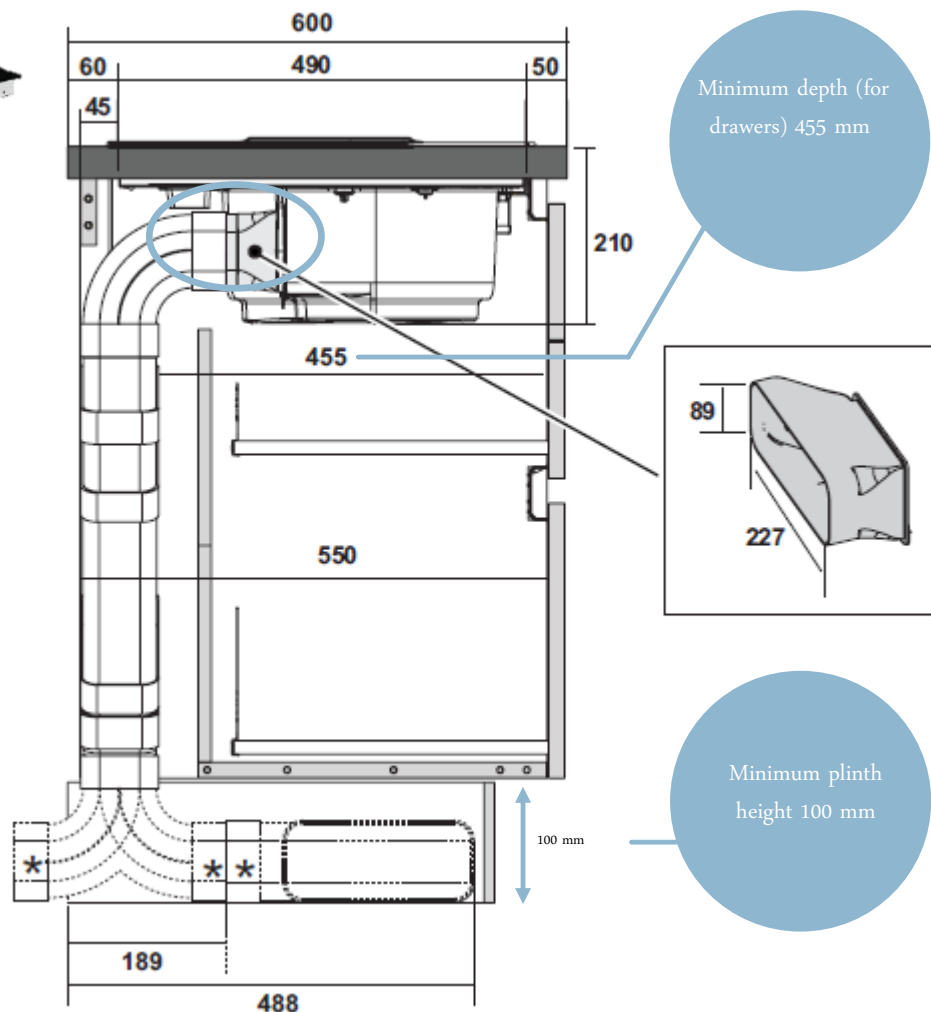

www.elica.com
www.shop.elica.com

DUCT – OUT INSTALLATION - ACCESSORIES

Elica provides a complete series of accessories for all types of installations.

KIT0121007



227x94 - Ø146mm

KIT0120996



Ø150x500mm

KIT0121000



Ø150x1000mm

KIT0121003



Ø158x59mm

KIT0121006



90°

KIT0120991



222x89x1000mm

KIT0121002



15° - 227x94mm

KIT0121001



227x94x80mm

KIT0121004



90° 227x288x94mm

KIT0121005



90° 227x94mm

KIT0121008



227x94 - Ø153mm

KIT0121010



190x190 - Ø147mm

KIT0121009



INT 216X82mm
EXT 290X160mm



RECYCLING INSTALLATION

NIKOLATESLA filtering version is ready for standard installation with the air outlet placed underneath the plinth.

Thanks to Elica components this installation is also possible in all kitchens with plinth height ≥ 60 mm.

Elica recommends using a commercial grille for best installation.

(STANDARD CABINET – 600 mm)

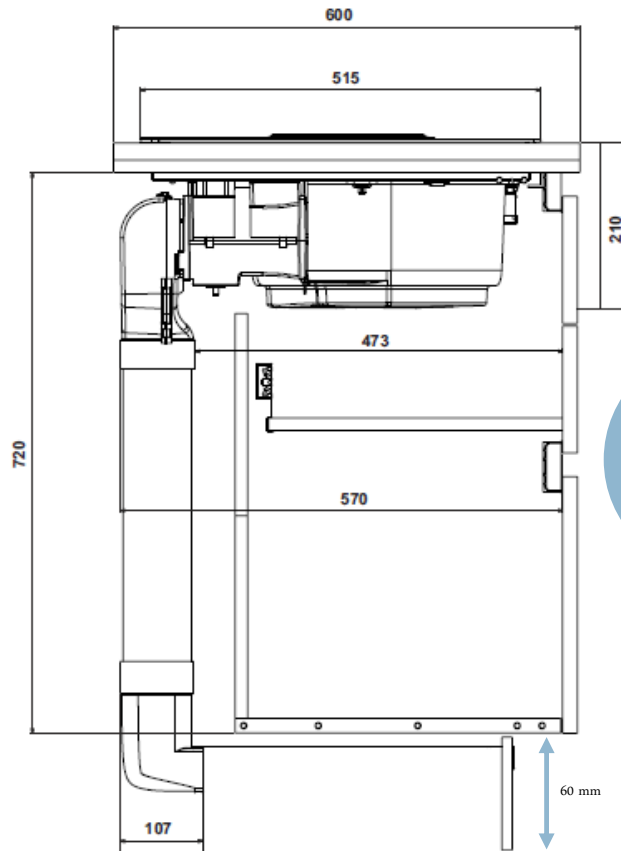

Minimum depth (for drawers) 450 mm

Minimum plinth height 60 mm

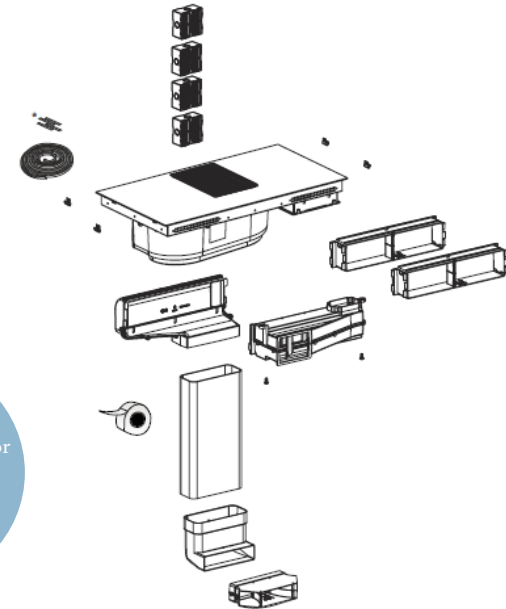

RECYCLING INSTALLATION



In order to improve the flexibility of the filtering installation (e.g. frontal between the cooking space and the sink or on a side outlet). Elica supplies a complete series of accessories for all needs.

KIT0121012



218X55X500mm

KIT0121013



218X55X1000mm

KIT0121015



218X55X70mm

KIT0121016



90° 218X55mm

KIT0121002



15° - 227x94mm

KIT0121005



90° 227x94mm

KIT0130427



For installation
greater than 70
cm



MAINTENANCE

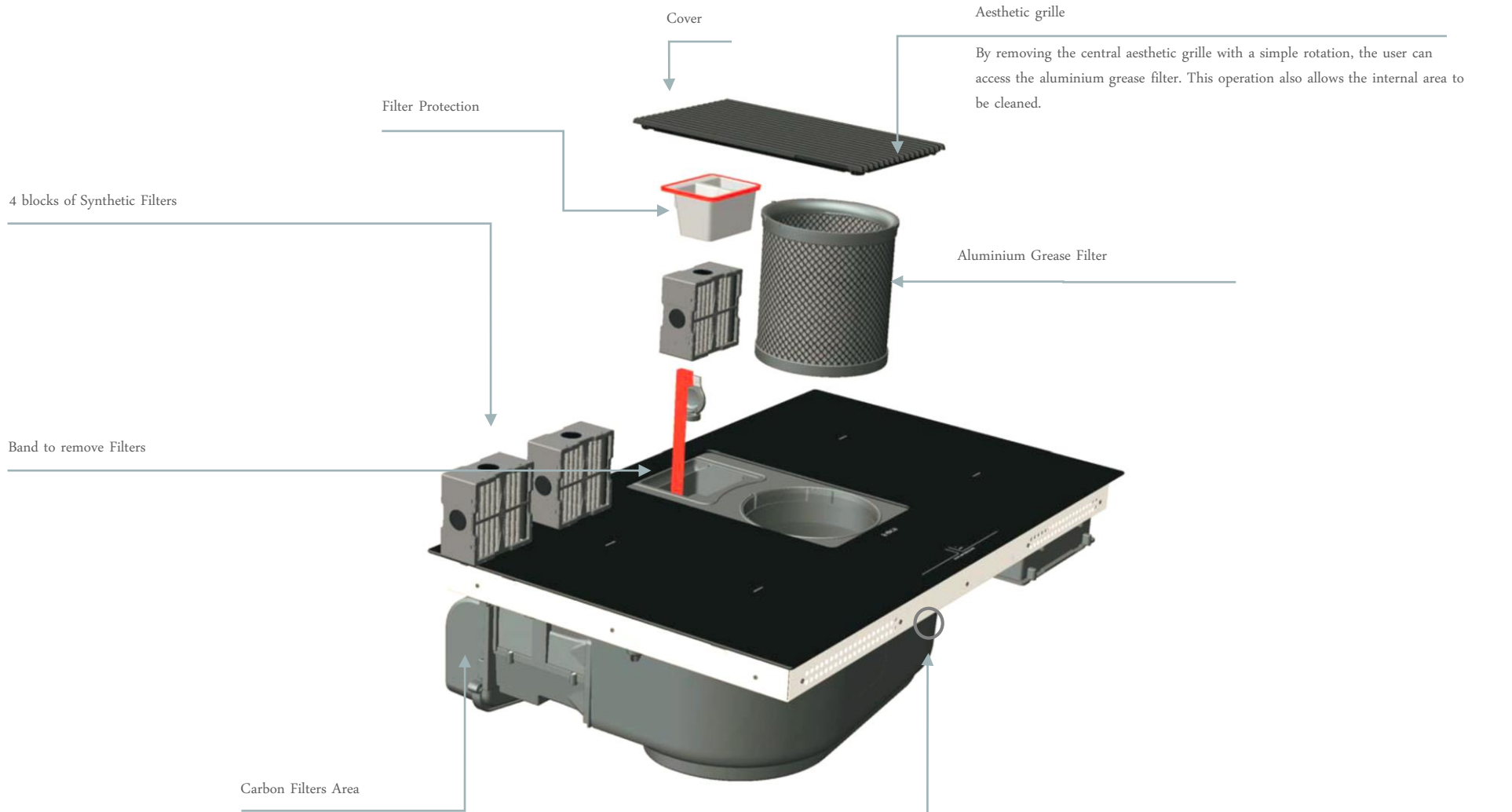

Aesthetic grille

By removing the central aesthetic grille with a simple rotation, the user can access the aluminium grease filter. This operation also allows the internal area to be cleaned.

Aluminium Grease Filter

If a large quantity of liquid accidentally spills out of the pots, the drain valve located on the lower part of the product can be opened so as to remove any residue and allow cleaning with maximum hygiene

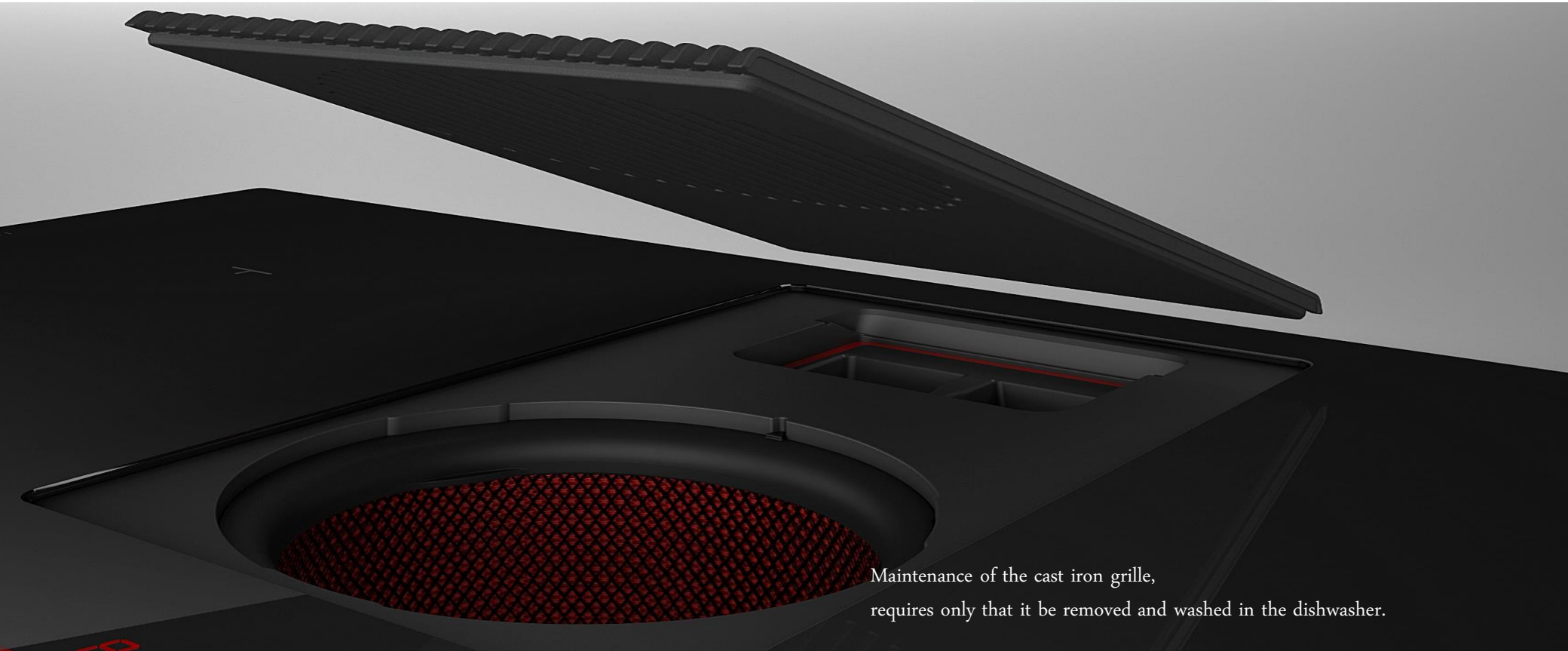

Maintenance of the cast iron grille, requires only that it be removed and washed in the dishwasher.

By removing the grille, the grease filter can be removed and washed in the dishwasher. Moreover, the liquid collection channel, which can hold up to 5 litres, can be reached from this opening.

The odour filters are located in the rear part of the hob.

PATENTS

Elica has applied for the following patents for NikolaTesla Prime:

- PCT/IB2016/056854 (International): odour filter extraction directly from the top of the hob.
- PCT/IB2016/057022 (International): odour filter extraction through a tape.
- PCT/IB2017/051685 (International): extraction system configuration (specifically the blower and its position underneath the product).
- PCT/IB2017/053538 (International): anti-vibration fastening system for the motor.
- PCT/IB2017/053558 (International): fastening of the lower basin with magnets.
- IT/102017000095549 (Italian): alternative methods for the extraction of the odour filters from the top (not present in the current product, to be eventually developed for the future)