

Our mission remains to provide our consumers with the means to create a perfect pond simply.

Our unique capability is to harness years of experience in pond keeping to advanced engineering to deliver products that we believe are a class apart in functional performance and ease of use.

This philosophy is summed up by our slogan,

'perfect ponds made simple'

New for 2005

EasyClear™

Clearwater and Fountain Pump

Hozelock Cyprio has driven the aquatics market with innovative products that satisfy real consumer needs and lead to 'perfect ponds made simple'

For 2005 Hozelock Cyprio has taken another great leap forward with the introduction of the EasyClear™ Clearwater and Fountain Pump. This is a truly innovative product that will significantly grow the market by appealing to owners of smaller ponds who do not have a pump or filter and by encouraging millions of potential pond owners to take the step to build their first pond.

The EasyClear™ Clearwater and Fountain Pump is the easy way to have a clear and healthy pond with a fountain. This fully integrated unit has a 2 in 1 action:

1 Clear and healthy water

- The filter sieves out solids that make the water cloudy and makes the water healthy for fish and plants.
- The ultra violet clarifier eliminates green water.

2 Fountain

- The fountain creates a decorative display with a choice of three fountain heads.

The whole unit is easily placed in the water so that there is no need for a filter system outside the pond, which can be difficult to disguise.

Guaranteeing Clearwater for ponds of up to 2000 litres capacity, the EasyClear™ has a multitude of features that make installation, operation and maintenance very easy. See page 16-17 for full details.

The aquatics industry continues to grow and develop and we recognise that the demands on manufacturers and suppliers are increasing accordingly. Product performance and reliability, combined with top rate trade and consumer support, are vital for ensuring the future success of both ourselves and our customers.

Our winning combination of product range and market support has been a major ingredient in the successful generation of sales growth for our customers around the world. This, together with continuous investment in our business, has meant that we can confidently offer the services of a top quality operation.



A top quality operation



Technical leadership in product research and development with an expert team of engineers and the latest computerised design facilities.



Extensive product testing facilities enable accurate measurement of product performance in realistic conditions.



Large scale manufacturing base. Implementing 'Fail Safe' manufacturing and assembly procedures to ensure product quality.



High service levels with a state of the art distribution centre. The computerised storage system ensures high speed location of product and despatch.



High profile marketing support concentrates on making it easier for the trade to sell Hozelock Cyprio products and easier for the consumer to understand and buy them.



Top quality trade and consumer after sales service ensuring that help is always at hand.

contents

Cascade™ Fountain and waterfall pumps	02 - 04
Pump Comparison Chart	05
Titan® Filter and waterfall pumps	06 - 07
Prima® XL Filter pumps	08
Clearwater Systems Pond filtration	09 - 10
Ecoclear™ Compact filtration systems	11
Bioforce® Compact pressurised pond filters	12 - 13
Ecopower™ and Ecomax™ Pond filters with integral ultra violet clarifier	14 - 15
EasyClear™ Clearwater and Fountain Pump	16 - 17
Ecocel™ Conventional biological pond filters	18
Green Machine® Conventional biological pond filters	19
Vorton™ Ultra violet clarifiers	20 - 21
Pre-formed Ponds and Liners	22
Filtration Selection Chart	23
Aqua-glow™ In-pond lighting	24
Pebble Fountain	25
Fish Food and Pond Treatments	26
Cypriflex™ Pond Hose	27
Pond Accessories	28
Pioneers in Category Management	29





cascade pumps

Ideal all purpose pond pump

A Cascade is the best pump for general pond keepers and newcomers to the hobby because it is designed for a range of functions



Perfect Ponds Made Simple

Cascade performance data

Use this guide to help your customers choose which Cascade they need. It is only a guide as, with waterfalls, the flow is affected by the height of the waterfall, diameter and length of hose.

Waterfall figures are based on 2.5metres of 1" dia. hose. (1000-4000 @ head 0.6m, 5500-7000 @ head 0.8m) The length and diameter of hose will affect performance.

Cascade Performance Data

Model	Max Fountain Height	Bell Jet Diameter	Waterfall Width	Combined	
				Fountain	Waterfall
450	0.63 m (2' 01")	-	-	-	-
700	0.75 m (2' 05")	0.35 m (1' 02")	-	-	-
1000	1.16 m (3' 10")	0.38 m (1' 03")	0.11 m (0' 04")	-	-
1500	1.20 m (3' 11")	0.40 m (1' 04")	0.12 m (0' 05")	0.55 m (1' 10")	0.10 m (0' 04")
2000	1.30 m (4' 03")	0.60 m (2' 00")	0.13 m (0' 05")	0.60 m (2' 00")	0.10 m (0' 04")
3000	1.40 m (4' 07")	0.65 m (2' 02")	0.20 m (0' 08")	1.00 m (3' 03")	0.19 m (0' 07")
4000	1.60 m (5' 03")	0.70 m (2' 04")	0.30 m (1' 00")	1.20 m (3' 11")	0.25 m (0' 10")
5500	3.25 m (10' 08")	0.70 m (2' 04")	0.40 m (1' 04")	2.00 m (6' 07")	0.35 m (1' 02")
7000	3.50 m (11' 06")	0.70 m (2' 04")	0.55 m (1' 10")	2.20 m (7' 03")	0.45 m (1' 06")

Hozelock Cyprio Cascades are a well known world leader selling in hundreds of thousands each year.

They are available in a wide variety of sizes from the 450, for ornaments, to the 7000 which can power a fountain, waterfall, ornament and filter at the same time.

Use a Cascade for:

Fountains - they all come complete with a selection of distinctive spray fountains (except Cascade 450i and 700i) and the Cascade 700 to 4000 with a bell jet.

Waterfalls - the Cascade 1000 will give a good small waterfall and the 7000 will give a torrent. Cascades from 1000 up come with a flow controller that enables them to be used for two purposes at the same time.

Ornaments - using the flow controller an ornament can be connected in addition to a fountain or waterfall.

Filtration - water can be pumped to a filter and back to the pond, direct or down a waterfall. Filtration will be more effective if a Titan solids handling pump is used.

Key features of Cascade pumps

More Performance

Cascades with the UBI multi blade impeller and OMC motor design provide unparalleled performance with low running costs - 4000LPH with 40 Watts power consumption for the Cascade 4000.

More reliability

All Cascades from 1000 upwards are unique in using TRF technology to protect the motor from damage. If the pump becomes blocked, this solid state technology switches the motor off until power to the motor is disconnected and the blockage removed.



All Cascades from 2000 upwards use a ceramic shaft and bearings for extra life.

These features allow us to offer a 3 year guarantee with confidence.

Easy to Use

Easy to clean, anti clog, foam free strainer greatly increases maintenance intervals. When cleaning is required, tool free access and quick release hose connection keeps this simple.

For improved in pond stability, the 700-4000 Cascades have an ultra low centre of gravity and wide base. The 450 outdoor pump comes with optional base plate for stability.

All Cascades, except 450i and 700i, have a complete range of accessories to allow a broad range of uses. Specifically the 1500 - 4000 Cascades now have a 'T' piece with dual flow control, telescopic extension tube, 2 fountain heads, bell jet and a quick release hose connector.

Cascade LV

Hozelock Cyprio has the largest range of low voltage (LV) pumps. Low voltage Cascades now range from 700 to 4000 litres per hour.

These pumps offer identical performance to the mains versions, but as the power supply to the motor is only 24 volts they offer easy fit DIY installation.

The main features are:

- The mains connection to the transformer is remote from the pond.
- All LV pumps come with 3m of cable, which can be simply extended up to 50m without loss of performance. This cable need not be buried and protected, greatly simplifying installation.
- Click connection for LV supply is simple and reliable.
- Identical features and accessories to the mains Cascades.

Part Number	Description	Product Bar Code	Pack Qty
3304	Cascade 450i Indoor Pump	50 10646 01893 7	5
3303	Cascade 450 - 230v	50 10646 03129 5	5
3362	Cascade 700i Indoor Pump	50 10646 03570 5	5
3352	Cascade 700 - 230v	50 10646 03576 7	5
3353	Cascade 1000 - 230v	50 10646 03555 2	5
3354	Cascade 1500 - 230v	50 10646 03569 9	5
3324	Cascade 2000 - 230v	50 10646 03081 6	3
3334	Cascade 3000 - 230v	50 10646 03082 3	3
3344	Cascade 4000 - 230v	50 10646 03083 0	3
3350	Cascade 5500 - 230v	50 10646 01115 0	2
3360	Cascade 7000 - 230v	50 10646 01116 7	2
3052	Cascade 700LV	50 10646 03568 2	5
3053	Cascade 1000LV	50 10646 03554 5	5
3024	Cascade 2000LV	50 10646 03078 6	3
3044	Cascade 4000LV	50 10646 03080 9	3

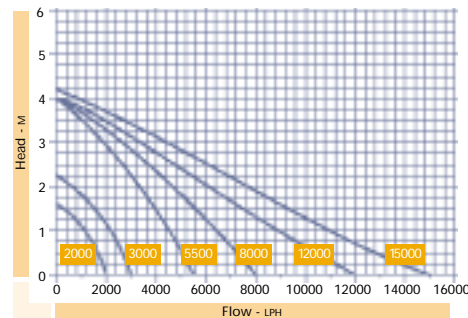

Titan Performance Data

Model	Max Flow	Max Head	Flow @ 1m	Solids Handling Range	Waterfall Width @ 0.6m	Waterfall Width @ 1m	Hose Diameter
2000	2000LPH (440GPH)	1.60 m (5' 03")	1100 LPH (250GPH)	0 - 4 mm	0.10 m (0' 04")	0.08 m (0' 03")	20 - 40 mm
3000	3000LPH (660GPH)	2.30 m (7' 06")	2200 LPH (500GPH)	0 - 4 mm	0.18 m (0' 07")	0.15 m (0' 06")	20 - 40 mm
5500	5500LPH (1210GPH)	3.80 m (12' 06")	4500 LPH (1000GPH)	0 - 8 mm	0.36 m (1' 02")	0.29 m (1' 00")	20 - 40 mm
8000	8000LPH (1500GPH)	4.00 m (13' 02")	6800 LPH (1500GPH)	0 - 8 mm	0.48 m (1' 07")	0.38 m (1' 03")	20 - 40 mm
12000	12000LPH (2600GPH)	4.00 m (13' 02")	9000 LPH (2000GPH)	2 - 10 mm	0.99 m (3' 02")	0.83 m (2' 07")	20 - 40 mm
15000	15000LPH (3300GPH)	4.20 m (13' 09")	11000 LPH (2400GPH)	2 - 10 mm	1.23 m (4' 00")	1.07 m (3' 05")	20 - 40 mm

The pages that follow, on filtration, explain in detail how a solids handling pump fits in with the whole Cyprio filtration philosophy that has so successfully kept ponds clear for 20 years.

Get the polluting solids out of the pond into a filter where they help the growth of beneficial bacteria and can also be much more easily collected and disposed of. Titan pumps are specifically designed for this purpose.

Use a Titan for:

In addition to filtration, Titans are also excellent pumps for waterfalls and watercourses. This is because they can pump high volumes of water in continuous use, with high resistance to clogging.

Of course, many customers will take pond water to a filter and then back to the pond via a waterfall. This is particularly attractive with Bioforce filters as the water leaves the filter under pressure and so can be run up to the waterfall, leaving the Bioforce hidden below.

Key Features of Titan Pumps

The Titan range has been specifically designed for continuous running with minimum cleaning. Titans have the ability to pump solid particles up to 10mm without blocking (4mm with Titan 2000, 3000 - 8mm with 5500 and 8000 - and 10mm with 12000 and 15000). They are suitable for filtration, waterfalls and watercourses.

More Performance

The large intake slots at the base of the pump minimise obstruction to solid particle migration and are specifically placed at the base of the pump in order to collect solids from the floor of the pond. This design maximises the effectiveness of the pump for filtration.

All Titans have unidirectional rotation to maximise pumping efficiency, with open impellers to provide the solids handling capability. (Solids Handling System - SHS)

The Titan 2000 & 3000 use the motor from the mid range Cascades providing unparalleled performance with low running costs.

The larger Titans use heavy duty, asynchronous motors. These use stainless steel rotor sleeving to increase magnetic coupling for maximum performance.

More reliable

Titans are designed to work in the most demanding of pond environments and have to cope with continuous operation, pumping water laden with solid material. The special design of these pumps ensures that they can confidently be offered with a three year guarantee.

All Titans are unique in using TRF protection to prevent motor damage.

All Titans use ceramic shaft and bearings throughout for maximum life.

Easy to use

The Titan range is a new generation of solids handling pumps, with unique features to maximise ease of use;

- Each Titan incorporates an anti clog cage.
- In order to ensure the safety of small aquatic life at spawning time the Titan features a unique Wildlife Protection System (WPS). Just slide the lever on the side of the pump to close the intake slot holes down to as small as 2mm.
- The hose can be positioned to lie along the bottom of the pond in any direction from the pump. The inclusion of a ball joint on the pump outlet now makes this even easier.
- Tool free access when maintenance is required. Extra secure locking latches have been added to the cages to hold the pump firmly together yet still allow tool free access.

Guarantee

Titan pumps are guaranteed for 3 years continuous use.

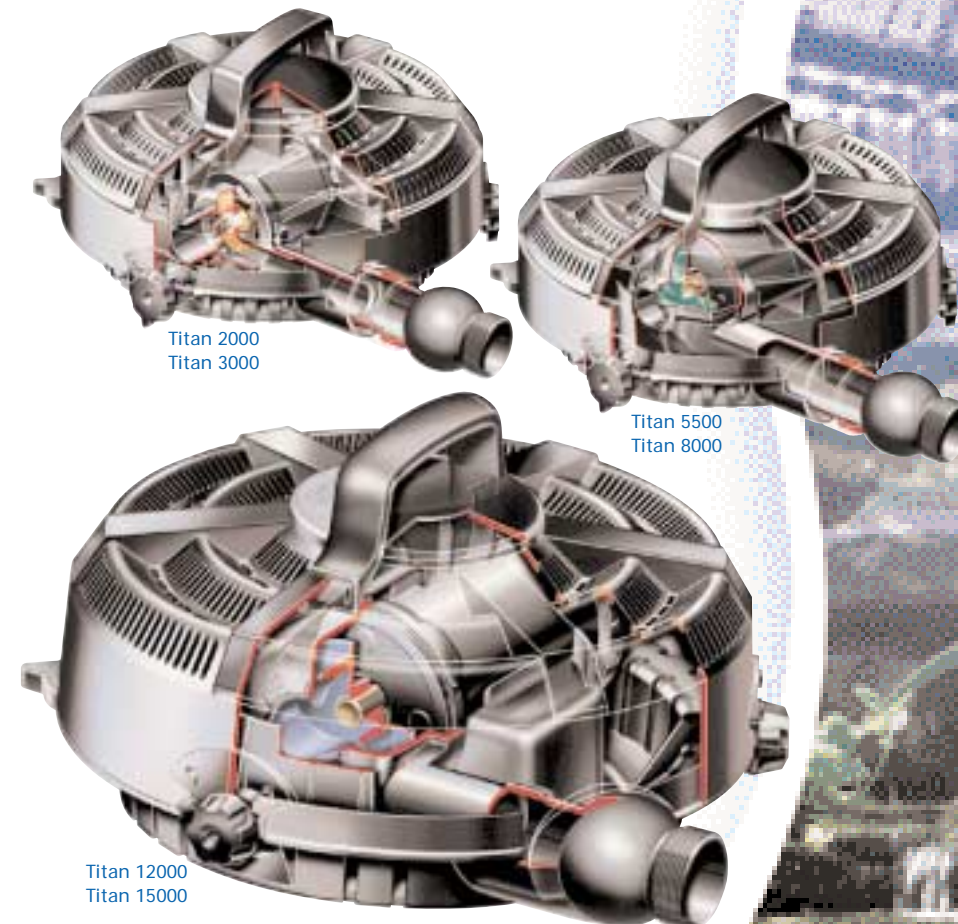

titan® pumps

Solids handling pump for waterfalls and filtration



P e r f e c t P o n d s M a d e S i m p l e

Part number	Description	Product Bar Code	Pack Qty
1451	Titan 2000	50 10646 03250 6	2
1452	Titan 3000	50 10646 03084 7	2
1454	Titan 5500	50 10646 03085 4	2
1456	Titan 8000	50 10646 03086 1	2
1457	Titan 12000	50 10646 03677 1	1
1458	Titan 15000	50 10646 03678 8	1
1470	Titan Outlet Adaptor (20 - 40mm)	50 10646 03212 4	1
1460	Titan 2000 Impeller	50 10646 03211 7	5
1461	Titan 3000 Impeller	50 10646 03210 0	5

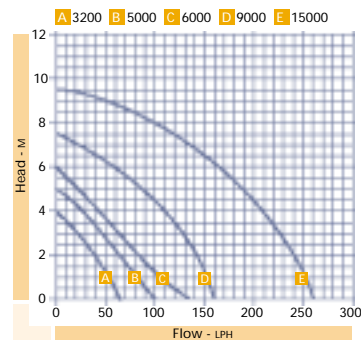

Prima XL Performance Data

Model	Max Flow	Max Head	Flow @ 1.2m	Solids Handling Range	Waterfall Width @ 1m	Waterfall Width @ 2m	Hose Diameter
3200 XL	4000LPH (880GPH)	4.0 m (13' 01")	3200LPH (704GPH)	0 - 8 mm	0.22 m (0' 09")	0.16 m (0' 06")	20 - 40 mm
5000 XL	6000LPH (1320GPH)	5.0 m (16' 05")	5000LPH (1100GPH)	0 - 8 mm	0.34 m (1' 01")	0.26 m (0' 10")	20 - 40 mm
6000 XL	8000LPH (1760GPH)	6.0 m (19' 08")	6250LPH (1375GPH)	0 - 8 mm	0.42 m (1' 05")	0.34 m (1' 01")	20 - 40 mm
9000 XL	9600LPH (2112GPH)	7.5 m (24' 07")	9000LPH (2000GPH)	0 - 10 mm	0.61 m (2' 00")	0.57 m (1' 10")	20 - 40 mm
15000 XL	15600LPH (3432GPH)	9.6 m (31' 06")	14000LPH (3432GPH)	0 - 10 mm	1.01 m (3' 04")	0.97 m (3' 02")	20 - 40 mm

prima xl pumps

Prima XL pumps are high pressure, solids handling pumps, designed specifically to pass large solids, up to 10mm in size, from the pond to a biological filter

Prima XL pumps are designed to have the power to pump high volumes of contaminated water through the restrictions encountered in most filter systems.

Prima XL pumps have a powerful 230volt motor, which is cased in a protective stainless steel case for reliability. With a ceramic sleeve rotating on a triple lip sealed shaft, the working parts are designed to give continuous optimal performance well beyond the two year guarantee. To aid installation, the Prima XL can be placed flat on the bottom of the pond or in an upright position.

Two large Prima XL pumps were added to the range in 2001; Prima XL 9000 and Prima XL 15000. These pumps are available with an optional float switch that will turn the pump off if the water drops below a certain level.

The Prima XL pump range complements the range of conventional Green Machine biological filters, with capacities ranging from 6500 litres up to 27000 litres.

To make pump selection easier Prima XL pumps are all rated at 1.2m (4ft) to allow for flow losses due to a UVC, a spray bar, pipework, and allowance for lift up to a filter.



PrimaXL 3200

Part number	Description	Product Bar Code	Pack Qty
1411	Prima XL 3200	50 10646 02820 2	1
1412	Prima XL 5000	50 10646 02821 9	1
1413	Prima XL 6000	50 10646 02822 6	1
1422	Prima XL 9000	50 10646 03092 2	1
1423	Prima XL 9000 Auto	50 10646 03100 4	1
1425	Prima XL 15000	50 10646 03096 0	1
1429	Prima XL 15000 Auto	50 10646 03102 8	1
1424	Prima XL Base Adaptor	50 10646 02946 9	1



clearwater systems

We have been guaranteeing clearwater for over 21 years



The Hozelock Cyprio Pedigree in Pond Management

Our filtration pedigree stretches back to 1982, when Cyprio was formed, based on a combination of specialist expertise in industrial water treatment and a passion for fishkeeping. Cyprio was the first company to introduce mass produced 'black box' filters, and UVCs for fishkeepers. Cyprio then led the way to introduce the Clearwater Guarantee and remains the only company to confidently back this up.

In 1997, when Cyprio was acquired by Hozelock, these strengths in natural water cleaning were combined with the technological strengths of Hozelock built up over 40 years.

Proven, Practical Technology that works

Hozelock Cyprio has the largest and most advanced pond testing facility. Results from this have shaped the development of successive ranges of filters, pumps and UVC's, building a bank of experience which is unrivalled in the industry.

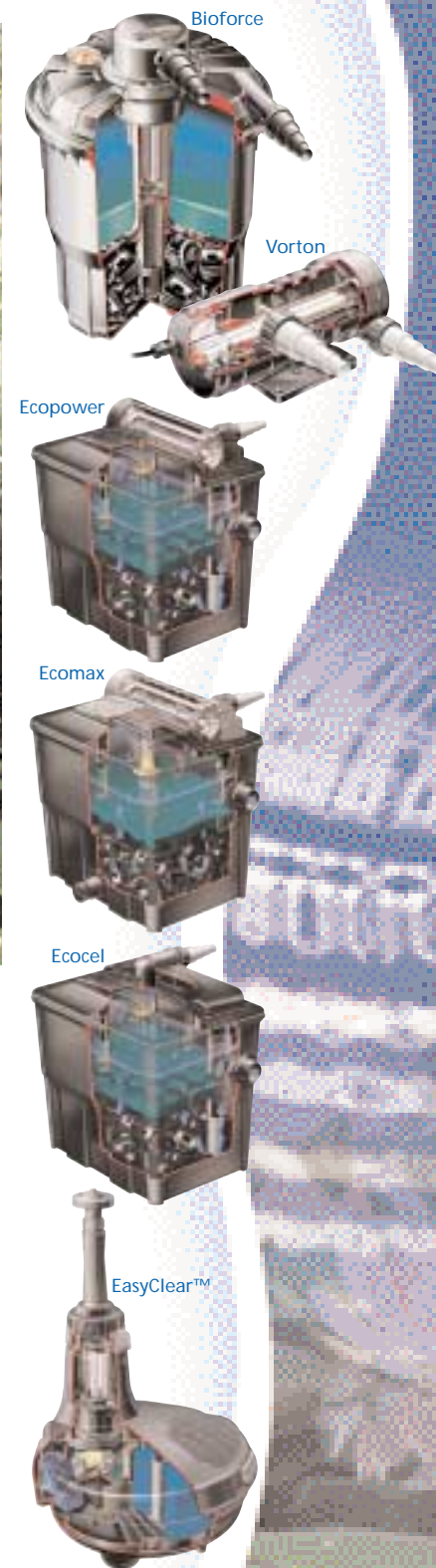



clearwater systems

We have been guaranteeing clearwater for over 21 years

Calculate how much water a rectangular shaped pond will hold

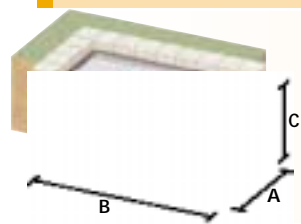

$$A \text{ metres} \times B \text{ metres} \times C \text{ metres} = \text{Volume m}^3$$

$$\text{Volume m}^3 \times 1000 = \text{Litres Capacity}$$

Calculate how much water a triangular shaped pond will hold

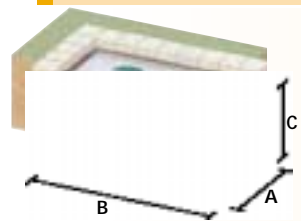

$$(A \text{ metres} \times B \text{ metres} \times C \text{ metres}) \div 2 = \text{Volume m}^3$$

$$\text{Volume m}^3 \times 1000 = \text{Litres Capacity}$$

Calculate how much water a circular shaped pond will hold

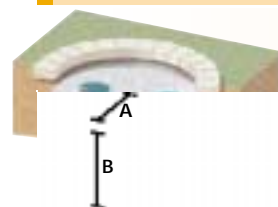

$$A \text{ metres} \times A \text{ metres} \times 3.14 = \text{Surface Area in m}^2$$

$$\text{Surface Area in m}^2 \times B \text{ metres} = \text{Volume m}^3$$

$$\text{Volume m}^3 \times 1000 = \text{Litres Capacity}$$

Why Filtration?

The typical garden pond easily becomes polluted because:

- Fish waste and decaying vegetation pollute the water.
- It has little water movement.
- It is shallow and therefore warm, encouraging algae blooms.

A lack of water movement, plus the presence of algae, can reduce oxygen to dangerously low levels. A Hozelock Cyprio filtration system will help create and maintain a natural balance in a garden pond - using our advanced technology to provide natural processes with a helping hand.

Sizing a pond and the system required

Achieving clear water and qualifying for the Clearwater Guarantee depend on having the correctly sized filtration system.

The products you need are dependent on :

- **The size of your pond**
- **The number of fish**
- **The temperature of the water** - warmer water encourages algae to grow, increases pollutants and reduces oxygen. If in warm climate add 15% to actual pond volume. If in hot climate add 35% to actual pond volume
- **Pond Depth** - average pond water depth less than 0.75m (2'6") Add 25% to actual pond volume
- **Pond Location** - if in full sun add 25% to actual pond volume

Selecting the right equipment 'on-line'

Visit the interactive pond selector on our website;

www.hozelock.com

Simply enter your pond details and it will give you a detailed recommendation covering all the factors above.



compact filtration systems

Biological pond filters with built-in ultra violet clarifier for clear and healthy pond water

A compact filtration system is for people who want a convenient filtration system, which will not detract from the beauty of their pond design. Two products - the Bioforce UVC pressurised filter and the Titan solids handling pump, will look after ponds up to 18000 litres (4000 gallons), and form the basis of our compact filtration philosophy.

1 Solids Handling Pump

The range of specially developed Titan solids handling pumps move polluting solids out of the pond into the filter where they can easily be removed.

2 Biological Pond Filter with integral UVC

The Bioforce UVC is small and can be hidden in the ground. It is very easy to install and simple to maintain.

Being pressurised by the pond pump, water can be pumped up from the Bioforce to the top of a waterfall.

The Ecopower and Ecomax gravity pond filters combine mechanical, biological and UV-filtration in one compact unit to guarantee clear and healthy pond water. Unlike the Bioforce, the Ecopower and Ecomax, are not pressurised from the filter and water returns to the pond by gravity.

The EasyClear™ Clearwater and Fountain Pump is the easy way to have a clear and healthy pond with a fountain. This fully integrated unit has a 2 in 1 action:

1 Clear and healthy water

- The filter sieves out solids that make the water cloudy and makes the water healthy for fish and plants.
- The ultra violet clarifier eliminates green water.

2 Fountain

- The fountain creates a decorative display with a choice of three fountain heads.

The correctly sized compact filtration package will qualify for our unique Clearwater Guarantee.

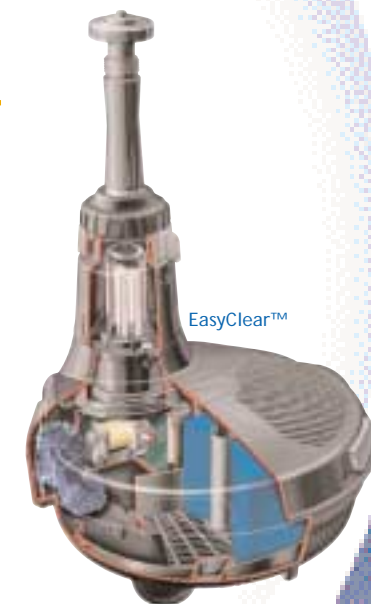

In order to make the purchase of a compact filtration system as easy as possible, Hozelock Cyprio sell four sizes of Ecoclear compact filtration kits. Each Ecoclear is a filtration system suitable for a specific size of pond.

An Ecoclear kit contains a Titan solids handling pump and Bioforce UVC pressurised filter. If the correct size Ecoclear is selected, Hozelock Cyprio guarantee clearwater.



Part number	Description	Product Bar Code	Pack Qty
1326	Ecoclear 2200	50 10646 03282 7	1
1327	Ecoclear 4500	50 10646 03491 3	1
1328	Ecoclear 9000	50 10646 03493 7	1
1329	Ecoclear 18000	50 10646 03679 5	1

Model	Filter	Pump
Ecoclear 2200	Bioforce 2200uvc	Titan 2000
Ecoclear 4500	Bioforce 4500uvc	Titan 3000
Ecoclear 9000	Bioforce 9000uvc	Titan 5500
Ecoclear 18000	Bioforce 18000uvc	Titan 12000



www.hozelock.com

P e r f e c t P o n d s M a d e S i m p l e



bioforce®

Revolutionary,
compact, effective pond
purifiers

For maximum pond sizes
up to 18000 litres (4000 gallons)

Bioforce presents a major advance
in pond filtration in effectiveness
and miniaturisation



In 2002 we introduced the Bioforce 18000UVC which is suitable for ponds up to 18000 litres (4000 gallons) and is, as such, the largest, most advanced pressurised pond filter on the market.

Many years of development and testing went into the Bioforce. Not only are we confident that it works very well but it has quickly become accepted as a winner in all levels of the trade.



Indeed development of the Bioforce range has been ongoing. Several new features have been introduced to the Bioforce to reduce and simplify maintenance, while enhancing the natural biological filtration process in the product.

It is a closed, pressure system holding more bacteria than a similar size normal filter. It is small enough to completely hide near the pond when it is buried up to its lid.

Being pressurised by the pond pump, water can be pumped up from the Bioforce to the top of a waterfall. This makes it much easier to hide.

Bioforce is ideal for pond keepers who want simplicity, clear water and an attractive hidden filter system.

Bioforce is available as a biological filter or combined biological filter and UVC. With the UVC, clear water is guaranteed if the correct size Bioforce is used.

The quartz tube used in the Bioforce allows 87% of the UV rays to pass through it to act on the algae. Plain glass and plastic only allow 30% and 50% of UV rays through them respectively.

Simple to install

It is best to use a Titan solids handling pump which moves solids from the pond to the Bioforce where they can be easily flushed away. Pond water is pumped up to the Bioforce which is buried up to its lid to hide it.

Water from the Bioforce can either be passed straight back into the pond or up to the top of a waterfall. A waterfall will increase aeration.

Easy to clean and maintain

- Layered foam disks of different coarseness ensure that water clarity can be achieved with minimum maintenance (excl. 1100).
- An automatic cleaning indicator lets the pondkeeper know when the foams need cleaning.
- Bayonet fitting of the electrical housing allows easy access for cleaning the quartz tube and main body.
- Bayonet fitting of quartz tube for easy lamp changing.

Bioforce 18000uvc

By developing the technology to couple two Bioforce 9000UVCs together, Hozelock Cyprio has introduced a Bioforce capable of treating ponds up to 18000 litres (4000 gallons) in size. Water enters through the central T-piece and into both units. Only one of the units has an operational by-pass feature. This ensures that one unit blocks up before the other, maximising the amount of time before the filter needs cleaning. When the cleaning indicator is activated both units need cleaning out.

Bioforce Performance Data

Model	Max Litres (Max Gallons)	Max Fish CM (Inches)	LPH (GPH)	UVC	Quartz Tube
1100	1100LTR (250GALS)	60 cm (2' 01")	550 LPH (125 GPH)	-	20 - 25 mm
1100UVC	1100LTR (250GALS)	60 cm (2' 01")	550 LPH (125 GPH)	5w	20 - 25 mm
2200	2200LTR (500GALS)	120 cm (4' 02")	1100 LPH (250 GPH)	-	20 - 25 mm
2200UVC	2200LTR (500GALS)	120 cm (4' 02")	1100 LPH (250 GPH)	5w	20 - 25 mm
4500	4500LTR (1000GALS)	240 cm (8' 04")	2250 LPH (500 GPH)	-	20 - 25 mm
4500UVC	4500LTR (1000GALS)	240 cm (8' 04")	2250 LPH (500 GPH)	9w	20 - 25 mm
9000	9000LTR (2000GALS)	480 cm (16' 08")	4500 LPH (1000 GPH)	-	20 - 40 mm
9000UVC	9000LTR (2000GALS)	480 cm (16' 08")	4500 LPH (1000 GPH)	11w	20 - 40 mm
18000UVC	18000LTR (4000GALS)	960 cm (31' 05")	9000 LPH (2000 GPH)	11w x 2	20 - 40 mm

Bioforce 1100/2200uvc

The system described below is used in the Bioforce 1100 and 2200UVC.

- 1 Water enters tangentially, spinning the water inside the Bioforce to settle out the solids.
- 2 Water is forced through an upper coarse foam disk and a lower fine grade disk (only one disk in the Bioforce 1100). Because the water is pressurised the foam can fill with many more beneficial bacteria without becoming blocked. It is this larger number of bacteria, taking pollutants out of the water, that make Bioforce so effective.
- 3 Water then passes close to the UV lamp, separated from it by a quartz glass sleeve. UV light makes algae clump together and sink to the bottom of the pond or get trapped in the Bioforce foam next time round.
- 4 When the Bioforce becomes blocked this red button will rise up. This signals that the foams need rinsing in pond water.

Bioforce 4500/9000/18000uvc

The system described below is used in the Bioforce 4500, 9000 and 18000UVC. These models feature enhanced biological action from the addition of plastic biomedia.

- 1 Water enters tangentially, spinning the water inside the Bioforce to settle out the solids.
- 2 The water is forced through three specially graded foams which catch particles and hold beneficial bacteria all the way through. This increases the performance of the unit and increases the time between cleaning.
- 3 Almost solids free, the water passes through plastic biomedia where more beneficial bacteria cleanse the pollutants.
- 4 Water then passes close to the UV lamp, separated from it by a quartz glass sleeve. UV light makes algae clump together and sink to the bottom of the pond or get trapped in the Bioforce foam next time round.
- 5 When the Bioforce becomes blocked this red button will rise up.

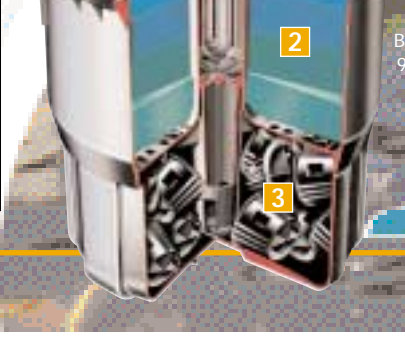
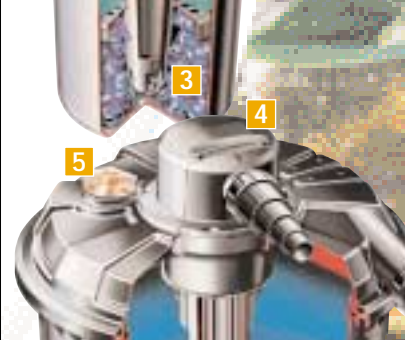
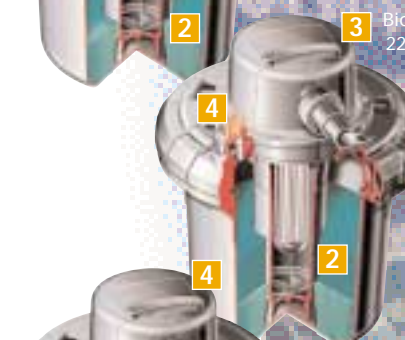
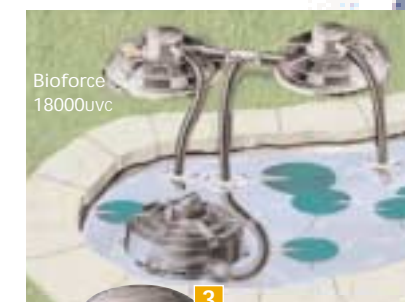

Part number	Description	Product Bar Code	Pack Qty
1301	Bioforce 1100	50 10646 03067 0	2
1302	Bioforce 2200	50 10646 03066 3	2
1303	Bioforce 4500	50 10646 03065 6	2
1304	Bioforce 9000	50 10646 02960 5	1
1311	Bioforce 1100uvc	50 10646 03064 9	2
1312	Bioforce 2200uvc	50 10646 03140 0	2
1313	Bioforce 4500uvc	50 10646 03142 4	2
1314	Bioforce 9000uvc	50 10646 02961 2	1
1335	Bioforce 18000uvc	50 10646 03598 9	1
1320	Bioforce 1100 Foam (Pre 2001)	50 10646 02838 7	2
1321	Bioforce 2200 Foam (Pre 2001)	50 10646 02839 4	2
1322	Bioforce 4500 Foam (Pre 2001)	50 10646 02840 0	2
1324	Bioforce 1100 Foam	50 10646 03577 4	2
1305	Bioforce 2200 Foam	50 10646 03578 1	2
1306	Bioforce 4500 Foam	50 10646 03579 8	2
1323	Bioforce 9000 Foam	50 10646 03221 6	2
1316	Bioforce 1100 Annual Service Kit (Pre 2001)	50 10646 02841 7	1
1317	Bioforce 2200 Annual Service Kit (Pre 2001)	50 10646 02842 4	1
1318	Bioforce 4500 Annual Service Kit (Pre 2001)	50 10646 02843 1	1
1336	Bioforce 1100 Annual Service Kit	50 10646 03563 7	1
1337	Bioforce 2200 Annual Service Kit	50 10646 03559 0	1
1338	Bioforce 4500 Annual Service Kit	50 10646 03574 3	1
1319	Bioforce 9000 Annual Service Kit	50 10646 03220 9	1
1523	Bioforce UVC 1100, 2200, 4500 quartz	50 10646 03436 4	1
1524	Bioforce UVC 9000, 18000 quartz	50 10646 03437 1	1
1527	Bioforce UVC 1100, 2200, 4500 quartz (Pre 2001)	50 10646 03209 4	1
1528	Bioforce UVC 9000 quartz (Pre 2001)	50 10646 03208 7	1



ecopower™

Combined filter and UVC

The affordable answer for clear and healthy water in garden ponds



Ecopower 2200
Ecopower 4500



The Ecopower is suitable for ponds up to 9000 litres (2000 gallons) and it is easy to disguise when positioned near the pond.

- 1 Water enters the unit and passes close to a UV-lamp, separated from it by a quartz sleeve. UV light makes algae clump together so it can be caught by the foam.
- 2 Water leaves the UV chamber via a spray head, which aerates the water for a high oxygen content.
- 3 Solid particles in the water are trapped on a foam sheet.
- 4 Almost solids free, the water passes through plastic biomedica where beneficial bacteria cleanse pollutants. The amount of biomedica contained in the filter increases in proportion to the size of filter/pond.
- 5 Clear healthy water then passes up an outlet tube and back into the pond.
- 6 Integral carry handles are positioned on the side of the filter to make the filter easy to lift if maintenance is required.
- 7 Viewing hatch to observe the internal operation of the filter, in particular whether any maintenance is needed.



ecomax™

Combined filter and UVC

A technologically advanced and highly efficient mechanical and biological filter for garden fish ponds

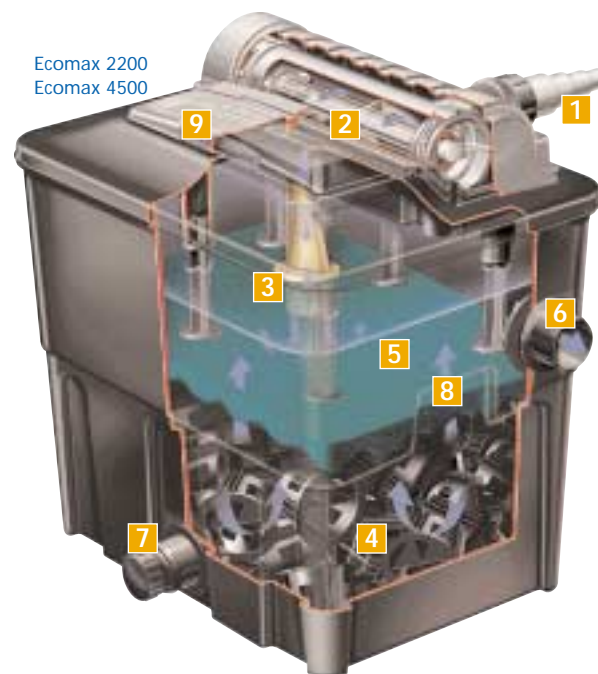

Ecomax 2200
Ecomax 4500

The Ecomax has been designed with advanced filtration technology for the pondkeeper who wants a crystal clear pollutant free pond.

- 1 Water enters the unit and passes close to a UV lamp, separated from it by a quartz sleeve. The UV light makes algae clump together so it can be caught by the foam.
- 2 In-built 'turbulator' - the flow of the water through the UVC, created by the product design, increases the unit's efficiency by even exposure of the water to the UV light and eliminates the possibility of air locks.
- 3 Water leaves the UV chamber via a venturi, which aerates the water for a high oxygen content. The venturi's position in the filter is very important - the water is oxygenated before it enters the biomedica, which significantly increases the effectiveness and activity of beneficial bacteria. This results in a highly efficient breakdown of harmful pollutants in the water.
- 4 The water passes through plastic biomedica where beneficial bacteria cleanse pollutants. The amount of biomedica contained in the filter has been scientifically measured and tested to ensure optimum biological filtration performance and increases in proportion to the size of filter/pond to support a greater number of fish.
- 5 A fine layer of foam traps any remaining solid particles.
- 6 Clear healthy water then passes back into the pond (via two outlets on the Ecomax 9000).
- 7 A drain is built in to flush out sludge, which collects at the bottom of the filter. The floor of the filter is sloped so sludge collects around the drain for easy removal.
- 8 Integral carry handles are positioned on the side of the filter to make the filter easy to lift if maintenance is required.
- 9 Viewing hatch to observe the internal operation of the filter, in particular whether any maintenance is needed.



Combination Filters Performance Data

Model	Max Litres (Max Gallons)	Max Fish CM (Inches)	LPH (GPH)	UVC	
Ecopower 2200uvc	2200LTR (500GALS)	79 cm (2' 08")	1100LPH (250GPH)	6w	20 - 25 mm
Ecomax 2200uvc	2200LTR (500GALS)	107 cm (3' 06")	1100LPH (250GPH)	6w	20 - 25 mm
Ecopower 4500uvc	4500LTR (1000GALS)	157 cm (5' 05")	2250LPH (500GPH)	8w	20 - 25 mm
Ecomax 4500uvc	4500LTR (1000GALS)	212 cm (6' 10")	2250LPH (500GPH)	8w	20 - 25 mm
Ecopower 9000uvc	9000LTR (2000GALS)	322 cm (10' 10")	4500LPH (1000GPH)	16w	40 mm
Ecomax 9000uvc	9000LTR (2000GALS)	435 cm (14' 03")	4500LPH (1000GPH)	16w	40 mm

Part number	Description	Product Bar Code	Pack Qty
1347	Ecopower 2200uvc	50 10646 03680 1	1
1348	Ecopower 4500uvc	50 10646 03681 8	1
1349	Ecopower 9000uvc	50 10646 03754 9	1
1363	Ecopower 2200 & 4500 Foam	50 10646 03828 7	2
1371	Ecopower 9000 Foam	50 10646 03830 0	2

Part number	Description	Product Bar Code	Pack Qty
1357	Ecomax 2200	50 10646 03682 5	1
1358	Ecomax 4500	50 10646 03683 2	1
1359	Ecomax 9000	50 10646 03684 9	1
1364	Ecomax Foam	50 10646 03829 4	2
1515	UV-lamp Combi Filter 6w	50 10646 04001 3	10
1516	UV-lamp Combi Filter 8w	50 10646 04002 0	10
1517	UV-lamp Combi Filter 16w	50 10646 04003 7	10





New for 2005

EasyClear™

Clearwater and Fountain Pump

Another innovation from Hozelock Cyprio that will drive and expand the aquatics market



www.hozelock.com

The EasyClear™ is a fully integrated unit that is positioned in the pond and guarantees the end user everything they want in terms of beautiful, clear and healthy water and an attractive and reliable fountain display. It has a 2 in 1 action:

1 Clear and healthy water

- The filter sieves out solids that make the water cloudy and makes the water healthy for fish and plants.
- The ultra violet clarifier eliminates green water.

2 Fountain

- The fountain creates a decorative display with a choice of three fountain heads.

Clearwater is guaranteed in ponds of up to 2000 litres capacity.

This product has been specifically designed to encourage small pond owners and the millions of potential pond owners to invest by overcoming the complexities of product selection and by making installation much easier.

Like all Hozelock Cyprio products the EasyClear™ has a multitude of features to make installation, operation and maintenance very simple.

Easy Installation

Everything is placed in the water so that there is no need for a filter system outside the pond which is difficult to disguise. Furthermore, only one electric cable and no hose connections makes installation very simple.

- 1 One power cable for simple and cost effective installation.
- 2 Ball joint for easy levelling of fountainhead.
- 3 Feet for stability.
- 4 Fountain stem extension segments for varying pond depths.

Easy Operation

- 5 3 Fountainheads (2 Tier, 3 Tier & Bell) for display choice.
- 6 Flow control to adjust size of fountain.
- 7 Fully integrated filter - UVC, mechanical and biological action.



EasyClear™ Performance Data

Max Fountain Height	Bell Jet Diameter	Max Litres (Max Gallons)	Max Fish CM (Inches)	UVC
0.60 m (2' 00")	0.35 m (1' 02")	2000LTR (440GALS)	0.72 m (2' 04")	5w



Easy maintenance

- 8 Latch for tool free access to filter foam for cleaning.
- 9 Anti-clog fountain strainer for low maintenance.
- 10 Bayonet fitting for easy access for lamp changing and cleaning.
- 11 Water bypass allows continued UVC and fountain operation if foam is blocked.

Easy to sell

The EasyClear™ is for small 'beginner's' ponds so sizing is easy. The display carton clearly shows that it is for a pond up to 2.5m x 1.5m x 0.5m deep.

Technical data

- 35 Watts.
- 10m Cable length.
- 5w UV lamp.

Accessories included

- 2 Tier jet.
- 3 Tier jet.
- Bell jet.
- 4 x fountain stem extension pieces.

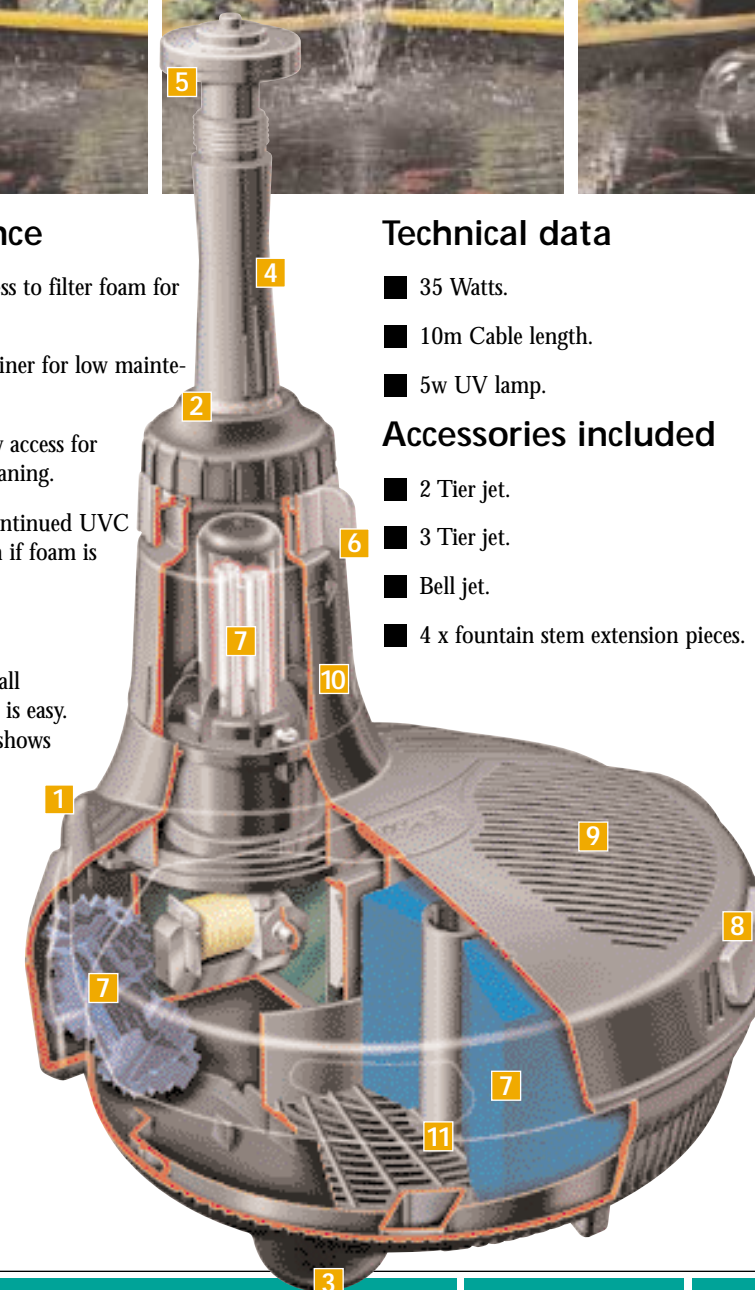

Part number	Description	Product Bar Code	Pack Qty
3327	EasyClear™ - 230v	50 10646 04078 5	2
3027	EasyClear™ LV	50 10646 04079 2	2
1519	Lamp 5w PLS TUV	87 11500 64248 6	10
1526	Quartz Tube	50 10646 04114 0	1
1372	EasyClear™ Foam	50 10646 04115 7	1
3418	Pump Impeller	50 10646 03581 0	5

P e r f e c t P o n d s M a d e S i m p l e



conventional filtration systems

Hozelock Cyprio was the originator of the three part conventional system for guaranteed clearwater. A simple trio of products, accurately sized for every pond up to 27,000 litres (6,000 gallons), perform a natural process to clear and purify pond water without chemicals.

Solids Handling Pump 1

The Titan or Prima XL solids handling pumps move polluting solids out of the pond into the filter where they can easily be removed.

Ultra Violet Clarifiers 2

Exceptionally effective Hozelock Cyprio Vorton Ultra Violet Clarifiers cause algae to clump together into groups too large to float. They either sink to the bottom of the pond and die or pass through the system to be removed by the biological filter foams.

Ecocel 9000

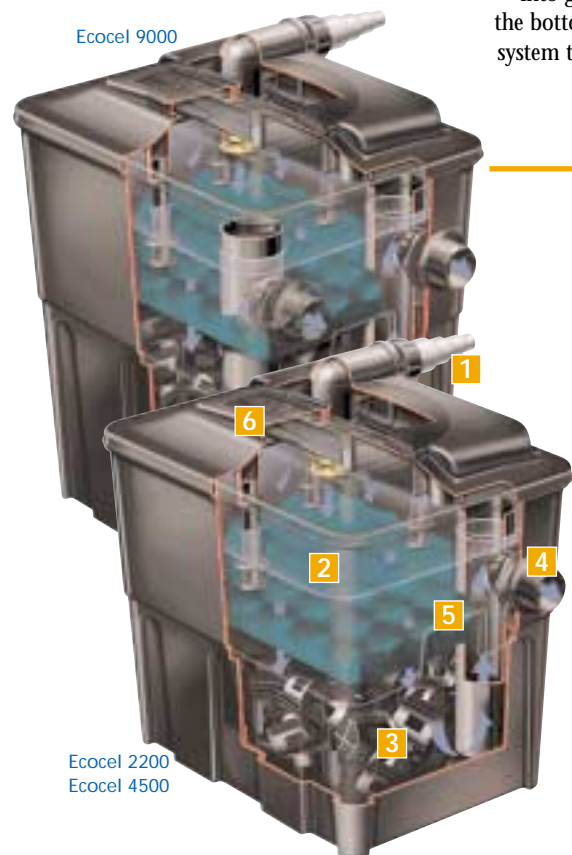

Ecocel 2200
Ecocel 4500

ecocel™

Biological pond filters

For ponds up to 9000 litres

When used with a Hozelock Cyprio UVC (see pages 20-21) the Ecocel carries the Clearwater Guarantee

Part number	Description	Product Bar Code	Pack Qty
3921	Ecocel 2200	50 10646 03685 6	1
3922	Ecocel 4500	50 10646 03686 3	1
3923	Ecocel 9000	50 10646 03687 0	1
1363	Ecocel 2200/4500 Foam	50 10646 03828 7	2
1371	Ecocel 9000 Foam	50 10646 03830 0	2



3 Biological Filters

Hozelock Cyprio Biological Filters serve two main purposes. Firstly they act as a mechanical strainer for debris and clumps of algae, removing these from the pond. Secondly they create a home for billions of beneficial bacteria which digest pollutants as the water passes over them. The biological filter contains media of very high surface area to create a habitat for very high concentrations of bacteria.

The whole pond volume should pass through the filter every two hours. The system should be run 24 hours a day to keep the bacteria supplied with pollutants.

Important too, is the quality design and engineering of these products based on the Hozelock Cyprio formula comparing pond size with water flow and amounts of biomedia used.

- 1 Water enters the unit via a spray head, which aerates the water for a high oxygen content.
- 2 Solid particles in the water are trapped in a foam sheet.
- 3 Almost solids free, the water passes through plastic biomedia where beneficial bacteria cleanse pollutants. The amount of biomedia contained in the filter increases in direct proportion to the size of the filter/pond to support a greater number of fish.
- 4 Purified water then passes up an outlet tube and back into the pond.
- 5 Integral carry handles are positioned on the side of the filter. To make the filter easy to lift if maintenance is required
- 6 Viewing hatch to observe the internal operation of the filter, in particular whether any maintenance is needed.

Conventional Filters Performance Data

Model	Max Litres (Max Gallons)	Max Fish CM (Inches)	LPH (GPH)	UVC	
Ecocel 2200	2200 LTR (500 GALS)	79 cm (2' 08")	1100 LPH (250 GPH)	Vorton 2200	20 - 25 mm
Ecocel 4500	4500 LTR (1000 GALS)	157 cm (5' 05")	2250 LPH (500 GPH)	Vorton 4500	20 - 25 mm
Ecocel 9000	9000 LTR (2000 GALS)	322 cm (10' 09")	4500 LPH (1000 GPH)	Vorton 9000	20 - 40 mm
GM 6500	6500 LTR (1500 GALS)	358 cm (12' 06")	3250 LPH (750 GPH)	Vorton 9000	12 - 25 mm
GM 11500	11500 LTR (2500 GALS)	633 cm (20' 10")	5750 LPH (1250 GPH)	Vorton 14000	20 - 40 mm
GM 18000	18000 LTR (4000 GALS)	990 cm (33' 04")	9000 LPH (2000 GPH)	Vorton 18000	20 - 40 mm
GM 27000	27000 LTR (6000 GALS)	1485 cm (50' 00")	13500 LPH (3000 GPH)	Vorton 27000	20 - 40 mm



Green Machines pack three filtration techniques into a compact box, brushes, foam cartridges and plastic biomedia

So Green Machines give ideal water for healthy fish and, with a Hozelock Cyprio UVC (positioned on the lid) guaranteed clear water too

How Green Machines are so effective

- 1 Pond water enters through an aerating spray bar.
- 2 Brushes separate out larger solids.
- 3 The foam cartridges are the first biological medium. Because they are only taking small solids they don't block easily.
- 4 Water passes down the centre of the foam cartridges, through plastic Biomedia in the lower compartment and back into the pond.

green machine®

The proven filtration systems for enthusiasts



Green Machine 11500

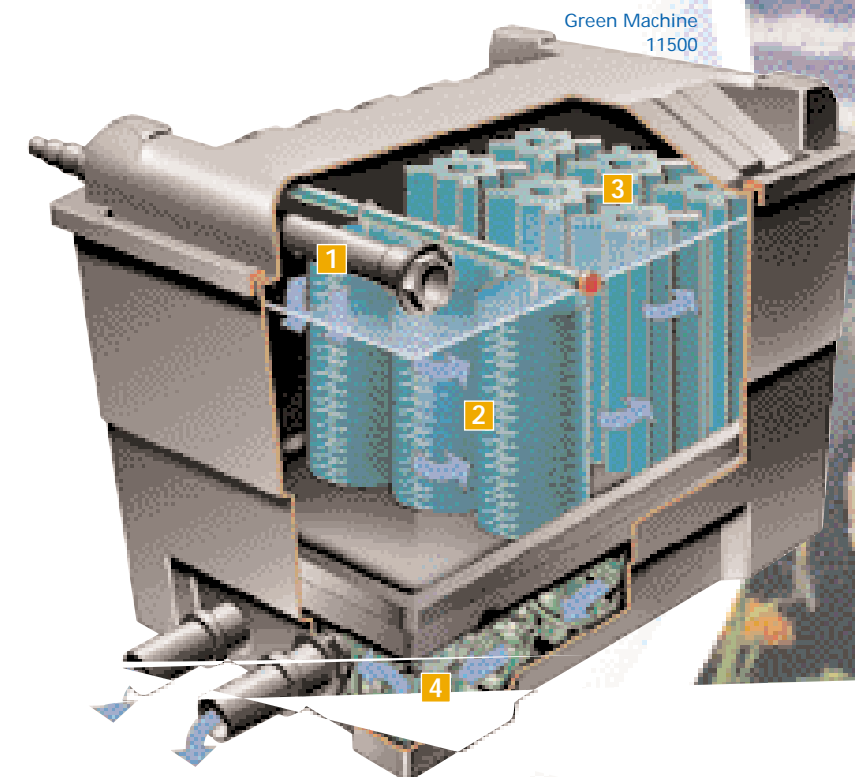

Part number	Description	Product Bar Code	Pack Qty
1350	Green Machine 6500	50 10646 03123 3	1
1351	Green Machine 11500	50 10646 03122 6	1
1352	Green Machine 18000	50 10646 03113 4	1
1353	Green Machine 27000	50 10646 03115 8	1



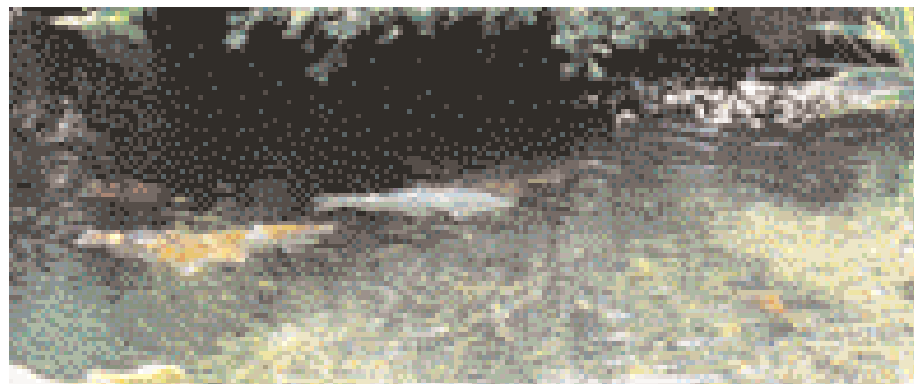

vorton™ ultra violet clarifiers

A revolution
in the efficient
elimination of green
water algae



The Ultra Violet Clarifier (UVC) continues to form a key element of a clearwater system. The algae, causing greenwater, are made to clump together (flocclulate) by the UV light so that they can be sieved out of the water by a filter. The introduction of the Vorton range has revolutionised UVCs with a list of features making them superior in performance, simple to install and extremely easy to clean and maintain.

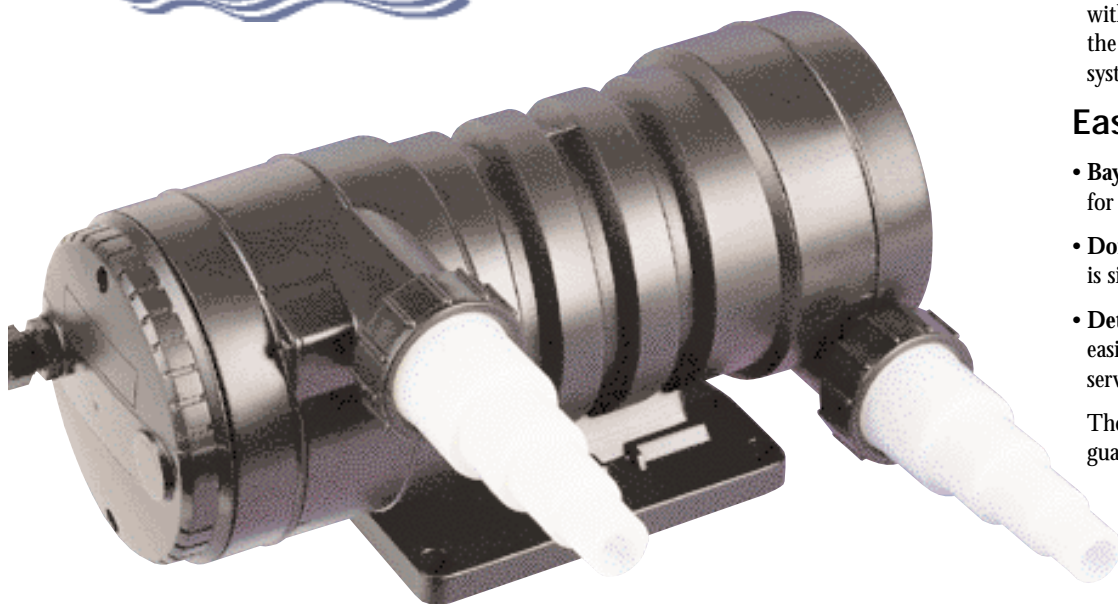

www.hozelock.com

Superior Performance

The new Vorton UVCs are up to 50% more efficient than many Ultra Violet Clarifiers on the market.

- **In-built "Turbulator"** - The flow of the water through the UVC, created by the product design, increases the units efficiency by even exposure of the water to the UV light and eliminate the possibility of air locks.

- **Single ended UV lamp** - The lamp design means 30% more UV light is emitted than a double ended lamp of the same wattage. These lamps also stay efficient up to 60% longer than double ended lamps, which means the lamp usually only has to be changed once a season.

- **Quartz tube** - Quartz allows 87% of the UV rays to pass through it and penetrate the water where it can act on the algae. Materials used in many other UVC units on the market such as plain glass and plastic only allow 30% and 50% of UV rays to pass through them respectively.

- **Operating temperature** - Careful product design ensures the UV lamps are kept within their optimum operating temperature range, which means that they are always working at their most efficient.

Simple to install

- **Multi-directional inlet/outlet** - Being able to rotate the inlet and outlet through up to 360° makes it much easier to route the hose to and from the unit.

- **Quick connect hose connections** - Joining up the pipework is simple, aiding installation and disconnection for cleaning and maintenance.

- **Translucent stepped hosetails** - The UV light causes the hosetails to glow clearly indicating when the lamp is operating.

The steps in the hosetails enable the correct diameter of hose to be attached to the UVC, so that they are working at their most efficient.

- **Extendable** - A tandem conversion kit is available with which two UVCs can be combined enabling the largest ponds to be treated or to enlarge the system if the size of a pond is increased.

Easy to clean and maintain

- **Bayonet fitting of electrical housing** - Easy access for cleaning the quartz tube and main body.

- **Dome ended quartz tube** - Cleaning and sealing is simple with only one open end.

- **Detachable mounting bracket** - The UVC can be easily removed from the mounting bracket to aid servicing and maintenance.

These highly durable units come with a 2 year guarantee (excluding the lamp).

Vorton UVC Performance Data

Model	Wattage	Max Litres (Max Gallons)	LPH (GPH)	Quartz Tube Length
2200	5w	2200LTR (500GALS)	1100 LPH (250GPH)	20 - 40 mm
4500	9w	4500LTR (1000GALS)	2200 LPH (500GPH)	20 - 40 mm
9000	11w	9000LTR (2000GALS)	4500 LPH (1000GPH)	20 - 40 mm
14000	11w	14000LTR (3000GALS)	7000 LPH (1500GPH)	20 - 40 mm
18000	2 x 9w	18000LTR (4000GALS)	9000 LPH (2000GPH)	20 - 40 mm
27000	2 x 11w	27000LTR (6000GALS)	13500 LPH (3000GPH)	20 - 40 mm

Clearwater Guarantee

When a HozeLOCK Cyprio "Vorton" UVC is used with a correctly sized HozeLOCK Cyprio biological filter, the system is covered by our Clearwater Guarantee.

Clarification vs Sterilisation

The HozeLOCK Cyprio UVCs are not sterilisers.

The problem with sterilising pond water is that the fish can lose their natural immunity to disease. If a fish is moved, or if a new diseased fish is introduced, the effect on the fish can be disastrous. HozeLOCK Cyprio UVCs are water clarifiers. Their job is to clear the water without potential side effects to animal life.

Accessories and spares

The UVC lamp should be replaced at the beginning of each season to maintain rated UV light output. 'O' rings, quartz sleeves and all other spare parts are available.

Safety

The whole UVC unit has an IP65 waterproof rating, and is designed for outside use.

Translucent hosetails mean that the lamp can be checked without dismantling the unit. The UVC is easily dismantled and even the quartz sleeve can be safely removed as a result of its simple bayonet fitting.

Part Number	Description	Product Bar Code	Pack Qty
1550	Vorton UVC 2200	50 10646 03418 0	2
1551	Vorton UVC 4500	50 10646 03419 7	2
1552	Vorton UVC 9000	50 10646 03421 0	2
1553	Vorton UVC 14000	50 10646 03420 3	2
1554	Vorton UVC 18000	50 10646 03422 7	2
1555	Vorton UVC 27000	50 10646 03423 4	2
1519	Lamp 5w PLS TUV	87 11500 64248 6	10
1520	Lamp 9w PLS TUV	87 11500 61824 5	10
1521	Lamp 11w PLS TUV	87 11500 62489 5	10
1523	Quartz Tube 2200/4500 (x2 for 18000)	50 10646 03436 4	1
1524	Quartz Tube 9000/14000 (x2 for 27000)	50 10646 03437 1	1
1522	UVC Annual Service Kit	50 10646 03438 8	1
1530	Quartz Tube 4500 (Pre 2001)	50 10646 03039 7	1
1531	Quartz Tube 9000 (Pre 2001)	50 10646 03040 3	1
1532	Quartz Tube 14000 (Pre 2001)	50 10646 03041 0	1
1533	Quartz Tube 18000 (Pre 2001)	50 10646 03042 7	1
1534	Quartz Tube 27000 (Pre 2001)	50 10646 03043 4	1
1537	Hosetails UVC Spare Set	50 10646 03049 6	1

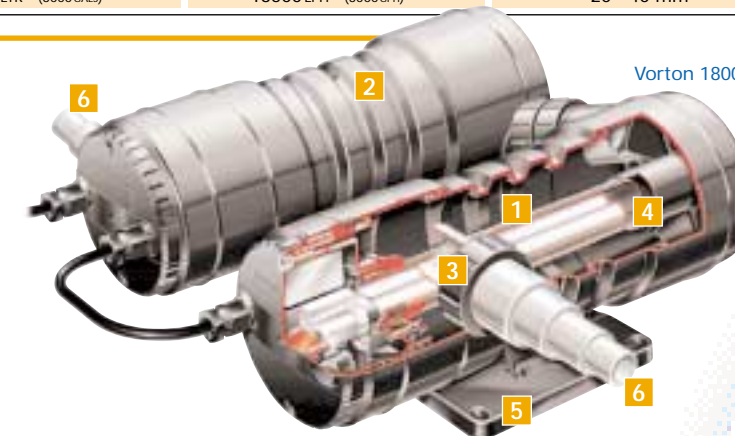

Vorton 18000

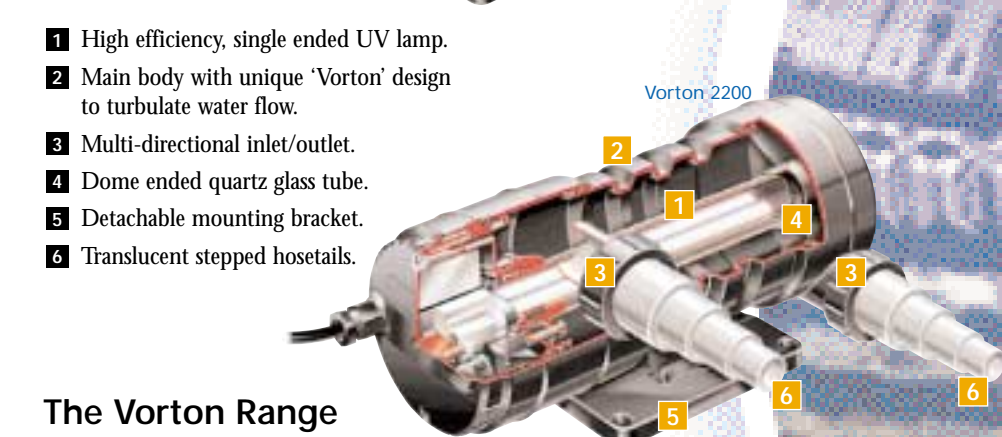

Vorton 2200

- 1 High efficiency, single ended UV lamp.
- 2 Main body with unique 'Vorton' design to turbulate water flow.
- 3 Multi-directional inlet/outlet.
- 4 Dome ended quartz glass tube.
- 5 Detachable mounting bracket.
- 6 Translucent stepped hosetails.

The Vorton Range

- Vorton 2200** - treats ponds of up to 2200 litres (500 gals) capacity
- Vorton 4500** - treats ponds of up to 4500 litres (1000 gals) capacity
- Vorton 9000** - treats ponds of up to 9000 litres (2000 gals) capacity
- Vorton 14000** - treats ponds of up to 14000 litres (3000 gals) capacity
- Vorton 18000** - treats ponds of up to 18000 litres (4000 gals) capacity
- Vorton 27000** - treats ponds of up to 27000 litres (6000 gals) capacity

P e r f e c t P o n d s M a d e S i m p l e



pond liners



Pond Liner Rolls

Lifetime guarantee. Made from 0.5mm thick PVC. Highly resistant to UV light, heat and cold. Available in 4 widths - 2m, 4m, 6m, and 8m. A self contained merchandising stand is available, suitable for both indoor and outdoor display.



Aqualin 15 Pre-packed Liners

This range of pre-packed liners is also available, to aid compact merchandising and customer self selection. These liners come with a 15 year guarantee and full installation instructions. They range from 2.5m x 2m (8'2" x 6'6") up to 6m x 4.5m (19'7" x 14'9").

Pond liner repair kit

A pond liner repair kit, suitable for use with synthetic plastic liners completes the range.

pre-formed ponds

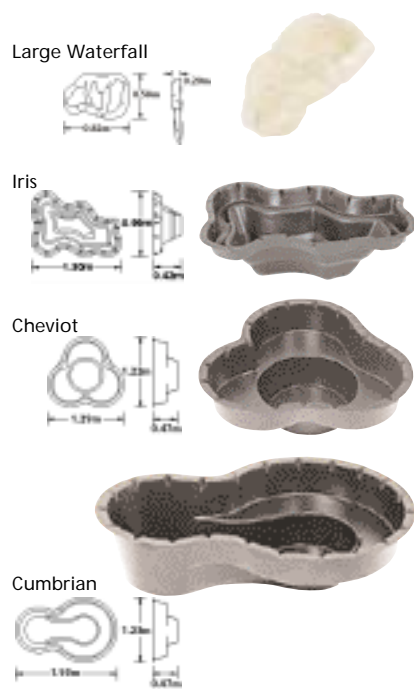

20 year guarantee due to use of high quality HDPE. Resistant to UV light, frost, stones and roots.

Our range of 3 pre-formed ponds will meet the needs of nearly all first time pond gardeners.

Iris - 3945

157 litres (35 gallons)

A small pond with planting margins

Cheviot - 3942

300 litres (65 gallons)

A symmetrical clover leaf

Cumbrian - 3944

480 litres (105 gallons)

A naturally curved, larger pond

All our ponds are deep enough to accommodate submersible pumps.

Waterfall - 3949

Made from high quality HDPE, they have a ten year guarantee.

Part Number	Description	Product Bar Code	Pack Qty
3432	Roll Liner - 25m x 2m	50 10646 93413 8	1
3434	Roll Liner - 25m x 4m	50 10646 93415 2	1
3436	Roll Liner - 25m x 6m	50 10646 93417 6	1
3438	Roll Liner - 25m x 8m	50 10646 93419 0	1
3460	Garden Pond Liner - 2.5m x 2m	50 10646 01832 6	1
3462	Garden Pond Liner - 4m x 3m	50 10646 01834 0	1
3465	Garden Pond Liner - 6m x 4.5m	50 10646 01837 1	1
3916	Pond Liner Repair Kit	50 10646 01445 8	5
3942	Cheviot - Pre-formed Pool	50 10646 01251 5	1
3944	Cumbrian - Pre-formed Pool	50 10646 01253 9	1
3945	Iris - Pre-formed Pool	50 10646 01254 6	1
3949	Waterfall	50 10646 01257 7	1

filter selection chart

		Max		Max Fish		Recommended Filter*	Recommended UVC**	Recommended Pump	Recommended Hose***	
		Litres	Galls	CM	Inches					
Compact Filtration	In Pond	2000	440	72	2' 04"	EasyClear™	-	-	-	
		Pressurised Filtration	1100	250	60	2' 01"	Bioforce 1100	-	Titan 2000****	25mm (1")
			1100	250	60	2' 01"	Bioforce 1100uvc	Included	Titan 2000****	25mm (1")
	2200		500	120	4' 02"	Bioforce 2200	-	Titan 2000	25mm (1")	
	2200		500	120	4' 02"	Bioforce 2200uvc	Included	Titan 2000	25mm (1")	
	4500		1000	240	8' 04"	Bioforce 4500	-	Titan 3000	25mm (1")	
	4500		1000	240	8' 04"	Bioforce 4500uvc	Included	Titan 3000	25mm (1")	
	Top Down Flow	9000	2000	480	16' 08"	Bioforce 9000	-	Titan 5500	40mm (1½")	
		9000	2000	480	16' 08"	Bioforce 9000uvc	Included	Titan 5500	40mm (1½")	
		18000	4000	960	31' 05"	Bioforce 18000uvc	Included	Titan 12000	40mm (1½")	
	Bottom Up Flow	2200	500	107	3' 06"	Ecomax 2200	Included	Titan 2000	25mm (1")	
		4500	1000	212	6' 10"	Ecomax 4500	Included	Titan 3000	25mm (1")	
9000		2000	435	14' 03"	Ecomax 9000	Included	Titan 5500	40mm (1½")		
Conventional Filtration	Above Ground	2200	500	79	2' 08"	Ecocel 2200	Vorton 2200	Titan 2000	25mm (1")	
		4500	1000	157	5' 05"	Ecocel 4500	Vorton 4500	Titan 3000	25mm (1")	
		6500	1500	358	12' 06"	Green Machine 6500	Vorton 9000	Titan 5500****	25mm (1")	
		9000	2000	322	10' 10"	Ecocel 9000	Vorton 9000	Titan 5500	40mm (1½")	
		11500	2500	633	20' 10"	Green Machine 11500	Vorton 14000	Titan 8000	40mm (1½")	
		18000	4000	990	33' 04"	Green Machine 18000	Vorton 18000	Titan 12000	40mm (1½")	
		27000	6000	1485	50' 00"	Green Machine 27000	Vorton 27000	PrimaXL 15000	40mm (1½")	

* Fish stocking level not more than 55cm per 1000 litres of pond volume (100" per 1000 gallons). Assumes fish at an average of 150mm (6") each.

** Where a choice of UVC is given, the larger model will result in more consistent clarity.

*** For guidance only. Actual flow varies according to length of hose, keep runs as short as possible.

**** An in-line flow adjuster may be required.

conventional filter spares & accessories

Part Number	Description	Product Bar Code	Pack Qty
1776	Biofloc 2200 Foam Set	50 10646 02969 8	1
1777	Biofloc 4500 Foam Set	50 10646 02977 3	1
1778	Biofloc 9000 Foam Set	50 10646 02976 6	1
1779	Biozorb 2200 Foam Set	50 10646 02975 9	1
1780	Biozorb 4500 Foam Set	50 10646 02974 2	1
1781	Biozorb 9000 Foam Set	50 10646 02970 4	1
1782	Biozorb 14000 Foam Set	50 10646 02971 1	1
1783	Biozorb 23000 Foam Set	50 10646 02972 8	1
1784	Biozorb 32000 Foam Set	50 10646 02973 5	1
1785	Biocartridges - Green Machine 6500	50 10646 02993 3	1
1786	Biocartridges - Green Machine 11500	50 10646 02996 4	1
1787	Biocartridges - Pro Filter Models	50 10646 03000 7	1
1788	Biocartridges - Green Machine 18000	50 10646 02999 5	1
1789	Biocartridges - Green Machine 27000	50 10646 04004 4	1
1790	Green Machine 6500 Brushes - 4" diameter (Green)	50 10646 03012 0	1
1791	Green Machine 11500 Brushes - 4" diameter (Pre 98 Green)	50 10646 03013 7	1
1792	Green Machine 18000 - GGM 16000 Brush (Pre 98 Green)	50 10646 03014 4	1
1794	Green Machine 11500 Brushes - 6" diameter x 10" (Green)	50 10646 03016 8	1
1795	Green Machine 18000/27000 Brush (Green)	50 10646 03017 5	1
1798	Green Machine 27000-GGM 23000 Brush (Pre 98 Red)	50 10646 03020 5	1
1799	Green Machine 27000 Brushes - 6" diameter x 12" (Green)	50 10646 04005 1	1
1800	Cyprapak Media - 1m³	50 10646 02853 0	1
1801	Cyprapak Media - 200 litres	50 10646 02852 3	1
1770	Budget 2200 Foam Set unpunched	50 10646 02978 0	1
1771	Budget 4500 Foam Set unpunched	50 10646 02979 7	1
1772	Budget 9000 Foam Set unpunched	50 10646 02980 3	1



www.hozelock.com

P e r f e c t P o n d s M a d e S i m p l e



aqua-glow™

Proven in-pond lighting system

Low voltage (24v) pond lights that can be used in a variety of ways



Part Number	Description	Product Bar Code	Pack Qty
3560	Aqua-glow Pond Light 3 Lamp Starter Set	50 10646 01096 2	2
3565	Aqua-glow Single Pond Light	50 10646 01095 5	2
3510	Pond Light Lens - Clear	50 10646 01105 1	5
3511	Pond Light Lens - Red	50 10646 01106 8	5
3512	Pond Light Lens - Green	50 10646 01107 5	5
3513	Pond Light Lens - Blue	50 10646 01108 2	5
3514	Pond Light Lens - Amber	50 10646 01109 1	5
3590	Spare Bulbs	50 10646 00935 5	10
3595	Low Voltage Cable - 7.5m (25ft)	50 10646 00936 2	5
3592	Low Voltage Cable - 15m (50ft)	50 10646 00937 9	5

Hozelock Cyprio in-pond lights can be placed at the bottom of the pond, floating on the water surface, or fixed on top of the pump

So lighting effects can be obtained wherever they are needed

Safe

Because the system is low voltage, it does not represent a danger in the garden or pond.

Durable

The Hozelock Cyprio in-pond lighting system is produced to a high quality design, based upon our experience of outdoor electrical products. All components carry a 2 year guarantee. (Except for lamps).

Simple to Install

A transformer is included in the three light set.

As the system works off a 24v low voltage supply, installation is simple and does not require a qualified electrician.

The low voltage cable can be either camouflaged or buried. Cable lengths of up to 50 metres can be accommodated.

Five different lens colours are available as accessories so that a variety of effects can be achieved.

A full range of accessories, such as extra cable and connectors is available, to enable the system to be added to. The in-pond lighting system is fully compatible with the Hozelock Decorative Garden Lighting range. This further enhances the flexibility and economy of the system.

Added flexibility of single light

Up to three extra lights can be run as an addition from the transformer for the 3-light set.

This enables extra lighting to be obtained simply and cheaply.



pebble fountain water feature

Suits any garden or patio and easy to install

Kit includes Cascade 700 fountain pump



Integral hinged lid makes the water feature easy to install and maintain. Only one lid segment needs to be opened to access pump once installed, which avoids having to remove pebbles from the entire lid. Lid can bear a load of 20kg.

Three recessed planting pockets are moulded into the outer rim. These pockets can be covered with lids provided, if they are not required.

With a capacity of 21 litres, the water feature needs less frequent topping up, even in hot weather.

A sludge trap at the base of the reservoir protects the pump.

A merchandiser is available for easy in-store stacking of the pebble fountain.



Choice of fountain

The Cascade 700 pump comes with a choice of three fountain patterns

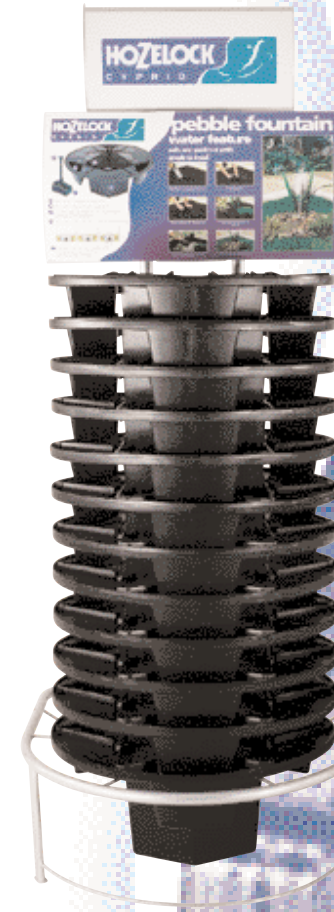

Part Number	Description	Product Bar Code	Pack Qty
3583	Pebble Fountain Water Feature - inc. pump	50 10646 03613 9	13



www.hozelock.com

P e r f e c t P o n d s M a d e S i m p l e



pond treatments, fish food and test kits

Fish food

Highly digestible due to high levels of top quality protein. Hozelock Cyprio fish food has good wetting properties, floats well and will not cloud water. A range of Sticks, Flake and Koi food pellets are available.

Hozelock Cyprio Nutri-stick is available in three sizes - 110g, 220g and 500g.

Hozelock Cyprio Nutri-flake is available in three sizes - 100g, 200g and 500g.

Hozelock Cyprio Nutri-Koi is special because it contains canthaxanthin to bring out the colour in the fish. It also has fifteen vitamins, six minerals and is 98% digestible. Consequently, it can be used in water temperatures as low as 8°C. It is available in three sizes - 400g, 900g and 1.5kg.



Part number	Description	Product Bar Code	Pack Qty
3450	Nutri Stik - 110g	50 10646 01551 6	6
3451	Nutri Stik - 220g	50 10646 01552 3	2
3452	Nutri Stik - 500g	50 10646 01553 0	2
3453	Nutri Koi - 400g	50 10646 01554 7	6
3454	Nutri Koi - 900g	50 10646 01555 4	2
3455	Nutri Koi - 1.5kg	50 10646 01556 1	2
3457	Nutri Flake - 100g	50 10646 01557 8	6
3458	Nutri Flake - 200g	50 10646 01558 5	2
3459	Nutri Flake - 500g	50 10646 01559 2	2
3961	Ammonia and pH Test Kit	50 10646 02965 0	6
3485	Water Feature Treatment - 250ml	50 10646 02911 7	6
3981	Pond Sludge Remover	50 10646 01179 2	6
3965	Green Water Treatment - 250ml	50 10646 01173 0	6
3966	Tap water Conditioner - 250ml	50 10646 01174 7	6
3969	Pond Stabiliser	50 10646 01177 8	6
3967	Anti Fungus and Bacteria - 250ml	50 10646 01175 4	6
3968	Anti Parasite - 250ml	50 10646 01176 1	6
3959	Blanketweed Treatment - 250g	50 10646 03645 0	6

Pond Treatments

Hozelock Cyprio pond treatments complement our pumps, filters and UVCs to help keep ponds healthy and crystal clear

All products are harmless to pond wildlife. Test kits include integral viewing window, stirrer and comprehensive guide to pond management.



The range includes:

- 3959 Blanketweed Treatment** - eliminates blanketweed fast.
- 3485 Water Feature Treatment** - A biological product which keeps enclosed water features clear of algae.
- 3981 Pond Sludge Remover** - to reduce filter maintenance
- 3965 Green Water Treatment** - to clump floating algae so that filters can remove them more easily
- 3966 Tap Water Treatment** - neutralises chlorine
- 3967 Anti-Fungus and Bacteria** - treats most common fish diseases
- 3968 Anti-Parasite** - treats common parasitic problems in fish.
- 3969 Pond Stabiliser** - controls blanketweed.
- 3961 Ammonia and pH Test Kit**



cypriflexTM pond hose & hose fittings

Hozelock Cyprio filtration systems are class leading and the all new Cypriflex pond hose complements these products by being simply the best pond hose available. Cypriflex hose is also ideal for all types of waterfall installation. Made from high quality plastics this spiral hose is extremely flexible with every size of hose capable of a bend radius only 3 times its diameter without kinking or splitting. Furthermore the exceptionally smooth bore ensures minimal flow restriction.

Available in five diameters; 12mm (1/2"), 20mm (3/4"), 25mm (1"), 32mm (1 1/4"), 40mm (1 1/2").

New Hose Merchandiser

To complement the new Cypriflex hose, a merchandiser is available that allows for inside or outside displays. The hose packaging allows easy loading of the merchandiser which enables simple dispensing and measurement of the hose.

Hose clips

The zinc plated hose clips come with a foam strip to ensure maximum grip to the exterior of Cypriflex hose. They have a wing tightener for easy tool free adjustment. In five sizes to fit Cypriflex hose.

Hose fittings

Hozelock Cyprio offers a complete range of hose fittings and accessories to enable the construction of all sorts of pump and filtration systems. Available in 12.5mm (1/2") size up to 40mm (1 1/2")



Part number	Description	Product Bar Code	Pack Qty
1700	Cypriflex Hose 50m - 12mm	50 10646 03025 0	1 x 50m
1701	Cypriflex Hose 50m - 20mm	50 10646 03030 4	1 x 50m
1702	Cypriflex Hose 30m - 25mm	50 10646 03026 7	1 x 30m
1703	Cypriflex Hose 30m - 32mm	50 10646 03027 4	1 x 30m
1704	Cypriflex Hose 25m - 40mm	50 10646 03028 1	1 x 25m
1710	Winged Hoseclip Zinc - 12mm	50 10646 03175 2	6
1711	Winged Hoseclip Zinc - 20mm	50 10646 03171 4	6
1712	Winged Hoseclip Zinc - 25mm	50 10646 03172 1	6
1713	Winged Hoseclip Zinc - 32mm	50 10646 03173 8	6
1714	Winged Hoseclip Zinc - 40mm	50 10646 03174 5	6
3997	Union Hose Connector - 12mm	50 10646 01198 3	5
3998	Union Hose Connector - 20mm	50 10646 01199 0	5
3999	Union Hose Connector - 25mm	50 10646 01200 3	5
1718	Union Hose Connector - 32mm	50 10646 03170 7	6
1719	Union Hose Connector - 40mm	50 10646 03169 1	6
1728	Small Universal Tee	50 10646 03182 0	6
1729	Large Universal Tee	50 10646 03181 3	6
1436	Quick Release Connector - 20,25,32,40mm	50 10646 03260 5	5
1666	Reducing Hose Connector - 12mm x 10mm	50 10646 03196 7	5
1667	Reducing Hose Connector - 12mm x 20mm	50 10646 03195 0	5
1668	Reducing Hose Connector - 25mm x 12mm	50 10646 03194 3	5
1669	Reducing Hose Connector - 25mm x 20mm	50 10646 03193 6	5
1670	Reducing Hose Connector - 32mm x 20mm	50 10646 03192 9	5
3995	Hose Tap Flow Control - 20mm	50 10646 01195 2	5
3996	Hose Tap Flow Control - 25mm	50 10646 01197 6	5
1427	Stepped Hosetail (1 1/4" BSP - M)	50 10646 03106 6	1
1428	Stepped Hosetail (3/4" BSP - F) inc. Washer	50 10646 03107 3	1
1434	Stepped Hosetail (1 1/2" BSP - M)	50 10646 03262 9	1
1435	Stepped Hosetail (3/4" BSP - M)	50 10646 03261 2	1





Cyprivac

Weatherproof Cable Connector

Planting Baskets

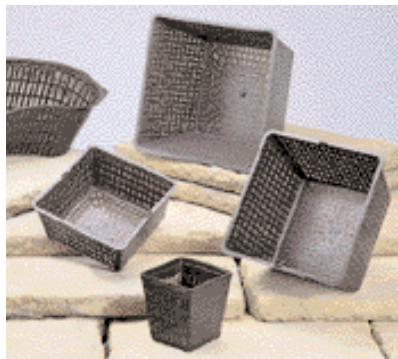

Pool Nets

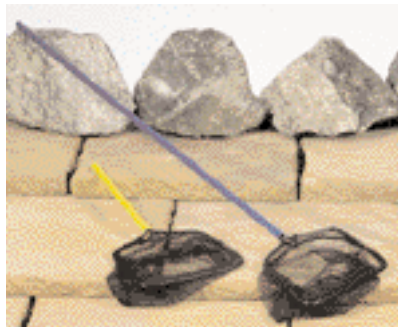

pond accessories

Weatherproof Cable Connector

Fully weatherproof (IP68) for outside use with cable from 6mm to 8mm diameter. NOT TO BE USED UNDER WATER

Planting Baskets

Range of sizes and shapes. Fine mesh to prevent loss of compost. No hessian lining required. Range includes:

Square baskets

- Small, medium and large - Marginal plants.
- 3970 - 90mm x 200mm x 200mm
- 3971 - 140mm x 240mm x 240mm
- 3972 - 190mm x 290mm x 290mm
- 3474 - 110mm x 110mm x 110mm

Curved basket

- For larger plants.
- 3973 - 460mm x 170mm x 150mm

Pool nets

300mm handle & 800mm handle.

Pond Vacuum

Cyprivac

Even the best designed ponds can suffer 'dead spots' where waste matter can collect.

With a simple manual pump action, Cyprivac will suck up small solids for disposal. You may also need it to clean much of the debris from a heavily polluted pond before a filter system is installed.

This is better than emptying the pond, cleaning and filling with new water.

Spare parts

After 2 or 3 years of constant use the filter foams will need replacing and these are readily available.

Should your customers lose, or break any parts these can be ordered from Hozelock Cyprio.

It is important to keep spare parts for at least your best selling Hozelock Cyprio filters and UVCs in stock, particularly in the spring.



pioneers in category management

Hozelock Cyprio has pioneered the introduction of the latest category management techniques to the aquatics market, significantly increasing demand for our pump and filtration system programmes.

Focusing on studies of consumer behaviour at point of sale and research into the consumer purchase process, we deliver merchandising solutions that maximise sales. Units such as the Clearwater Centre and Pump Flow Displays guide consumers through an understanding of the product function, the benefits of the Hozelock Cyprio range and selecting the right product for their specific application.

Our approach through category management is the same as our product design. We offer the consumer

'perfect ponds made simple'



Part number	Description	Product Bar Code	Pack Qty
3970	Pond Planting Basket - Small	50 10646 01040 5	10
3971	Pond Planting Basket - Medium	50 10646 01039 9	10
3972	Pond Planting Basket - Large	50 10646 01038 2	10
3973	Pond Planting Basket - Curved	50 10646 01442 7	10
3474	Marginal Square Basket	50 10646 01927 9	10
3909	Weatherproof Cable Connector	50 10646 01183 9	1
3985	Short Reach Pool Net	50 10646 01450 2	5
3986	Medium Reach Pool Net	50 10646 01451 9	5
1750	Cypri-Vac Manual Pond Vacuum	50 10646 03052 6	1
1751	Cypri-Vac Annual Service Kit	50 10646 03053 3	1



P e r f e c t P o n d s M a d e S i m p l e

