

LED LITE™
Energy Saving LED

10W Ultra Slim LED Floodlight with PIR Sensor

LTUSF10PIR

- IP65 Body / IP44 PIR sensor rating
- Additional wall mounting bracket
- Flexible installation:
 - 360° light rotation
 - 180° tiltable
- Waterproof connection box included
- Wide 120° beam angle
- Up to 10m detection range PIR
- Pulse override facility

The new LTUSF10PIR are maintenance free exterior/interior energy saving LED Floodlight, with an ultra slim design and additional bracket for 360° light orientation. It offers high flexibility in installation and the possibility to rotate the floodlight in any desired direction even after installation.

It comes in two versions - Warm White (3000K) and Cool White(6500K), with an IP65 rating for the body and IP44 rating for the PIR sensor.

Applications include: Gardens, Bushes/Shrubs, Security Lighting, Porch Lighting and Area Floodlighting, Site Lighting

Floodlight Specifications:

- Voltage Range: 220-240V
- Nom. Watts: 10W
- Lumen Output: 820lm(WW - 3000K)
850lm (CW - 6500K)
- Beam Angle: 120°
- IP Rating: IP65 Body / IP44 PIR sensor
- Warranty: 3 Years
- Die Cast Aluminium Casing
- Shatter Resistant Tempered Glass
- Not Dimmable
- With Waterproof Connection Box
- Includes additional Wall Mounting bracket
- Optional Garden Spike(not included)

PIR Sensor Specifications:

- Up to 10m Detection Range
- Time adjustment: 5sec. - 10min.
- Lux adjustment: 5 ~ 2000lux
- Detection Angle: 140°
- Pulse Override Facility



Waterproof connection box

Additional wall mounting bracket





Dimensions:

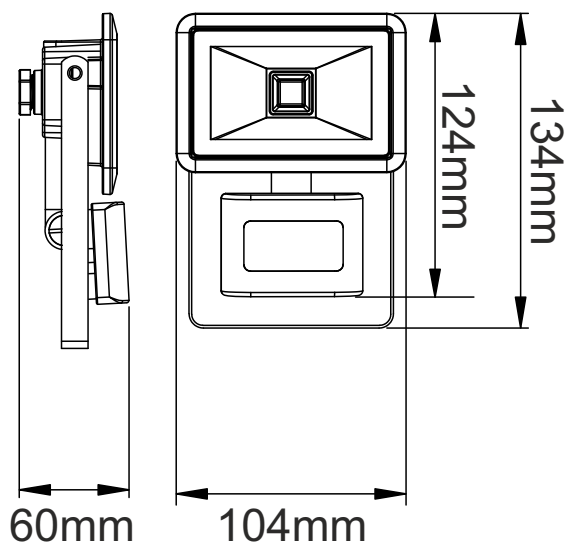

Easy Installation:

The additional round wall bracket is detachable and can be mounted to the surface before the rest of the floodlight. The floodlight can be attached simply on the wall bracket with screws for a easy and flexible installation. See steps below:

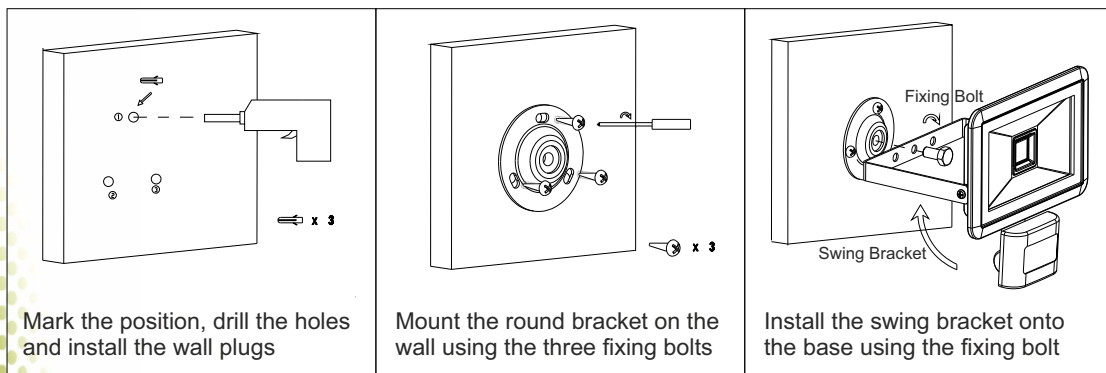

PIR Coverage Range:

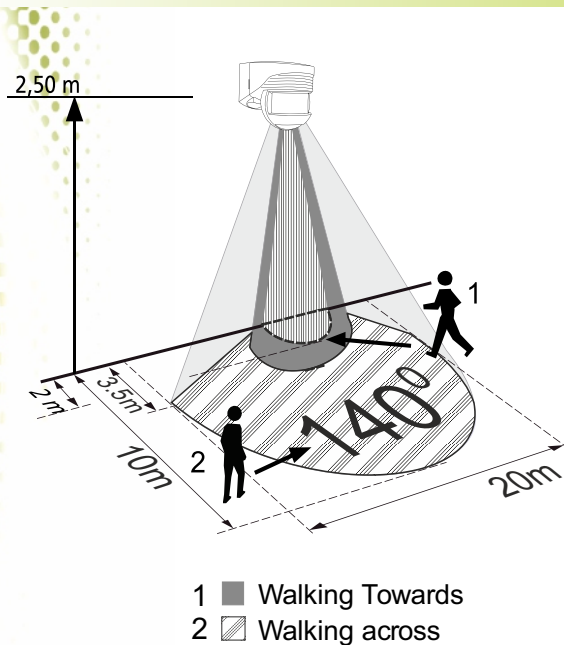

Wiring Information:

Connection Box	220-240V Input
	Brown = Live
	Blue = Neutral
	Green/Yellow = Earth

