





LTTD10WIFI

10W Smart Wifi CCT Changeable
LED Fire Rated Downlight

Works with Amazon Alexa
and Google Assistant

Works with the Google Assistant  

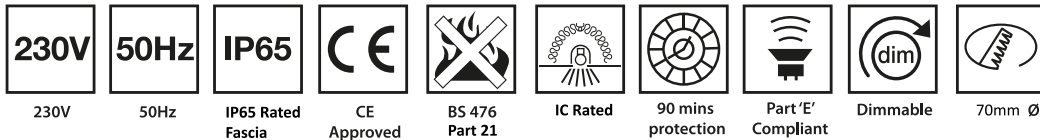

General Instructions

These instructions should be read carefully and retain after installation for further reference and maintenance.



SCAN THE QR CODE to download the APP or search "Smart Life" on your App Store or Android Market by Mobile Phone.

Important information

It is recommended that luminaires are installed by a qualified electrician ensuring the installation complies to current IEE wiring regulations & local building control.

- These products are designed for connection to a 230-240V mains supply.
- Before installation or maintenance ensure that the mains supply to the luminaire is switched off and the circuit supply fuses are removed or circuit breaker turned off.
- Check that the total load on the circuit, including when this luminaire is fitted, does not exceed the rating of the circuit cable, fuse or circuit breaker.
- We will not accept responsibility for any claims arising from a poor installation.
- Suitable for bathroom and shower room use.

Specifications:

- App Control: 2.4Ghz WiFi using Smart Life APP
- Compatible with Amazon Alexa & Google Home
- APP Light Control:
 - ON/OFF
 - Dimming
 - CCT Changing
 - Grouping
 - Timer/Schedule
- Dimmable: Yes, through the APP (5-100%)
- 30, 60 and 90 min Solid Joist and I-Joist Fire Rated
- IC Rated
- IP Rating: IP65
- Housing Material: Aluminium + PC
- Voltage: 220-240V
- Frequency: 50/60Hz
- Power: 10W
- Lumen Output: up to 750lm
- Colour Changeable: 2000-6500K
- CRI: >80
- Power factor: >0.5
- Beam Angle: 60°
- Cut-Out: 70mm
- Loop In/Out connector
- 20cm cable between downlight and driver
- Interchangeable Magnetic Bezels available (White included)

Dimensions:

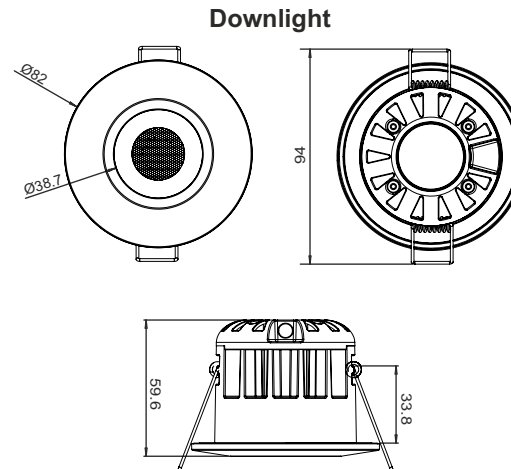

Driver

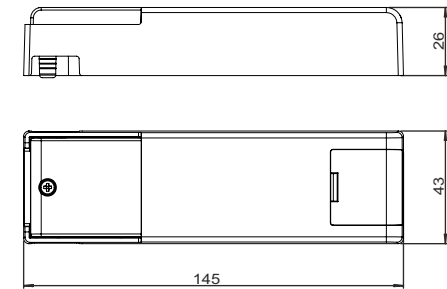

Installation:

- Cut a suitable hole in the ceiling as per the cut-out details ensuring it does not infringe with electrical cables, water/gas pipes or ceiling joists. (see Fig.1).
- The lamp is IC Rated and designed for use with insulated material so that it does not need extra IC cage accessories.
- Connect the mains supply to the downlight (see Fig.2).
- Fit the downlight into the hole (see Fig.3) in the ceiling with the 2 spring clips supplied (see Fig.4).
- Test for correct operation.
- Control the downlight using the phone APP (see next page for instructions).



SAFETY FIRST
• BEFORE STARTING ANY ELECTRICAL WORK ALWAYS SWITCH OFF AT THE MAINS
• IF IN DOUBT CONSULT A QUALIFIED ELECTRICIAN

Fig 1.
Cut mounting hole in the ceiling 70mm diameter.

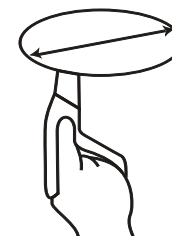

Fig 2.
Connect mains supply to downlight

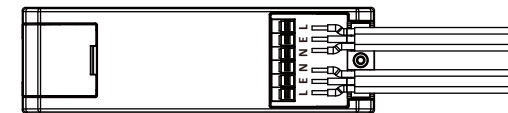

Fig 3.
Fold spring clips upwards and insert fitting into hole

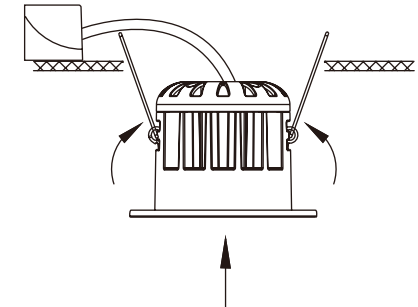
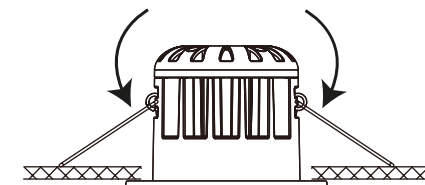
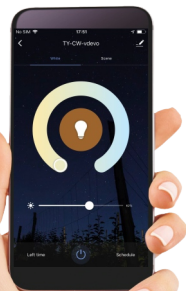

Fig 4.
Release the spring clips to hold the fitting in place.





NO.1 Download the Smart Life APP

Scan the QR code present on the packaging box or in the instructions to download the APP. You can also search "Smart Life" in either App Store or Google Play to install the APP.

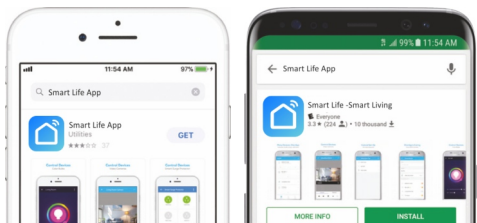

Note: This item works only on a 2.4GHz WiFi network, not on a 5GHz WiFi network. Please consult the manual of your router for settings.

NO.2 Login/Registration

After downloading the free Smart Life App from Apple Store or Play Store create a new account by following these steps:

1. Press "Login"
2. Select Your country code, enter the e-mail address or phone number you want to use to login and press "Obtain verification code"
3. Enter the code received by e-mail or phone, set your personal password and press "Completed". Now you can access the pages for the creation of your Smart Home.

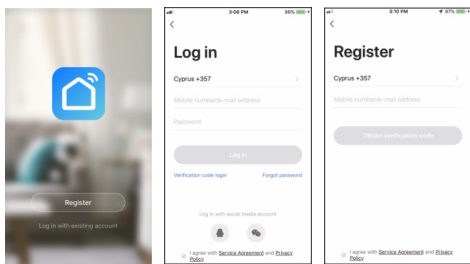

NO.4 Add New Device - EZ Procedure

Make sure your new device is in EZ mode, otherwise reset it by switching on the light and, after 10 seconds, switching it off then on 3 times. The light will start blinking quickly (about 3 times per second).

After resetting the device:

1. Press "Confirm light blinks rapidly" (Pic.1). A new page will open (Pic.2).
2. Enter the password of the WiFi network you are connected to and press "OK" to connect. The WiFi network supported is 2.4GHz (disable the 5GHz WiFi network).



Pic.1

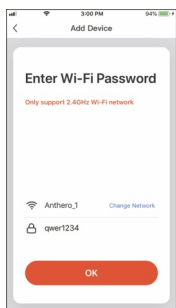

Pic.2

NO.5 Add New Device - EZ Procedure

When connecting the device, you can see the connection status as shown in Picture 3. Once connected, a page will open as shown in Picture 4.

Select the location of the device in your smart home and press "Completed" to access the control page of your new device.

Now your new light is ready to be controlled via the APP, even remotely.

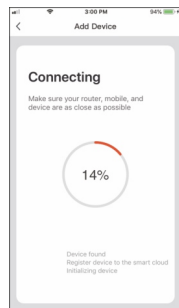

Pic.3

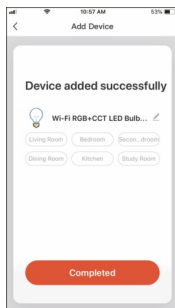

Pic.4

NO.6 Connection Failed

If the Application shows the page as in Picture 5, it means that the light connection has failed. By pressing "Got it" you can try to connect it again in EZ mode or select the AP Mode by pressing on the top right as shown in Picture 6.

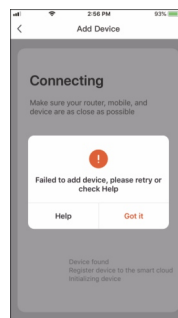

Pic.5

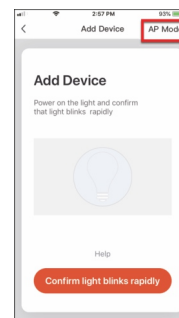

Pic.6

NO.8 Device Control

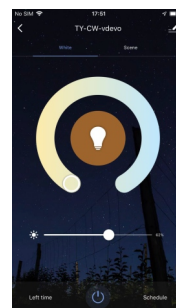

After connecting the device, the control page will be opened automatically.

Here you can do the following:

- Change the colour of the white, from warm white to cool white.
- Dim the light.
- Select one of the scenes already created for you.
- Use Schedule to program the switching on and off at predefined times.

NO.10 Creation of Scenarios and Automations

You can create an infinite number of Scenarios and Automations enabling other devices to interact with each other.

By pressing "Smart" at the bottom centre of the home page and then "+" in the upper right corner, you can choose whether to add a new scenario or a new automation.

- A **Scenario** is a set of commands assigned to the various devices that will be activated simultaneously whenever you click on the created scenario or in the days and hours programmed.
- An **Automation** is the execution of a specific command given to a device when a specific condition has been activated.

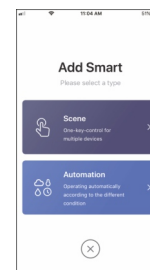
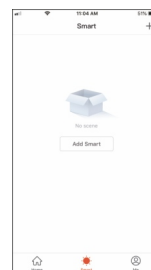

NO.12 Sharing Devices

You can share your devices with your family and friends who have downloaded the Smart Live APP and have a registered account. The people you share your devices with will be able to control them, but they will not be able to add new devices to your home or delete any devices shared with them. You have two different ways to share your devices:

- Enter the page of your profile, press "Home Management" and "Share Devices" to enter the page where you can select the devices you want to share. Enter the e-mail address used in the Smart Life APP by the user you want to share the devices with. If you want to delete sharing with a user, place your finger on the user's name, drag to the left and then press "Delete".
- Enter the menu of the device you want to add, press "Shared Devices" and enter the e-mail address used in the Smart Life APP by the user you want to share the devices with. If you want to delete sharing with a user, place your finger on the user's name, drag to the left and then press "Delete".

NO.7 Add New Device - AP Procedure

To connect the device in AP mode switch the light on and, after 10 seconds, switching it off then on 3 times until it flashes quickly (about 3 times per second). Continue switching the light off then on 3 times and it will start flashing slowly (about once every 3 seconds). At this point press "Confirm light slowly blink" (Pic.7), enter the password of the WiFi network you are connected to, press "OK" (Pic.8) and you will open the page as shown in Picture 9. By pressing "Go connect" your mobile phone will take you to the WiFi Setting page. Select the "Smartlife-XXX" network, go back to the Smart Life APP and your new device will connect correctly.

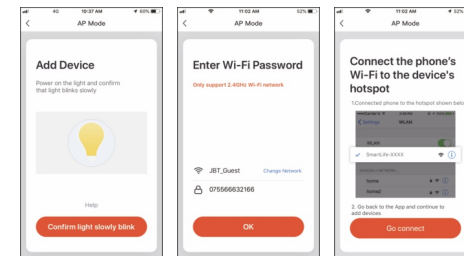

Pic.7

Pic.8

Pic.9

NO.9 Device Menu

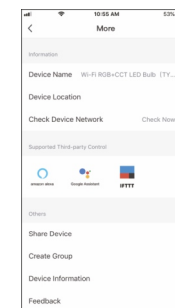

By pressing on the menu symbol at the top right you can:

- Change the name of your device.
- Select the location of the device in your home.
- Check how to connect it to your voice control device (Google Home or Amazon Alexa).
- Share control of the device with other family members or friends.
- Create a group of multiple devices so that you can control them together.
- Update the device firmware.
- Remove the device.

NO.11 Profile

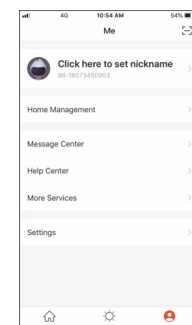

"Me" is the page where you can change your settings:

1. Your Profile.
2. Home Management.
3. Message Centre.
4. Additional services, such as the list of devices that can be associated with the application (Google Home, Amazon Alexa) in order to control your home via voice commands.
5. Settings to activate push notifications and other features.