

The Quinetic wireless controller with a high-efficiency switching power supply has a wide voltage range with excellent stability and durability. The QR303 controller has a load capacity of 6A relay. It is equipped with an in-rush current suppression function, creating a safe and durable product.

The Quinetic controller offers lighting solutions for workshops & sheds, listed buildings, conservatories, assisted living & many other applications.

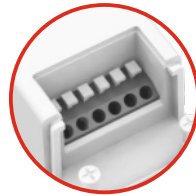

**NEW**  
Integrated  
Push-in Terminals

### Line Diagram

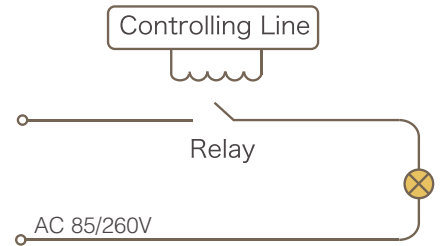

## QR303

### QR303 - 6A Quinetic Receiving Controller Specifications:

Product Code: QR303  
 Voltage range: 85-260V 50/60Hz  
 Working environment temperature: -25°C - 50°C  
 Control distance\*: 160m(outdoor), 30m(indoor)  
 Capacity: Up to 10 switches can be paired with one controller  
 Control method: pairing with Quinetic Wireless Switch  
 Communication: FSK (under 1000Mhz)  
 Sensitivity: -116dB  
**Integrated push-in terminals for quicker installation**

Control Load: 6A  
 Maximum Load: 500W LED  
 1100W other loads\*\*  
 Life Time: 200,000 times on/off  
 Weight: 25g

\*Distance comes from Quinetic laboratory test results. The actual distance in practical use might vary due to environmental difference.

\*\*Maximum load rating may vary depending on manufacturers specifications.

### Wiring Instructions :

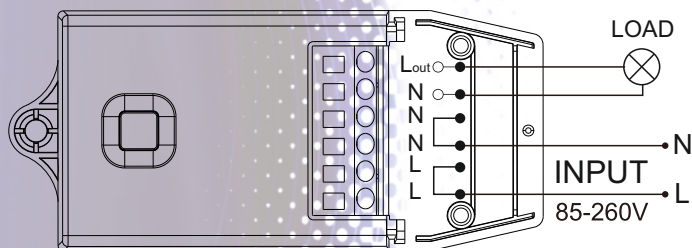

L: Live In  
 N: Neutral Line  
 Lout: Live Out

### Dimensions:

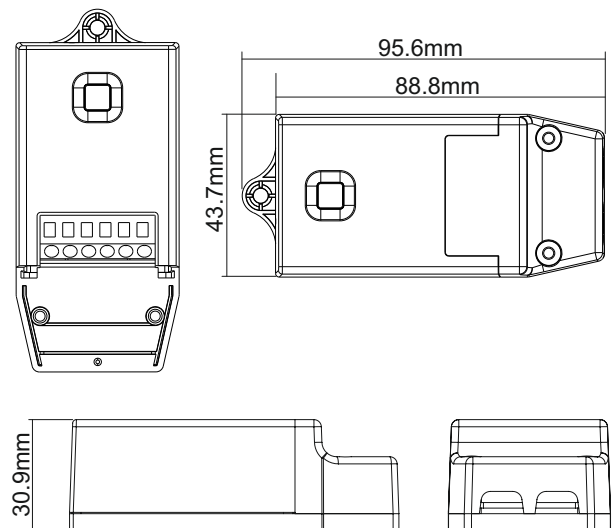

# Quinetic Controller Wireless Systems

The wireless Quinetic energy switch and wireless receiving controller can be paired with any combination: a controller can be controlled by a maximum of 10 separate switches, a switch can pair an unlimited number of controllers.

## 1-Way Wireless System Single-Multi-Control

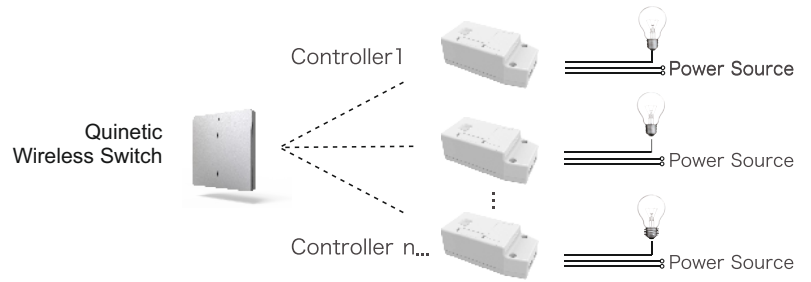

## 2-Way Wireless System Dual Control

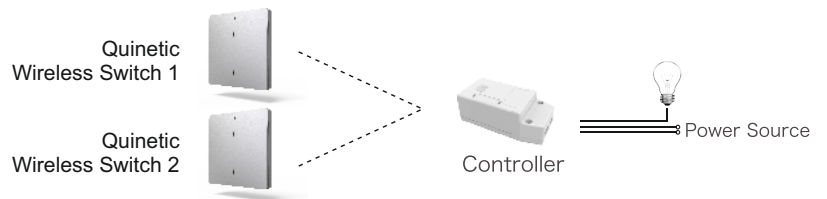

## 3-Way Wireless System Multi-Single-Control

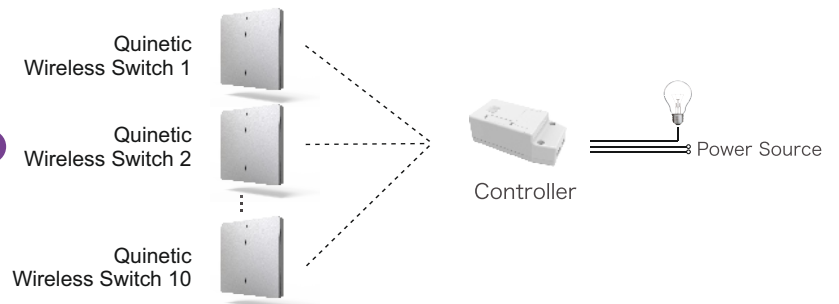

# Limitless Applications

The Quinetic Wireless Switch can be installed or placed nearly anywhere. Glass, marble, ceramic tile and other smooth surfaced flat walls such as normal lime walls and painted walls. The possibilities are endless.

