

TIMEGUARD®

7 Day Digital Programmer 2 Channel – Surface Mount

Model: TRT036N



Installation & Operating Instructions

1. General Information

These instructions should be read carefully and retained for further reference and maintenance.

2. Safety

- Before installation or maintenance, ensure the mains supply to the Programmer is switched off and the circuit supply fuses are removed or the circuit breaker turned off.
- It is recommended that a qualified electrician is consulted or used for the installation of this Programmer and install in accordance with the current IEE wiring and Building Regulations.
- Check that the total load on the circuit including when this Programmer is fitted does not exceed the rating of the circuit cable, fuse or circuit breaker.
- To clean use a clean dry cloth only. Do not use any liquid cleaners.

3. Technical Specifications

- 230V AC 50 Hz
- This thermostat is of Class II Construction and must not be earthed
- Switch Rating: 3(1)A
- Switch Type: Single pole, double throw (SPDT) for both heating and hot water, change over contacts
- Connection Type: 3 wire
- Installation Type: Surface mount with wall plate
- Micro Disconnection: Type 1.B control action
- Operating Temperature Range: 0°C to +40°C
- Programme: 5 day plus 2, or 7 day set by DIP switches
- Pumped or Gravity Operation: System P or System G set by DIP switches
- Time Control Periods: 3 per day with copy function
- Clock Format: 12 hour AM/PM or 24 hour
- Summer/Winter Changeover: Day light saving, GMT or BST
- Holiday Mode: 0 to 31 day program suspension
- Boost Function: 1, 2 or 3 hour for both heating and hot water

- Battery Backup: 7 day, factory fitted rechargeable (non-replaceable)
- Illumination: Blue LED illuminated on setting for button surrounds and display
- CE Compliant
- Dimensions (H x W x D): 90 x 135 x 30mm

TRT036N Front View

12hr am/pm or 24hr clock timer display (illuminated on setting)

Display light/Holiday mode setting button

1, 2 and 3 hour heating boost function (illuminates on setting)

The heating symbol will show when heat is demanded for both channels

Flip down cover conceals setting buttons

Advance to next Programme, ON/OFF override and copy function

Up down selection buttons

1, 2 and 3 hour hot water boost function (illuminates on setting)

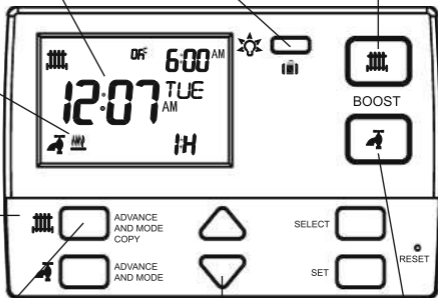

4. Siting

- The TRT036N should be located at a position which eases wiring runs and gives good access for programming.
- It should be mounted approximately 1.5m above floor level.

5. Installation

- 5.1 Ensure the mains supply is switched off and the circuit supply fuses are removed or the circuit breaker turned off.
- 5.2 Remove the wall plate from the unit, by undoing the retaining screws, and pivoting the bottom of the unit outwards. The TRT036N body can then be lifted off.
- 5.3 Mark the position of the mounting holes on the wall using the wall plate as a template. Drill out the mounting holes taking care to avoid any joists, electrical cables or water/gas pipes that may be hidden beneath the surface. Insert the rawl plugs into the holes.
- 5.4 Pass the 230V 50Hz mains supply and load cables through the opening of the wall plate. Allow sufficient excess cable to wire up the unit, but not too much to make it difficult to close the unit to the wall plate.
- 5.5 Fix the wall plate to the wall using the correct mounting screws for the rawl plugs installed. The retaining screws which secure the unit to the wall plate should be at the bottom.
- 5.6 Terminate the cables into the terminal block ensuring correct polarity is observed and that all bare conductors are sleeved (See section 6. Connection Diagram). Make sure that the curved washer grips the conductor.
- 5.7 To reinstall the unit onto the wall plate, first ensure the wall plate retaining screws are loosened enough to clear the TRT036N body, then engage the top of the TRT036N onto the wall plate retaining tabs, and push firmly downwards and then upwards. There will be some resistance from the terminals.
- 5.8 Once in place, secure with the retaining screws making sure not to over tighten.

TRT036N Wall Plate

Alternate mounting holes

Retaining tabs

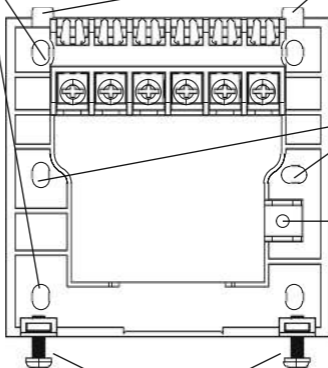

Mounting holes

Loop terminal

Wall plate retaining screws

6. Connection Diagram

Connect the 230V 50Hz mains supply and load cables to the terminal block which are marked as follows;

- **Note: Check boiler instructions before connecting.**

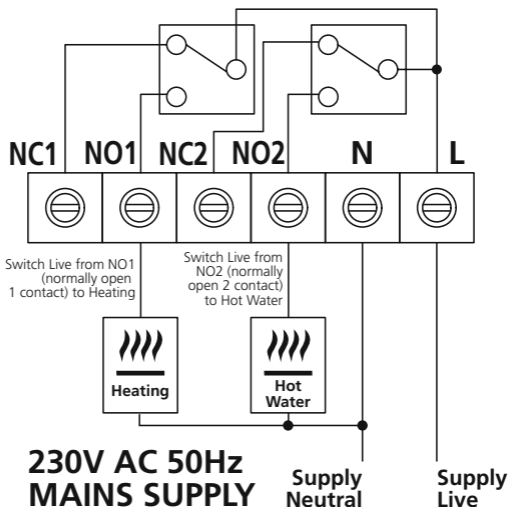

230V 50Hz Mains Supply

Live Supply (Brown or Red) to

L

Neutral Supply (Blue or Black) to

N

A 'Loop Terminal' is provided should a 3 core cable be used

Load (Boiler)

Switch Live, Central Heating (Brown or Red) to

NO1

Switch Live, Hot Water (Brown or Red) to

NO2

7. DIP Switch Settings

- Decide whether weekday/weekend (5-2) or individual (7) day programming is required, and set the DIP switches in the correct position on the rear of the unit. A reset will be required after changing the DIP switch positions.
- You can set the TRT036N to run a Pumped or Gravity system. It is important to check which system you have before setting the DIP switches and operation. This can also be set using the DIP switches located on the rear of the unit.

System P is for Pumped – this will allow different programmes for both central heating and hot water.

System G is for Gravity – hot water has to follow the central heating programmes at all times, this will also be true when in boost or advance modes.

TRT036N Rear of Unit

DIP switches for 5-2 or 7 day programming
and System P/System G operation

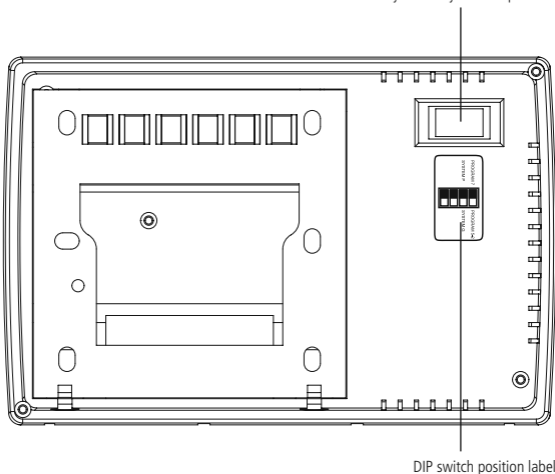

8. Reset from Power-up

- Restore mains to the unit after making sure to check all system wiring is complete, and after you have selected the desired DIP switch settings.
- Press the reset button located beneath the flip down cover on the front of the unit, all of the characters will briefly appear on the display, followed by the 12hr clock format screen.

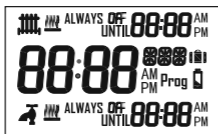

- After 1 minute the screen will time out showing a default time of 12:00AM.
- There are 3 timed controlled periods per day, and the default Programmes are as follows;

Heating (HTG)

06:00AM ON

08:00AM OFF

10:00AM ON

12:00PM OFF

06:00PM ON

10:00PM OFF

7

9. Setting the Time and Date

- 9.1 To alter the time and date at any time, press and hold the Select button for 3 seconds, the display light will illuminate.

SELECT



- 9.2 The default clock format is 12Hr which will be displayed on the screen.



- 9.3 Use the Up/Down arrow buttons to either select 24Hr format, or leave it at 12Hr format, and then press the Select button once to confirm.

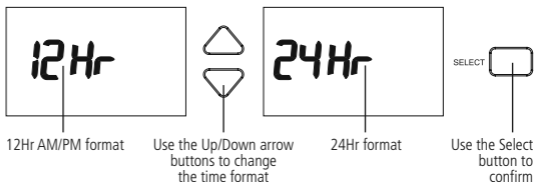

- 9.4 The hour will flash, use the Up/Down arrow buttons to alter the hour and press the Select button once to confirm.

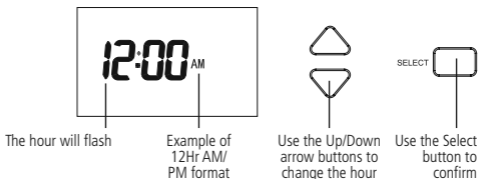

- 9.5 The minutes will flash, use the Up/Down arrow buttons to alter the minutes and press the Select button once to confirm.

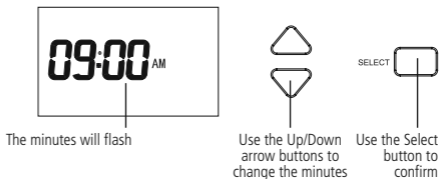

- 9.6 The year will flash, use the Up/Down arrow buttons to alter the year and press the Select button once to confirm.

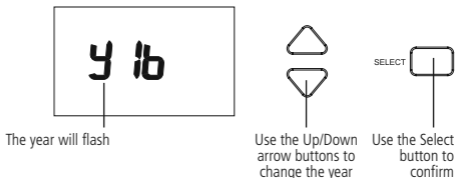

- 9.7 The month will flash, use the Up/Down arrow buttons to alter the year and press the Select button once to confirm.

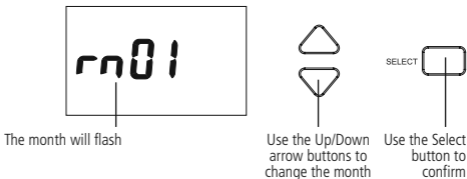

- 9.8 The day will flash, use the Up/Down arrow buttons to alter the day and press the Select button once to confirm.

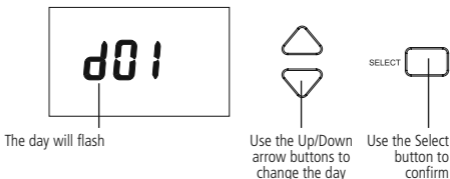

- 9.9 The daylight saving option (GMT=OFF/BST=ON) will flash, by default this will be set to OFF. Use the Up/Down arrow buttons to alter the setting. Press the Select button once to confirm and return to re-enter the date and time from the beginning, or press the Set button once to confirm and exit.

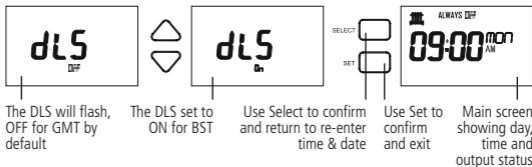

Note:

- If no button is pressed, it will time out after 60 seconds and return to the mains screen showing day, time and output status.
- The display light will also time out after 15 seconds after the last button is pressed.
- The Set button can be pressed to exit the date and time entry at any stage.

10. Programme Entry

Note:

- If you have selected weekday/weekend (5-2) Programming via the DIP switches (see section 7. DIP Switch Settings) you will be able to group Monday – Friday for the same ON and OFF times, and then group Saturday – Sunday for the same ON and OFF times.
- If you have selected individual (7) day Programming via the DIP switches, then you will need to set ON and OFF times for each day of the week, Monday through to Sunday, for each day you require.
- The Copy function can be used to duplicate ON and OFF times for different days of the week, as detailed further in the instructions (read the instructions in full before you begin).

The following steps use the individual (7) day Programming as an example. The steps for weekday/weekend (5-2) Programming are the same, except you will be able to select either M – F (Monday to Friday grouped) or S – S (Saturday and Sunday grouped), instead of individual days.

- 10.1 Press and hold the Set button for 3 seconds to enter the Programming mode, the display light will illuminate.

SET



- 10.2 The Day of the week will flash (e.g. Mon), use the Up/Down arrow buttons if you need to choose a different day of the week, and then press the Select button once to confirm.

Mon will flash
when selected



Use the Up/Down arrow
buttons to change the
day of the week



Use the Select
button to confirm

- 10.3 The heating (HTG) icon will start to flash with the hot water (HW) remaining solid. Use the Up/Down arrow buttons to change the channel you wish to program, the chosen icon is the flashing one, and press the Select button once to confirm.



The heating (HTG) icon will flash meaning it is selected and ready to be programmed



Use the Up/Down arrow buttons if you wish to change this to hot water, and the hot water (HW) icon will flash

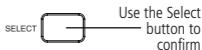

Use the Select button to confirm

- 10.4 The P1 ON (Programme 1 ON) hour will flash, use the Up/Down arrow button to choose the hour and press the Select button once to confirm.



The hour will flash

Heating (HTG) icon indicating the heating channel is being programmed



Use the Up/Down arrow buttons to change the hour



Use the Select button to confirm

- 10.5 The minutes will flash, use the Up/Down arrow button to choose the minutes and press the Select button once to confirm.
- 10.6 The P1 OFF (Programme 1 OFF) hour will flash, use the Up/Down arrow button to choose the hour and press the Select button once to confirm.
- 10.7 The minutes will flash, use the Up/Down arrow button to choose the minutes and press the Select button once to confirm.
- 10.8 The P2 ON (Programme 2 ON) hour will flash. Follow steps '10.3' to '10.6' for P2 (Programme 2 ON and OFF) and also P3 (Programme 3 ON and OFF).
- 10.9 Press the Set button once to change the day of the week (e.g. Tue). Use the Up/Down Arrows to choose the day of the week, and press the Select button once to confirm.
- 10.10 Follow steps '10.3' to '10.9' until you have Programmed each day of the week that you require.
- 10.11 Press the Set button twice to exit the Programme entry.

SET



Note:

- If no button is pressed, it will time out after 60 seconds and return to the mains screen showing day, time and output status.
- The display light will also time out after 15 seconds after the last button is pressed.
- All 3 time controlled periods will need to be Programmed, unwanted times need to be entered as the same time i.e. P2 ON 7:00AM, P2 OFF 7:00AM. P3 ON 7:00AM, P3 OFF 7:00AM.
- Unwanted days of the week need to be entered as the same time i.e. Wed P1-P2-P3 ON 7:00AM, P1-P2-P3 OFF 7:00AM. Thu P1-P2-P3 ON 7:00AM, P1-P2-P3 OFF 7:00AM etc.
- The Set button can be pressed twice to exit the programme entry at any stage.

Copy Function

Note:

- The copy function can only be used after you have programmed at least one day, for both channels.
- You cannot copy programs for individual channels i.e. if you have different program set for heating and hot water for Mon for example, both programs for each channel will get copied to the day of your selection at the same time, they cannot be split.

10.12 From the main screen, press and hold the Set button for 3 seconds, so the day of the week is flashing e.g. Mon (or if you are already in the programming screen, press Set once so the day flashes).

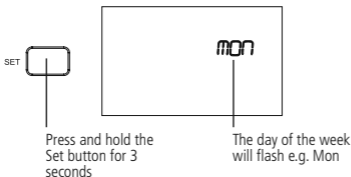

- 10.13 Press the Advance and Mode Copy button once. Use the Up/Down arrow button to choose the day of the week you wish to copy, and press the Select button once.

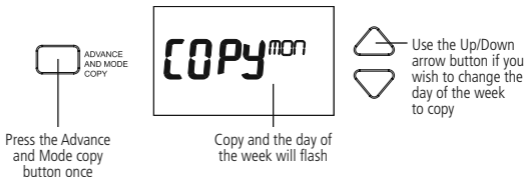

- 10.14 Use the Up/Down arrow buttons to choose the day of the week you wish to copy the Programme to e.g. Tue, and press the Select button once to confirm.

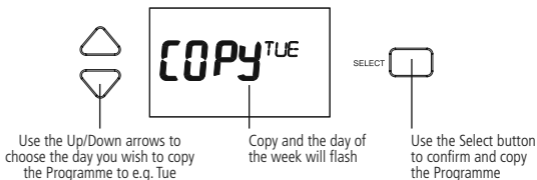

- 10.15 Use the Up/Down arrow buttons to choose the next day of the week you wish to copy the Programme to e.g. Wed, and press the Select button once to confirm.

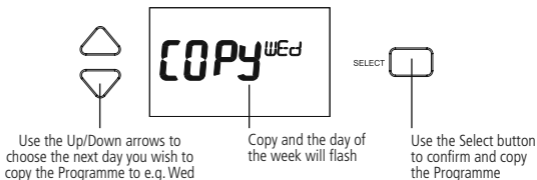

- 10.16 Repeat step 10.15 until you have copied the programme to all of the days of the week that are required.

- 10.17 Press the Set button twice to exit the programme entry.

Note:

- If no button is pressed, it will time out after 60 seconds and return to the mains screen showing day, time and output status.
- The display light will also time out after 15 seconds after the last button is pressed.
- The Set button can be pressed twice to exit the copy function at any stage.

11. Operation

Programme Modes

- There are 4 Programme modes available. You can cycle through all 4 Programme modes by pressing the Advance and Mode Copy button.

The output status will be as follows;



ADVANCE
AND MODE

Press the Hot Water Advance and Mode Copy button, to cycle through the 4 program modes.



ADVANCE
AND MODE
COPY

Press the Heating Advance and Mode Copy button, to cycle through the 4 program modes.

Always OFF



Permanent OFF

Always ON



Permanent ON

OFF until next ON



OFF until next
programmed ON

ON until next OFF

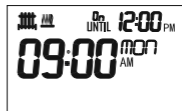

ON until next
programmed OFF

Boost Function

- The boost options are 1 hour, 2 hours, 3 hours and 0 hours to cancel.
- Press the Boost button once for 1 hour, the display light will illuminate as well as the Boost button surround. While setting, and during the boost period, the On flashes ON and OFF.

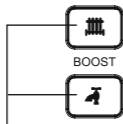

Press the Boost button for either, or both the, heating and hot water. The button surrounds will illuminate

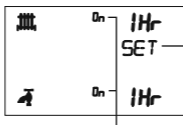

On will flash ON and OFF whilst setting, and during the boost period

The display light will illuminate and 1hr SET will appear on the screen

- A second press of the Boost button will increase the timed period to 2 hours, a third press for 3 hours and a fourth press for 0 hours, which will cancel the boost timed period and return you to normal operation.

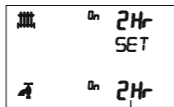

2 presses of the Boost button for 2 hours

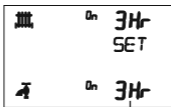

3 presses of the Boost button for 3 hours

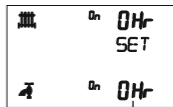

4 presses of the Boost button to either channel for 0 hours to cancel the boost timed period

- The boost setting will time out after 15 seconds, and the display light will turn OFF. The Boost button surround will remain illuminated whilst active.

Display showing 2hr boost periods with On flashing after the boost setting times out



Display showing normal operation when boosts are cancelled

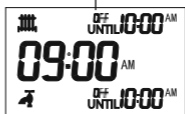

The Boost button surrounds will remain illuminated whilst active



Display Light/Holiday Button

- Pressing the Display light/Holiday button once illuminates the display for 15 seconds.



- Any key press will illuminate the screen also, with a 15 second time out after the last button press.
- Any time the back light is on, the Display light/Holiday button surround illuminates.

Holiday Mode

- Press the Display light/Holiday button and hold for 3 seconds.



- Set the number of day's holiday using the Up/Down arrow buttons. This can be between 0 to 31 days. The day number will flash during setting, and the suitcase symbol will appear. Press the Set button once to confirm and exit, or confirm and exit by leaving the screen to time out after 15 seconds.

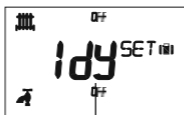

The day number will flash, and the suitcase symbol will appear



Use the Up/Down arrows to set the number of days



Use the Set button to confirm and exit

- The holiday duration will be displayed in the top right had corner of the screen.

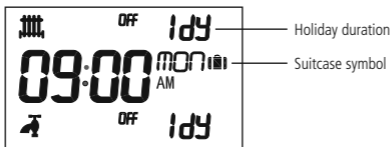

- To cancel the holiday, press the Display light/Holiday button and hold for 3 seconds. The holiday duration and suitcase symbol will disappear.



3 Year Guarantee

In the unlikely event of this product becoming faulty due to defective material or manufacture within 3 years of the date of purchase, please return it to your supplier in the first year with proof of purchase and it will be replaced free of charge. For the second and third years or any difficulty in the first year telephone the helpline on 020 8450 0515.

Note: A proof of purchase is required in all cases. For all eligible replacements (where agreed by Timeguard) the customer is responsible for all shipping/postage charges outside of the UK. All shipping costs are to be paid in advance before a replacement is sent out.



If you experience problems, do not immediately
return the unit to the store.

Telephone the Timeguard Customer Helpline;

HELPLINE

020 8450 0515

or email helpline@timeguard.com

Qualified Customer Support Co-ordinators will be on-line
to assist in resolving your query.



A **theben** Group Company

For a product brochure please contact:

Timeguard Limited.

Victory Park, 400 Edgware Road,
London NW2 6ND

Sales Office: 020 8452 1112
or email csc@timeguard.com

www.timeguard.com