

TRITON

***Topaz T100si
thermostatic control
electric shower***



**Installation and
Operating
Instructions**

Installers please note these instructions are to be left with the user

<i>CONTENTS</i>	<i>Page</i>
Important safety information	1
Introduction	2
Specifications	2
Understanding your Topaz	2
Key to main components	3
Electrical requirements	4 - 5
Water requirements	6
Siting of the shower	6 - 7
Fitting the shower to the wall	7 - 8
Plumbing connections	8
Electrical connections	9
Commissioning	9 - 10
Replacing the cover	10
Operating the shower	11 - 12
Operating functions	12 - 13
Changing the fascia	13
Fitting the ANTLER riser rail	14
Fitting the ARC riser rail	15
Adjusting and cleaning the sprayhead	16
Cleaning the inlet filter	17
Cleaning the scale trap	17
Spare parts	18 - 19
Fault finding	20 - 21
Guarantee, service policy, etc.	rear cover

To ensure the product suitability for commercial and multiple installations, please contact Triton's specification advisory service prior to installation.

Telephone: (024) 7632 5491

Facsimile: (024) 7632 4564

E mail: technical@triton.plc.uk

PLEASE READ THIS IMPORTANT SAFETY INFORMATION

- ◆ Products manufactured by Triton are safe and without risk provided they are installed, used and maintained in good working order in accordance with our instructions and recommendations.
- ◆ DO NOT operate shower if frozen, or suspected of being frozen. It must thaw out before using.
- ◆ DO NOT operate the unit if the sprayhead or spray hose becomes damaged.
- ◆ DO NOT restrict flow out of shower by placing sprayhead in direct contact with your body.
- ◆ DO NOT operate the shower if water ceases to flow during use or if water has entered inside the unit because of an incorrectly fitted cover.

1 GENERAL

1.1 Isolate the electrical and water supplies before removing the cover.

1.2 Read all of these instructions and retain them for later use.

1.3 DO NOT take risks with plumbing or electrical equipment.

1.4 Isolate electrical and water supplies BEFORE proceeding with the installation.

1.5 The unit must be mounted onto the finished wall surface (on top of the tiles). DO NOT tile up to unit after fixing to wall.

1.6 Contact Customer Service (see back page), if any of the following occur;

a) If it is intended to operate the shower at pressures above the maximum or below the minimum stated.

b) If the unit shows a distinct change in performance.

c) If the shower is frozen.

1.7 If it is intended to operate the shower in areas of hard water (above 200 ppm temporary hardness), a scale inhibitor may have to be fitted. For advice on the Triton Scale Inhibitor, contact Triton Customer Service.

1.8 The sprayhead must be cleaned regularly with descaler to remove scale and debris, otherwise restrictions to the flow on the outlet of the unit will result in higher temperatures and could also cause the Pressure Relief Device in the unit to operate.

1.9 This product is not suitable for mounting into steam rooms or steam cubicles.

2 PLUMBING

2.1 The plumbing installation must comply with Water Regulations, Building Regulations or any particular regulations as specified by Local Water Company or Water Undertakers and should be in accordance with BS 6700.

2.2 The supply pipe must be flushed to clear debris before connecting to the shower unit.

2.3 DO NOT solder pipes or fittings within 300mm

of the shower appliance, as heat transfer can damage components.

2.4 DO NOT fit any form of outlet flow control as the outlet acts as a vent for the heater can.

2.5 DO NOT use excessive force when making connections to the flexible hose or sprayhead, finger tightness is sufficient.

2.6 All plumbing connections MUST be completed BEFORE making the electrical connections.

3 ELECTRICAL

3.1 The installation must comply with BS 7671 'Requirements for electrical installations' (IEE wiring regulations) or any particular regulations as specified by the local Electrical Supply Company.

3.2 This appliance MUST be earthed.

3.3 In accordance with 'The Plugs and Sockets etc. (Safety) Regulations 1994', this appliance is intended to be permanently connected to the fixed wiring of the electrical mains system.

3.4 Ensure all electrical connections are tight to prevent overheating.

3.5 Fuses do not give personal protection against electric shock.

3.6 *To enhance electrical safety* a 30mA residual current device (RCD) should be installed in all UK electric and pumped shower circuits. This may be part of the consumer unit or a separate unit.

3.7 Switch off immediately at isolating switch if water ceases to flow during use.

3.8 Other electrical equipment i.e. extractor fans, pumps must not be connected to the circuits within the unit.

3.9 Switch off at isolating switch when not in use. This is a safety procedure recommended with all electrical appliances.

3.10 As with all electrical appliances it is recommended to have the shower and installation checked at least every two years by a competent electrician to ensure there is no deterioration due to age and usage.

INTRODUCTION

This book contains all the necessary installation and operating instructions for your Triton Topaz T100si thermostatic electric shower.

Take time to read this book thoroughly and familiarise yourself with all instructions **before** commencing installation. Please keep it for future reference.

The shower installation must be carried out by a suitably qualified person and in the sequence of this instruction book.

Care taken during the installation will ensure a long, trouble-free life from your shower.

SPECIFICATIONS

Electrical

Nominal power rating at 240V	Nominal power rating at 230V
8.5kW – (40A MCB rating)	7.8kW – (40A MCB rating)
9.5kW – (40A MCB rating)	8.7kW – (40A MCB rating)
10.5kW – (45A MCB rating)	9.6kW – (45A MCB rating)

Water

Inlet connection – 15mm diameter.
Outlet connection – 1/2" BSP male thread.

Entry Points

Water and cable – top, bottom or back.

Materials

Backplate, cover, controls, sprayhead – ABS.
Sprayplate – Acetal.
Elements – Minerally insulated corrosion resistant metal sheathing.

Dimensions

Height - 335mm
Width - 225mm
Depth - 95mm

Standards and Approvals

Waterproof rating IPX4.
Complies with the requirements of current British and European safety standards for household and similar electrical appliances.
Complies with requirements of the British Electrotechnical Approvals Board (BEAB).
Meets with Compliance with European Community Directives (CE).

UNDERSTANDING YOUR TOPAZ

Temperature/flow rate

The temperature control on the unit can be adjusted to provide shower temperatures nominally between 35°C and 47°C. The unit will give higher and lower temperatures if given extreme supply conditions.

Note: The maximum flow rate for the given temperature will be greater in the Summer than in Winter because of ambient temperature variance of the mains water supply.

It is strongly advised to select economy power during periods of hot weather, otherwise at all other times, leave the power setting at full to provide the maximum flow rate.

Safety cut-out

The unit is fitted with a non-resettable over-temperature safety device. In the event of abnormal operation which could cause unsafe temperatures within the unit, the device will disconnect the heating elements. It will require a visit from a qualified engineer to determine the nature of the fault and replace the safety device, once the unit has been repaired.

Replacement parts can be ordered from Customer Service. See 'spare parts' for details and part numbers.

Due to continuous improvement and updating, specification may be altered without prior notice.

Important: When first installed the unit will be empty. It is essential the unit should contain water before the elements are switched on. As this unit has electronic control, it is vital that the commissioning procedure is followed. Failure to carry out this operation will result in damage to the unit and will invalidate the guarantee.

KEY TO MAIN COMPONENTS

Inside unit

- 1 Top cable / pipe entry
- 2 Bottom cable / pipe entry
- 3 Wall screw fixings
- 4 Power Printed Circuit Board
- 5 Thermal cut-out
- 6 Can and element assembly
- 7 Ribbon cable connector
- 8 Terminal block
- 9 Earth connection
- 10 PRD
- 11 Solenoid valve
- 12 Trim plate
- 13 Thermostatic valve
- 14 Scale trap
- 15 Pressure switch
- 16 Shower outlet
- 17 Guide pockets

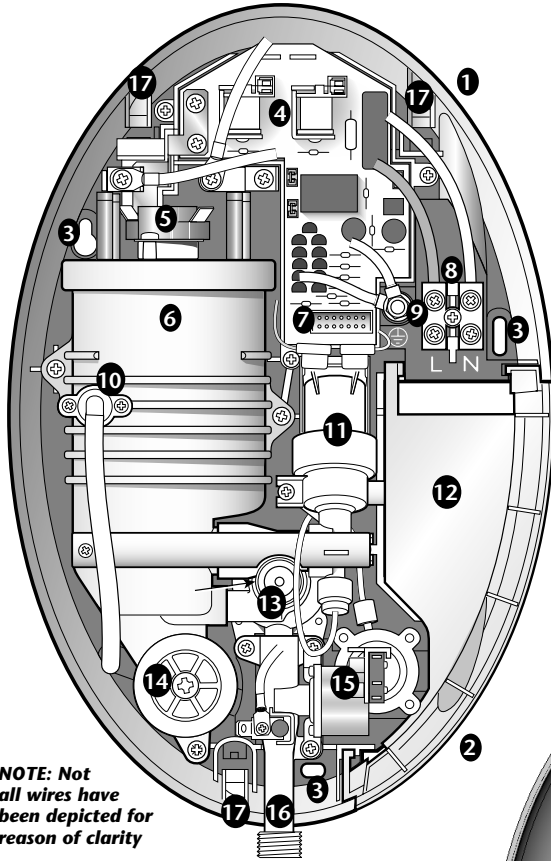

NOTE: Not all wires have been depicted for reason of clarity

Inside cover

- 18 Control Printed Circuit Board
- 19 Start/stop Printed Circuit Board
- 20 Cover tags
- 21 Ribbon cable

Pack contents

- Shower unit
- Four position sprayhead
- Riser rail kit
- Spray hose
- Soap dish
- Screw fixing kit
- Instructions, guarantee, etc.

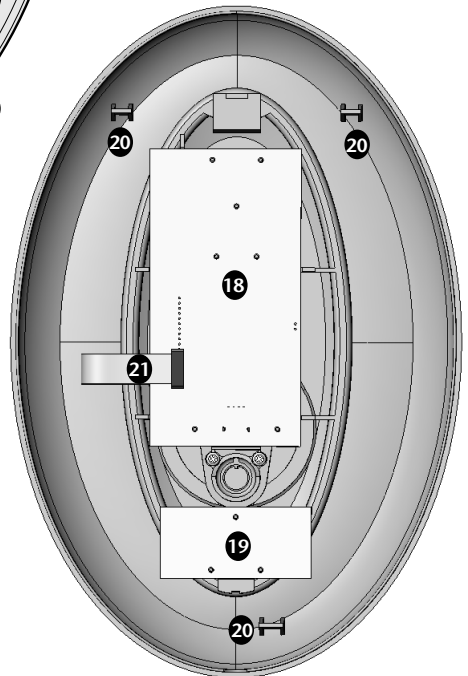

ELECTRICAL REQUIREMENTS

WARNING!
THIS APPLIANCE MUST BE EARTHED

The installation, supply cable and circuit protection must conform with IEE wiring regulations and be sufficient for the amperage required.

The following notes are for guidance only:

1 The shower must only be connected to a 230-240V ac supply. If you are installing a shower with a kilowatt rating above 9kW, it is advisable to contact the local electricity supply company.

1.1 The electrical rating of the shower is shown on the rating label (**see below**) within the unit.

TRITON	Shepperton Park Caldwell Road Nuneaton Warks CV11 4NR
	MODEL 230-240V ~
MAX. PRESSURE	IPX4 BEAB Approved
MIN. PRESSURE	
RATED PRESSURE	
MODEL No. 00000000	
SERIAL No. 00000000	

2 Before making any sort of electrical connection within the installation, ensure that no terminal is live. If in any doubt, switch off the whole installation at the consumer unit.

3 The shower must be connected to its own independent electrical circuit. IT MUST NOT be connected to a ring main, spur, socket outlet, lighting circuit or cooker circuit.

3.1 The electrical supply must be adequate for the loading of the unit and existing circuits.

4 Check your consumer unit (main fuse box) has a main switch rating of 80A or above and that it has a spare fuse way which will take the fuse or miniature circuit breaker (MCB) necessary for the shower (**see schematic of installation circuit opposite**).

4.1 If your consumer unit has a rating below 80A or if there is no spare fuse way, then the installation will not be straight forward and may require a new consumer unit serving the house or just the shower.

4.2 You will need to contact the local electricity company. They will check the circuit and carry out what is necessary. They will also check the main bonding.

5 The earth continuity conductor of the electrical installation must be effectively connected electrically to all exposed metal parts of other appliances and services in the room in which the shower is to be installed, to conform to current IEE regulations.

5.1 All exposed metallic parts in the bathroom must be bonded together using a cable of at least 4mm² cross sectional area. These parts include metal baths, radiators, water pipes, taps and waste fittings.

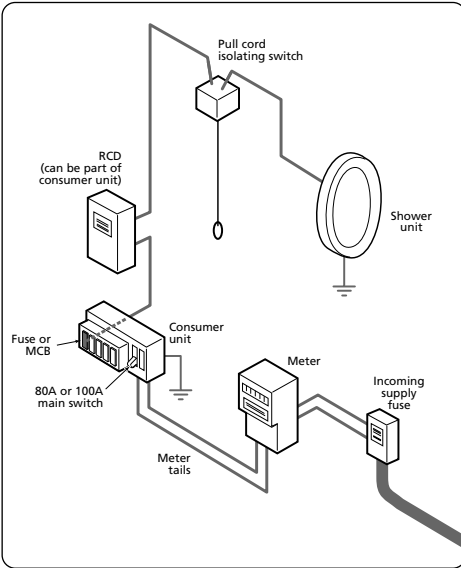

6 For close circuit protection DO NOT use a rewirable fuse. Instead use a suitably rated miniature circuit breaker or cartridge fuse (see table below).

CIRCUIT PROTECTION		
unit rating	MCB	cartridge fuse
7.0kW	30/32A	30A
7.5kW	32A	35A
8.0kW	40A	35A
8.5kW	40A	45A
9.0kW	40A	45A
9.5kW	40/45A	45A
10.5kW	45A	45A

6.1 In the interest of electrical safety a 30mA residual current device (RCD) should be installed in all UK electric and pumped shower circuits. This may be part of the consumer unit or a separate unit.

7 A 45 amp double pole isolating switch with a minimum contact gap of 3mm in both poles must be incorporated in the circuit.

7.1 It must have a mechanical indicator showing when the switch is in the OFF position, and the wiring must be connected to the switch without the use of a plug or socket outlet.

7.2 The switch must be accessible and clearly identifiable, but out of reach of a person using a fixed bath or shower, except for the cord of a cord operated switch, and should be placed so that it is not possible to touch the switch body while standing in a bath or shower cubicle. It should be readily accessible to switch off after using the shower.

8 Where shower cubicles are located in any rooms other than bathrooms, all socket outlets in those rooms must be protected by a 30mA RCD.

9 To obtain full advantage of the power provided by the shower, use the shortest cable route possible from the consumer unit to the shower.

9.1 The current carrying capacity of the cable must be at least that of the shower circuit protection (see table below).

Twin and earth PVC insulated cable CURRENT CARRYING CAPACITY		
installed in an insulated wall	in conduit or trunking	clipped direct or buried in a non insulated wall
6mm ²	6mm ²	6mm ²
32A	38A	46A
10mm ²	10mm ²	10mm ²
43A	52A	63A
16mm ²	16mm ²	16mm ²
57A	69A	85A

Note: Cable selection is dependent on derating factors

9.2 It is also necessary to satisfy the disconnection time and thermal constraints which mean that for any given combination of current demand, voltage drop and cable size, there is a maximum permissible circuit length.

10 The shower circuit should be separated from other circuits by at least twice the diameter of the cable or conduit.

10.1 The current rating will be reduced if the cabling is bunched with others, surrounded by thermal loft or wall insulation or placed in areas where the ambient temperature is above 30°C. Under these conditions, derating factors apply and it is necessary to select a larger cable size.

10.2 In the majority of installations, the cable will unavoidably be placed in one or more of the above conditions. This being so, it is strongly recommended to use a minimum of 10mm cabling throughout the shower installation.

10.3 It is essential that individual site conditions are assessed by a competent electrician to determine correct cable size and permissible circuit length.

WATER REQUIREMENTS

The installation must be in accordance with Water Regulations/Byelaws.

To ensure activation of the heating elements, the shower must be connected to a mains water supply with a minimum running pressure of 100kPa (1.0 bar) at a minimum flow rate of nine litres per minute with a maximum static pressure of 1 000kPa (10 bar).

Note: For the 10.5kW rated shower, the minimum running pressure must be 150kPa (1.5 bar) at a minimum flow rate of eleven litres per minute with a maximum static pressure of 1 000kPa (10 bar). If the stated flow rates are not available, it may not be possible to achieve optimum performance from the unit throughout the year.

Under site conditions where the power supply is below 220 volts and the mains water pressure is above 5 bar, it is recommended to fit a pressure reducing valve set at 3.5 bar.

A typical system layout is shown below.

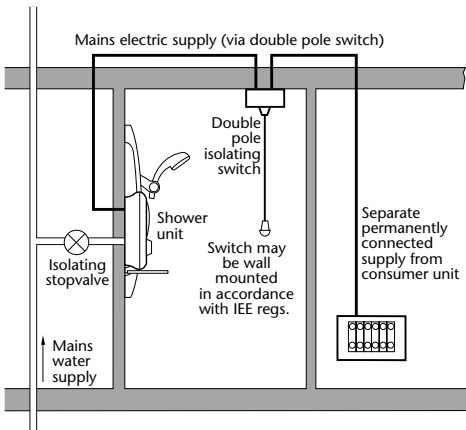

DO NOT use jointing compounds on any pipe fittings for the installation.

During periods of high ambient temperatures it may be necessary to select a low power setting to achieve your preferred shower temperature. The water supply can be taken from a cold water storage cistern provided there is a minimum head of ten metres above the sprayhead (but fifteen metres for the 10.5kW

rated shower). It must be an independent supply to the shower only.

If it is intended to operate the shower at pressures above the maximum or below the minimum stated, contact Customer Service.

SITING OF THE SHOWER

WARNING!

The shower must not be positioned where it will be subjected to freezing conditions.

FOR EASE OF SERVICING, THE UNIT MUST ALWAYS BE MOUNTED ON THE SURFACE OF TILED WALLS. NEVER TILE UP TO THE UNIT.

Refer to the illustration below for correct siting of the shower.

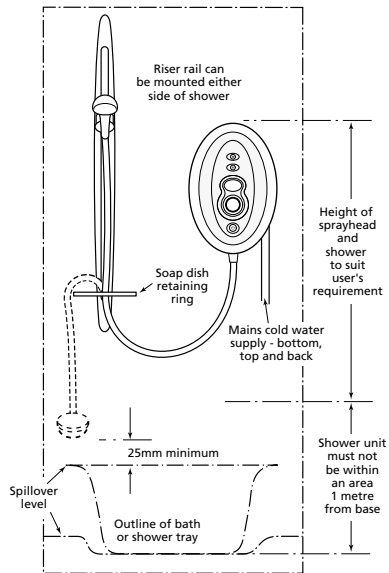

Position the unit where it will NOT be in direct contact with water from the sprayhead. Position the shower unit vertically.

Allow sufficient room between the ceiling and the shower to access the cover top screws.

IMPORTANT: The unit must be mounted on a flat surface which covers the full width and length of the backplate, otherwise difficulty may arise when fitting the cover and

subsequent operation of the unit may be impaired.

Note: Water regulations require the sprayhead be 'constrained by a fixed or sliding attachment so that it can only discharge water at a point not less than 25mm above the spill-over level of the relevant bath, shower tray or other fixed appliance'. The use of the supplied soap dish will in most cases meet this requirement, but if the sprayhead can be placed within a bath, basin or shower tray, then a double check valve, or similar, must be fitted in the supply pipework to prevent back-flow.

Liquid Crystal Display

This shower unit has a LCD which has an optimum viewing angle that is slightly below eye level. Therefore position the unit so the display is at nose level. For multiple users of varying heights, an optimum shower height must be arrived at.

Pressure relief safety device

A pressure relief device (PRD) is designed into the shower unit which complies with European standards. The PRD provides a level of appliance protection should an excessive build up of pressure occur within the shower.

DO NOT operate the shower with a damaged or kinked shower hose, or a blocked sprayhead which can cause the PRD to operate.

Ensure the PRD outlet at the bottom of the unit is not blocked.

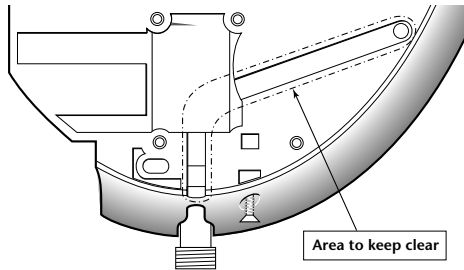

WARNING!
If planning to use a silicon seal around the backplate edge, do not place sealant in the area of the PRD exit channel.

When commissioning, the sprayhead must be removed from the flexible hose. Failure to follow this procedure may cause the PRD to operate.

Ensure the shower is positioned over a bath or shower tray because if the PRD operates, then water will eject from the bottom of the unit. Should this happen, turn off the electricity and water supplies to the shower at the isolating switch and stopvalve. Contact Customer Service for advice on replacing the PRD.

FITTING THE SHOWER TO THE WALL

Note: The control knob is an integral part of the cover – do not attempt to remove it.

Unscrew the two top and one bottom retaining screws. There is no need to completely remove the screws, just sufficient to lift the cover from the backplate. To facilitate the pipe and cable connections, remove the trimplate by just lifting away from the backplate.

Entry positions for the mains water are from the top, bottom or back. Cable entry is via the top, bottom or back.

Note: Deviations from the designated entry points will invalidate product approvals.

If bottom surface entry is required, then the necessary hole will need to be cut out in the 'thinned section' of the trimplate using a junior hacksaw and file.

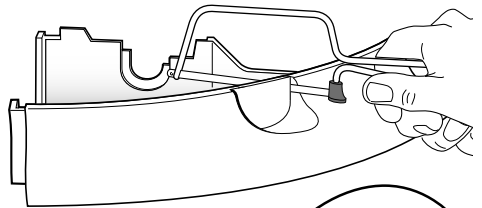

If bottom or rear entry is chosen, the pipe trim will need to be fitted in the top entry position on the backplate as shown. The pipe trim is packaged separately.

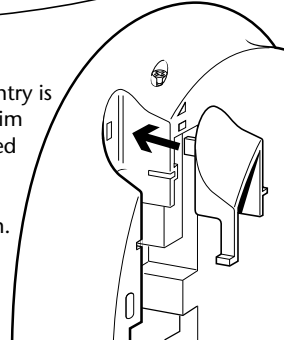

If installing a supply pipe from the rear or bottom, the centre of the inlet valve to the wall surface is 21mm.

Note: If entry is from the rear, the nut of the compression fitting will be partially behind the surface of the wall. This area **MUST** be left clear when plastering over the pipework in order to make the nut accessible for future adjustments.

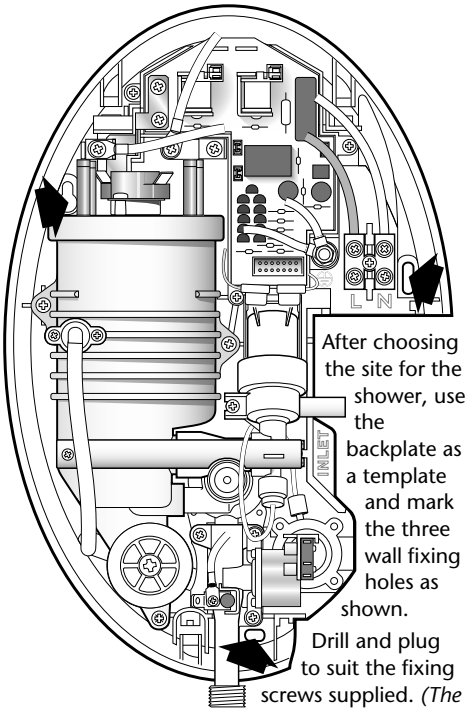

After choosing the site for the shower, use the backplate as a template and mark the three wall fixing holes as shown.

Drill and plug to suit the fixing screws supplied. (The

wallplugs provided are suitable for most brick walls – use an appropriate masonry drill, but if the wall is plasterboard or a soft building block, you must use special wallplugs and an appropriate drill obtainable from most hardware stores).

Screw the top left hand fixing screw into position leaving the base of the screw head protruding 6mm (0.25in) out from the wall.

Hook the backplate over this screw, then fit the other two fixing screws into position.

Do not fully tighten the screws at this stage, as the fixing holes are elongated to allow for out of square adjustment after the plumbing

connections have been completed.

PLUMBING CONNECTIONS

WARNING!

The outlet of the shower acts as a vent and must not be connected to anything other than the hose and sprayhead supplied.

Plumbing to precede wiring.

DO NOT use jointing compounds on any pipe fittings for the installation.

DO NOT use soldered fittings within the vicinity of the shower unit.

Compression fittings **MUST** be used to connect to the inlet of the shower.

Note: An additional stopvalve (complying with Water Regulations) **MUST** be fitted in the mains water supply to the shower as an independent means of isolating the water supply should maintenance or servicing be necessary.

Procedure

Turn off the water supply either at the mains stopvalve or the isolating stopvalve. Connect the mains water supply to the inlet of the shower via 15mm copper, stainless steel or plastic pipe using a 15mm x 15mm elbow compression fitting. The plastic filter protrudes from the inlet so ensure it is in place before connection.

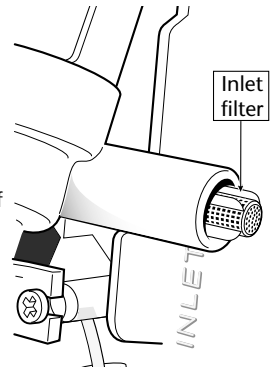

The compression fitting must be pushed fully home onto the inlet to ensure full engagement.

Note: The inlet fitting is designed to enter a compression fitting only. DO NOT use push fit connectors as full engagement cannot be guaranteed. DO NOT use excessive force when making these connections.

IMPORTANT: Before completing the connection of the water supply to the inlet of

the shower, and in compliance with Water Regulations, flush out the pipework to remove all swarf and system debris. This can be achieved by connecting a hose to the pipework and turning on the mains water supply long enough to clear the debris to waste.

Ensure the backplate is square on the wall and tighten the three retaining screws which hold it to the wall. Check the backplate is not distorted when screws are fully tightened.

Turn on the mains water supply and check for leaks in the pipework connection to the shower.

Note: At this stage no water can flow through the unit.

ELECTRICAL CONNECTIONS

A schematic wiring diagram is shown below.

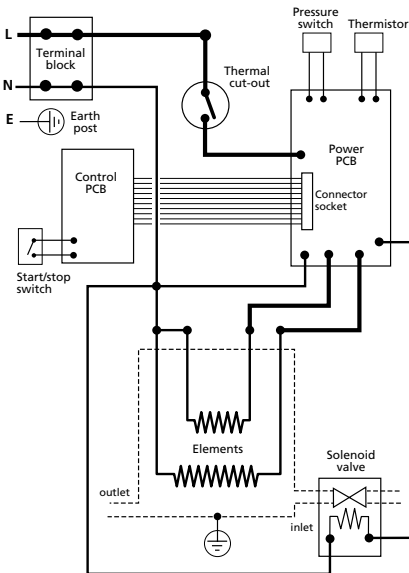

The cable entry points are top, bottom or back. The cable can be surface clipped, hidden or via 20mm conduit.

Note: Conduit entry can only be from rear.

SWITCH OFF THE ELECTRICITY SUPPLY.

Route the cable into the shower unit and connect to the terminal block as follows:

Earth cable to terminal marked **E** 

Neutral cable to terminal marked **N**

Live cable to terminal marked **L**

IMPORTANT: Fully tighten the terminal block screws and ensure that no cable insulation is trapped under the screws. Loose connections can result in cable overheating.

Note: The supply cable earth conductor must be sleeved. The outer sheath of the supply cable must be stripped back to the minimum.

The supply cable must be secured either by routing through conduit or in trunking or by embedding in the wall, in accordance with current IEE regulations.

The use of connections within the unit to supply power to other equipment i.e. extractor fans, pumps etc. will invalidate the guarantee.

DO NOT switch on the electricity supply until the cover has been fitted.

Note: The elements on UK models are to 240V specifications and will give a lower kW rating if the voltage supply is below 240V.

WARNING!
BEFORE NORMAL OPERATION OF THE SHOWER, IT IS ESSENTIAL THE FOLLOWING COMMISSIONING PROCEDURE IS COMPLETED CORRECTLY.

COMMISSIONING

The first operation of the shower is intended to flush out any remaining system debris and to ensure water is purged through the unit to ensure the heater unit contains water before the elements are switched on.

Refit the trimplate by carefully guiding into the locating slots in the backplate.

At this stage, the cover is temporarily fitted in order to carry out the commissioning procedure.

A) Offer the cover to the unit. DO NOT connect the 14-way ribbon cable at this stage.

B) Ensure the valve spindle has the 'flat' and keyway slot uppermost (12 o'clock position).

C) Ensure the temperature control knob on the cover has 'TRITON' horizontal with the blue/red graphics at the top (the knob 'flat' inside the cover

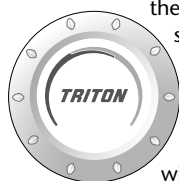

should be uppermost).

D) Carefully locate the cover tags into the guide pockets on the backplate and ensure wires are not trapped.

E) Guide into position so that the control spindle locates correctly (the 'flats' ensure the spindle and knob only fit one way). Should any difficulty arise, recheck the points above.

While applying slight pressure to the front cover, secure in position with the three retaining screws.

Fit the flexible hose (but *without* the sprayhead) to the shower outlet ensuring the outlet of the hose is directed to waste. Ensure the supplied sealing washer is in place.

Turn on the water supply to the shower at the isolating stopvalve. Switch on the electricity supply to the shower at the isolating switch.

Water will commence to flow through the unit and discharge from the flexible hose.

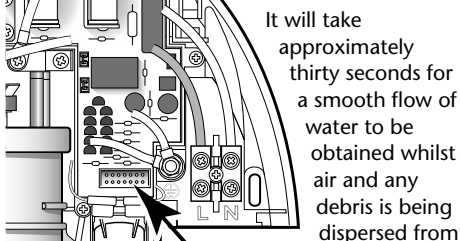

It will take approximately thirty seconds for a smooth flow of water to be obtained whilst air and any debris is being dispersed from

the shower. When a smooth flow of water is obtained, disconnect the electricity supply to the shower at the isolating switch. This will stop the

water flow. Unscrew the cover retaining screws again and lift the cover from the backplate. Attached to the control PCB, inside the cover, is a 14-way ribbon cable. The ribbon cable connector must be plugged into the socket located on the power PCB situated inside the unit (as shown). The connector can only be correctly plugged in one way by virtue of a location lug on the plug. The ribbon cable also has a coloured edge which is on the right hand side when correctly fitted to the socket.

REPLACING THE COVER

IMPORTANT: Before finally fitting the cover, the following steps must be taken:

- Check all plumbing connections are water tight.
- Check terminal block screws are fully tightened.
- Ensure pipe and cable entering the unit do not prevent the cover locating correctly to the backplate.
- Ensure the valve spindle has the 'flat' and keyway slot uppermost (12 o'clock position).
- Ensure the temperature control knob on the cover has 'TRITON' horizontal with the blue/red graphics at the top (the knob 'flat' inside the cover should be uppermost).

Offer the cover to the unit. Carefully locate the cover tags into the guide pockets on the backplate and ensure wires are not trapped. Guide into position so that the control spindle locates correctly (the 'flats' ensure the spindle and knob will only fit one way). While applying slight pressure to the front cover, secure in position with the three retaining screws.

The flexible hose can be left attached to the shower outlet. Ensure the supplied sealing washer is fitted.

Once the riser rail kit is installed, the shower is ready for normal operation.

WARNING!

If using a silicon seal around the backplate edge, ensure the PRD exit behind the outlet pipe is kept clear.

OPERATING THE SHOWER

IMPORTANT: Ensure the commissioning procedure has been carried out.

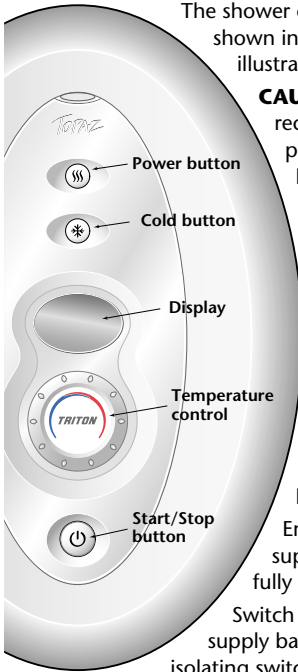

The shower controls are shown in the adjacent illustration.

CAUTION: It is recommended that persons who may have difficulty understanding or operating the shower controls should not be left unattended while using the shower. Special consideration should be given to young children and the less able bodied.

Ensure the water supply is turned fully on.

Switch the electric supply back on at the isolating switch.

Immediately, the start up routine commences and the display flashes all information for three seconds.

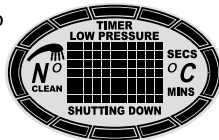

The display then shows 'OK' in a blue backlight. It will remain in this standby mode until the shower is started.

To start the shower

Press the start/stop button and water will flow.

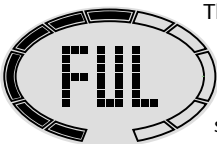

The display shows 'FUL' indicating full power is being used.

After approximately five seconds, two 'up arrows' start flashing indicating the

unit is working towards its pre-set showering temperature. This is achieved shortly when the display shows the temperature as °C.

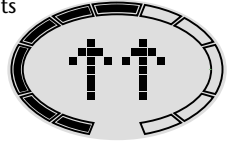

To stop the shower

Press the start/stop button and the phased shutdown will commence. The current temperature and



segments are replaced with a flashing 'SD' and 'SHUTTING DOWN' alternating on the display. Water ceases to flow after approximately five seconds after which the display returns to 'OK'.

The shower can be left in this standby mode ready for the next immediate user, otherwise, switch off at the isolating switch thus resulting in no power to the unit and a blank display.

Control buttons

Apart from the start/stop button, there are two other control buttons – power and cold.

The button marked is for cold water only.

When pressed the current display is replaced by 'CLD'. It remains in this state until the power button is pressed. (Adjustment of the temperature control at this setting has no effect on the force of the water from the sprayhead).

The button marked is the power button which is a toggle switch between full power and economy power.

Economy is for using less power when the ambient mains water temperature is high during hot months.

If the shower is on full power and the power button is pressed, the current display is

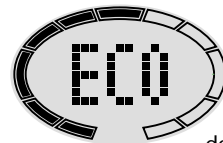

replaced by 'ECO' for five seconds. During this time, the flow rate decreases to try to achieve the same temperature as before. Note however,

that if the setting was high at full power, then it will not be possible to obtain the same temperature on economy power. The shower will endeavour to provide the highest temperature at the best flow rate.

Note: If the stated flow rate required for the unit cannot be met due to low water pressure, it will be necessary to operate the shower on economy power during hot months because of flow rate limitations entering the unit.

Full is the maximum power setting which allows the highest flow achievable for your preferred temperature.

If the shower is on economy power or the cold setting and the power button is pressed, the current display is replaced by 'FUL' for five seconds. During this time, the flow rate increases to achieve the same temperature as before or to correspond to the current temperature control position.

It is advisable to leave the power setting at full at all times, except during periods of hot weather.

To adjust the shower temperature

The showering temperature is varied by turning the temperature control which changes the mix of hot water coming from the heater can and the incoming cold water. On the display circumference are eleven outer segments which represent the total angular movement of the temperature control. Rotating the temperature control causes inner segments to move, thus indicating the actual position of the control relative to its minimum and maximum limits.

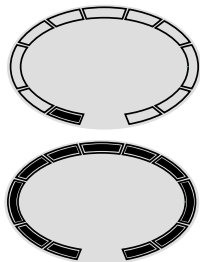

Minimum temperature position (one inner segment full that corresponds to the control position).

Maximum temperature position (all inner segments full that corresponds to the control position).

To decrease the shower temperature

Turn the temperature control anti-clockwise; the current temperature display is replaced by two flashing 'down arrows'. Five seconds later the display shows the revised temperature.

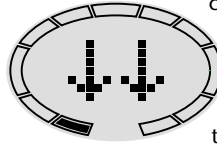

To increase the shower temperature

Turn the temperature control clockwise; the current temperature display is replaced by two flashing 'up arrows'. Five seconds later the display shows the revised temperature.

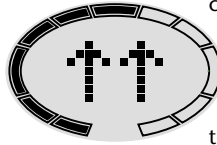

Note: It is advisable to be certain that the showering temperature is satisfactory by testing with your hand *before* stepping under the sprayhead.

There will always be a time delay of a few seconds between selecting a temperature and the water reaching the stable selected temperature.

OPERATING FUNCTIONS

Clean sprayhead

After a preset number of start/stop button operations (nominally 75), the start up routine acts as normal but instead of a blue 'OK' the display backlight turns red and a flashing 'CS' alternating with a flashing 'sprayhead symbol' and 'CLEAN' appear. This is a reminder to clean the sprayhead. It does NOT indicate a defect to the shower.



To remove the red 'CS' from the display, press the power and cold buttons simultaneously for three seconds. Alternatively you can choose not to remove the flashing indication and carry on by pressing the start/stop button and showering as normal, but the 'symbol' and 'CLEAN' will continue to flash at the side of the °C figure for a further five shower operations after which time it will cease (irrespective of whether you clean the sprayhead or not). The shower will then reset automatically for a further preset number

of shower operations before flashing the reminder again.

Low pressure

When the display backlight turns red and ‘LP’ and ‘LOW PRESSURE’ flash alternately, it means the water pressure has fallen below the minimum required for correct operation of the shower, resulting in the low pressure switch operating.



This switches off power to the heating elements preventing any maintained temperature rises (water will continue to flow).

When normal water pressure is restored, the shower automatically reverts to the settings prior to the low pressure operating. The display returns to blue and the flashing ‘LP’ is replaced by flashing ‘up arrows’ for approximately five seconds to allow the temperature to stabilise.

Phased shutdown

In use, when the start/stop button is pressed, power is switched off to the elements and the power indicator will extinguish. The display will change to a flashing ‘SD’. Water continues to flow for a few seconds, flushing out any remaining hot water. This ensures the next immediate user will not receive a slug of hot water if standing under the sprayhead when starting the shower.

Safety cut-out

The shower is fitted with a thermal cut-out safety device. In the event of abnormal operation which could cause unsafe temperatures within the unit, the device will disconnect the heating elements.

It will require a visit from a qualified engineer to determine the nature of the fault and replace the safety device, once the unit has been repaired.

CHANGING THE FASCIA

This shower unit has the facility for the coloured fascia to be simply changed for another colour of your choice. The coloured options are available as low cost accessories and are listed in the ‘parts list’ section at the rear of this booklet. To change the fascia proceed as follows:

The top of the fascia has a recessed cutaway.

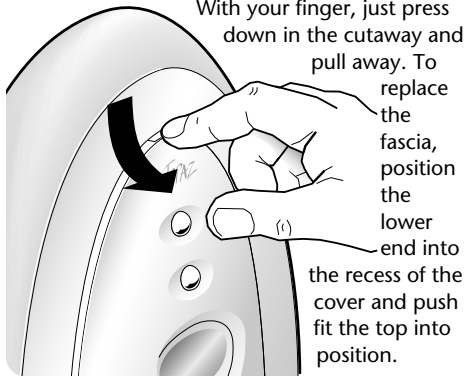

WARNING!

After any servicing of mains water supply, always ensure the unit is started on COLD in order to purge any air in the pipework.

Note: In normal use, it is in order to leave the water supply permanently on to the shower unit, but as with most electrical appliances, **the unit should be switched off at the isolating switch when not in use.**

FITTING THE ANTLER RISER RAIL

WARNING!

Check there are no hidden cables or pipes before drilling holes for wall plugs. Use great care when using power tools near water. The use of a residual current device (RCD) is recommended.

Decide the position for the rail on the wall within the shower area and proceed as follows: The sprayhead holder is supplied already attached to the rail unit and the angle of the holder dictates the rail top and bottom. The correct orientation of the rail is when the holder is sloping DOWN.

Offer the rail to the wall, and mark the two elongated upper holes and the elongated lower two holes.

DO NOT use the square edged holes (these are for engaging the lug when sliding the finishing trims into position). Ensure the rail is aligned vertically.

Drill and plug the wall.

(The wallplugs provided are suitable for most brick walls – use an appropriate masonry drill, but if the wall is plasterboard or a soft building block, use special wallplugs and an appropriate drill bit).

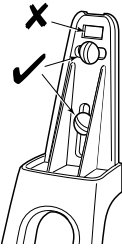

Secure to the wall with the screws supplied ensuring the sprayhead holder is sloping DOWN. Slide the finishing trims onto the riser rail bracket ends. Ensure the trim lug slides behind the rail bracket and engages correctly between the wall and bracket.

Adjusting the sprayhead holder

The holder is supplied already attached to the rail unit. To adjust the height, slightly lift the holder arm to unlock it (an audible 'click' denotes it is unlocked). Slide the holder arm up or down on the ratchet

mechanism to suit user's requirement. To lock the holder arm in position, push the arm down until it 'clicks'.

Fitting the soap dish

Carefully squeeze the soap dish ends slightly in order to open up the engagement side of the dish. Manoeuvre the dish onto the lower end of the rail while still squeezing the dish ends together. It will snap into position when located correctly, following the same contours as the rail bracket.

Hose and sprayhead

Feed the flexible hose through the appropriate soap dish aperture so the dish acts as a retaining ring (Water Regulations). Screw the flexible hose to the shower outlet and sprayhead ensuring the supplied washers are in place at both ends of the flexible shower hose.

Place the sprayhead into the holder and check that it fits correctly.

Note: The holder is slightly tapered and the sprayhead and hose will only fit from one direction.

IMPORTANT: It is the conical end of the hose which grips into the holder. The sprayhead will not fit in the holder without the hose attached.

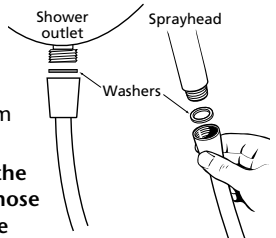

FITTING THE ARC RISER RAIL

WARNING!

Check there are no hidden cables or pipes before drilling holes for wall plugs. Use great care when using power tools near water. The use of a residual current device (RCD) is recommended.

Decide the position for the rail on the wall within the shower area and proceed as follows:

The sprayhead holder is supplied already attached to the riser rail unit and the angle of the holder dictates the rail top and bottom. The correct orientation of the rail is when the sprayhead holder is sloping DOWN.

Slide the supplied soap dish onto the riser rail below the sprayhead holder.

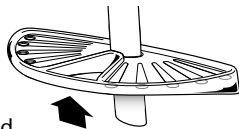

Slide the top and bottom finishing trims onto the riser rail.
Push the two fixing brackets into the ends of the riser rail.

Offer the rail assembly to the wall. Using the brackets as templates, mark two upper holes and two lower holes. Note there are four provisions for screws per bracket – select the two most suitable for your requirements. Ensure the rail is aligned vertically.

Drill and plug the wall.

(The wallplugs provided are suitable for most brick walls – use a suitable masonry drill, but if the wall is plasterboard or a soft building block, use special wallplugs and an appropriate drill bit).

Screw to the wall with the fixing screws supplied.

Slide the finishing trims onto the brackets. Ensure the lug on each rail bracket end

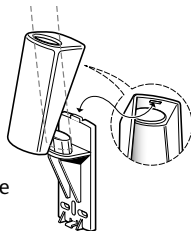

engages into the slot on the fatter end of each trim before push fitting the thinner ends in place.

To remove a trim, push a small screwdriver or similar through the slot in the trim end and carefully pull away from the wall bracket.

Slide the soap dish down the rail so that its bracket engages on top of the lower finishing trim.

Adjusting the sprayhead holder

The holder is supplied already attached to the rail unit. To adjust the height, press the button underneath the holder to release the locking mechanism. Still pressing the button, move the holder up or down to suit user's requirement.

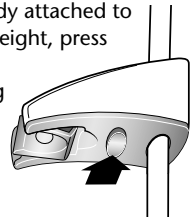

Hose and sprayhead

Feed the flexible hose through the soap dish aperture so the dish acts as a retaining ring (Water Regulations).

Screw the flexible hose to the shower outlet and sprayhead ensuring the supplied washers are in place at both ends of the flexible hose.

Place the sprayhead into the holder and check that it fits correctly.

Note: The holder is slightly tapered and the sprayhead and hose will only fit from one direction.

IMPORTANT: It is the conical end of the hose which grips into the holder. The sprayhead will not fit in the holder without the hose attached.

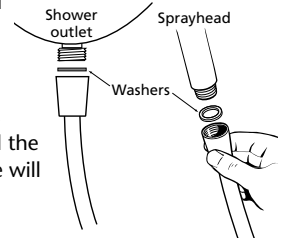

ADJUSTING THE SPRAYHEAD

Four sprayhead patterns are available. Adjustment is by turning the bezel on the sprayhead in either direction until the desired pattern is obtained.

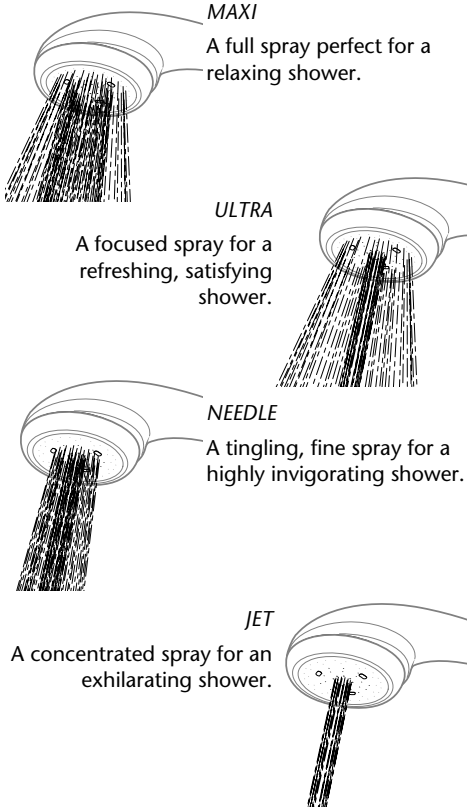

CLEANING

Do not use abrasive or solvent cleaning fluids. The shower unit, riser rail, hose, etc. should be cleaned using a soft cloth and warm water.

It is advised before cleaning, to turn the isolation switch off, thus avoiding the shower being accidentally switched on.

IT IS IMPORTANT TO KEEP THE SPRAYHEAD CLEAN TO MAINTAIN THE PERFORMANCE OF THE SHOWER.

The hardness of the water will determine the frequency of cleaning. For example, if the shower is used every day in a very hard water area, it may be necessary to clean the sprayhead on a weekly basis.

Sprayplate removal

There is no need to remove the sprayhead from the hose.

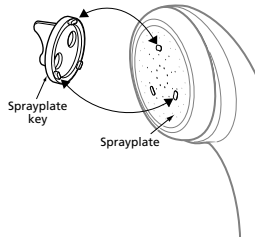

Using the removal tool supplied (as shown), locate the three raised 'bosses' into the three recesses in the sprayplate. Hold in firmly and twist anti-clockwise.

This movement may turn the cartridge assembly as well until it reaches a 'stop'.

Hold the cartridge firmly and continue to twist anti-clockwise.

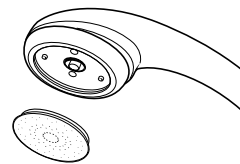
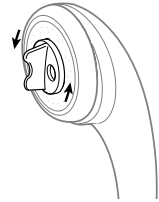

Having loosened the sprayplate sufficiently, it can be unscrewed and removed completely. Clean the sprayplate with a suitable brush or preferably leave it

to soak overnight in a mild proprietary descaler. Ensure all traces of scale are removed and thoroughly rinse in clean water afterwards. Before replacing the sprayplate, switch the power back on at the isolating switch and direct the hose and sprayhead to waste.

Press the start/stop button followed by the 'COLD' button.

This operation will flush out any loose scale deposits in the unit and sprayhead. Stop after approximately thirty seconds.

Refit the sprayplate by screwing clockwise. Use the tool to screw the sprayplate tight.

INSTRUCTIONS FOR INSTALLERS AND SERVICE ENGINEERS ONLY

CLEANING THE INLET FILTER

It is recommended that the filter is periodically cleaned in order to maintain the performance of the shower. *It is essential that this operation is carried out by a competent person.*

SWITCH OFF THE ELECTRICITY SUPPLY.

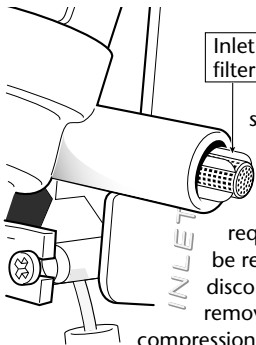

Remove the cover.

The inlet filter is situated in the solenoid inlet (as shown) and can be removed to clean.

To gain access to the filter will require the trimplate to be removed and disconnection and removal of the compression fitting. Also,

depending on the incoming pipework arrangements, if there is not enough slack in the pipework, it could mean the removal of the unit from the wall.

When cleaning the plastic filter, DO NOT use a sharp object, as it will cause damage. It is preferable to use an old toothbrush or similar.

CLEANING THE SCALE TRAP

It is recommended in hard water areas, the scale trap is periodically cleaned to maintain the performance of the shower. *It is essential that this operation is carried out by a competent person.*

SWITCH OFF THE ELECTRICITY SUPPLY.

Remove the cover and unplug the ribbon cable. The scale trap is located at the lower left-hand side of the unit. Unscrew the single central screw then pull off the cap complete with 'O' rings.

Be aware of water discharging as the heater can exhausts.

Clean out the trap and remove all sediment.

Flush the can through by leaving the cap off and switching on the power at the isolating switch.

Note: Ensure the water that flows out of the scale trap will safely flow to waste.

Switch the power off at the isolating switch. Replace the cap ensuring the 'O' rings are in place and free from debris. Secure with the central screw.

Switch the power back on again at the isolating switch to enable the can to fill with water. Check for water leakage at the scale trap. When water flows smoothly from the sprayhead, stop the flow by switching the power off at the isolating switch.

Reconnect the ribbon cable and replace the cover and secure with the three screws.

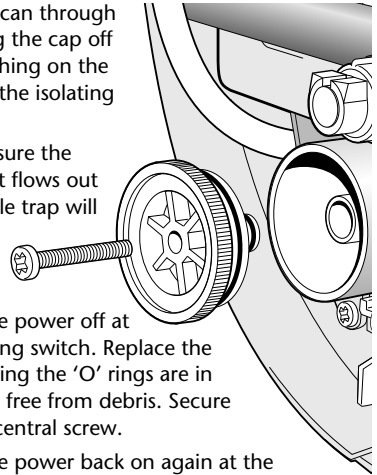

SPARE PARTS

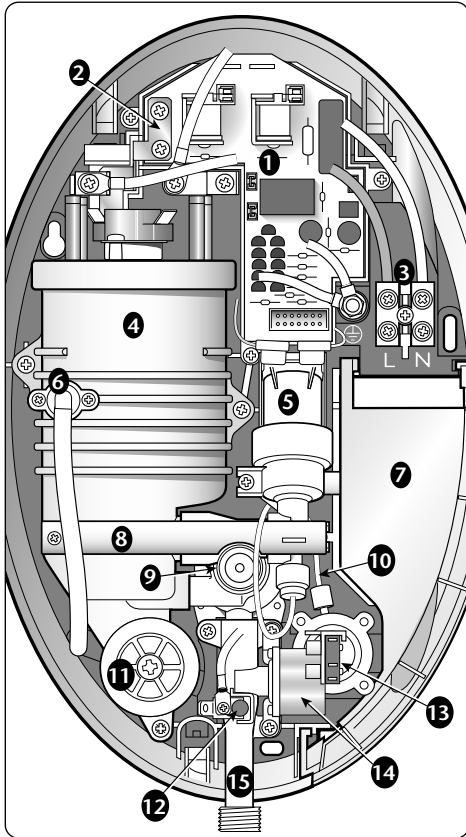

Ref.	Description	Part No.
1	Printed circuit board - Power 8.5kW & 9.5kW	7073034
	Power 10.5kW	7073169
2	Copper bus bar	7023005
3	Terminal block & wires	S07710900
	Terminal block	22009230
4	Heater can assembly 8.5kW c/w restrictor & TCO	83307080
	Heater can assembly 9.5kW c/w restrictor & TCO	83307090
	Heater can assembly 10.5kW c/w restrictor & TCO	83307100
-	Restrictor 8.5kW	22010400
-	Restrictor 9.5kW	22010310
-	Restrictor 10.5kW	22010410
5	Solenoid valve assy. and 'O' ring	83307110
6	Pressure Relief Device	82800450
7	Trimplate	7052989
8	Can brace	7053008
9	Thermostatic valve and 'O' rings (4)	83307130
10	Connecting tube	22010260
11	Scale trap cover c/w 'O' rings and screw	83307140
12	Display thermistor	22010300
13	Pressure switch microswitch & wires	P07710904
14	Pressure switch and 'O' ring	83307120
15	Outlet pipe assembly	S07711000
	Cover assembly c/w control PCB, start/stop PCB, knobs & buttons	83307160
	Wire set 2 x earth & 1 x solenoid wires	83307150
-	Power PCB carrier	7052991
-	Rubber microswitch cover	7063046
-	Inlet filter	7053009

SPARE PARTS

Ref. Description

Part No.

16	<i>Coloured fascias</i> Seaspray Aqua Azure Lilac Midnight Chrome	TSTZFSEA TSTZFAQU TSTZFAZU TSTZFLIL TSTZFMID TSTZFCHR
17	4 mode sprayhead – white	22420050
18	Flexible hose – white	22003960
<i>Arc kit</i>		
19	Brackets (pr.)	22010430
20	Trims (pr.) – white	22010440
21	Riser rail – white	22010450
22	Sprayhead holder – white	22010460
23	Soap dish	22010470
<i>Antler kit</i>		
24	Trims (pr.) – white	22010480
25	Riser rail and holder assy. white	22010490
26	Soap dish	22010500

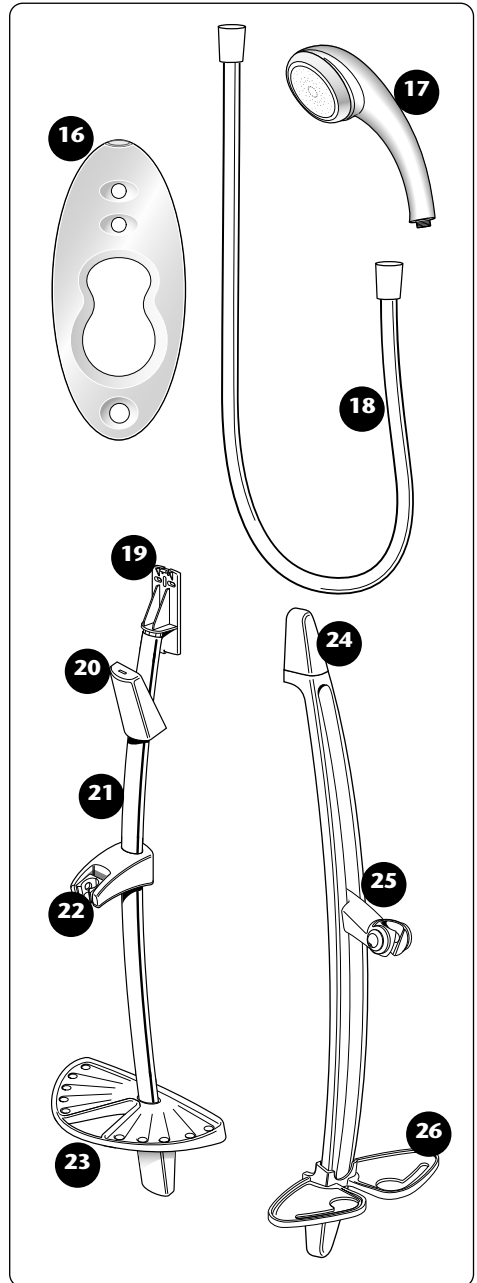

FAULT FINDING

IMPORTANT: Switch OFF the electricity at the mains supply and remove the circuit fuse before removing the cover from the shower while attempting any fault finding inside the unit.

<i>Problem/Symptom</i>	<i>Cause</i>	<i>Action/cure</i>
1 Shower inoperable.	1.1 Interrupted power supply.	1.1.1 Blown fuse or circuit breaker. Check supply. Renew or reset fuse or circuit breaker. If it fails again, consult a qualified electrician. 1.1.2 Power cut? Check other appliances and if necessary, contact local Electric Supply Co.
	1.2 Unit malfunction.	1.2.1 Have unit checked by suitably qualified electrician or contact Customer Service.
2 Water flows when isolating switch is switched on	2.1 Ribbon cable is not connected.	2.1.1 Switch off the electric supply, remove the shower cover and plug in ribbon cable.
	2.2 Unit malfunction.	2.2.1 Contact Customer Service.
3 Water too hot.	3.1 Temperature control incorrect setting.	3.1.1 Turn anti-clockwise.
	3.2 Unit malfunction.	3.2.1 Contact Customer Service.
4 Unstable shower temperature or flow.	4.1 Blockages.	4.1.1 Clean sprayhead. Check inlet filter.
	4.2 Loose ribbon cable connection.	4.2.1 Check connections on PCB.
	4.3 Unit malfunction.	4.3.1 Contact Customer Service.
5 Water too cool or cold.	5.1 Temperature control incorrect setting.	5.1.1 Turn clockwise.
	5.2 Unit malfunction.	5.2.1 Contact Customer Service.
	5.3 Safety cut-out operated.	5.3.1 The thermal safety cut-out device has operated. Have unit checked by suitably qualified electrician or contact Customer Service.

FAULT FINDING (continued)

<i>Problem/Symptom</i>	<i>Cause</i>	<i>Action/cure</i>
6 'LP' flashing on display.	6.1 Water pressure has dropped below minimum required.	6.1.1 Wait until water pressure has returned to normal.
	6.2 Blockage in outlet.	6.2.1 Check and clean outlet and/or sprayhead.
	6.3 Loose connection on PCB.	6.3.1 Check connection on PCB from pressure switch.
	6.4 Blocked connecting tube to pressure switch.	6.4.1 Ensure the tube from solenoid valve to pressure switch is not kinked or blocked.
7 Water continues to flow when unit is isolated at isolating switch.	7.1 Debris in solenoid.	7.1.1 Contact Customer Service for advice.
8 Pressure relief device has operated (water ejected from PRD tube).	8.1 Blocked sprayhead.	8.1.1 Clean or replace blocked sprayhead cartridge and then fit a new PRD.
	8.2 Twisted/blocked flexible shower hose.	8.2.1 Check for free passage through hose. Replace the hose if necessary, then fit new PRD.
	8.3 Sprayhead not removed whilst commissioning.	8.3.1 Fit new PRD. Commission unit with sprayhead removed.

Note: Identify cause of operation before fitting new PRD unit. When fitting a new PRD, follow the commissioning procedure.

It is advised all electrical maintenance/repairs to the shower should be carried out by a suitably qualified person.



A **MORGROS** Company

Service Policy

In the event of a complaint occurring, the following procedure should be followed:

1 Telephone Customer Service on (024) 7637 2222 (08457 626591 in Scotland and in Northern Ireland), having available the model number and power rating of the product, together with the date of purchase.

2 Triton Customer Service will be able to confirm whether the fault can be rectified by either the provision of a replacement part or a site visit from a qualified Triton service engineer.

3 If a service call is required it will be booked and the date of call confirmed. In order to expedite your request, please have your postcode available when booking a service call.

4 It is essential that you or an appointed representative (who must be a person of 18 years of age or more) is present during the service engineer's visit and receipt of purchase is shown.

5 A charge will be made in the event of an aborted service call by you but not by us, or where a call under the terms of guarantee has been booked and the failure is not product related (i.e. scaling and furring, incorrect water pressure, pressure relief device operation, electrical installation faults).

6 If the product is no longer covered by the guarantee, a charge will be made for the site visit and for any parts supplied.

7 Service charges are based on the account being settled when work is complete, the engineer will then request payment for the invoice. If this is not made to the service engineer or settled within ten working days, an administration charge will be added.

Replacement Parts Policy

Availability: It is the policy of Triton to maintain availability of parts for the current range of products for supply after the guarantee has expired. Stocks of spare parts will be maintained for the duration of the product's manufacture and for a period of five years thereafter.

In the event of a spare part not being available a substitute part will be supplied.

Payment: The following payment methods can be used to obtain spare parts:

1 By post, pre-payment of pro forma invoice by cheque or money order.

2 By telephone, quoting credit card (MasterCard or Visa) details.

3 By website order, www.tritonshowers.co.uk

Triton Plc
Shepperton Park
Caldwell Road
Nuneaton
Warwickshire CV11 4NR

TRITON STANDARD GUARANTEE

Triton Plc guarantee this product against all mechanical and electrical defects arising from faulty workmanship or materials for a period of two years for domestic use only, from the date of purchase, provided that it has been installed by a competent person in full accordance with the fitting instructions.

Any part found to be defective during this guarantee period we undertake to repair or replace at our option without charge so long as it has been properly maintained and operated in accordance with the operating instructions, and has not been subject to misuse or damage.

This product must not be taken apart, modified or repaired except by a person authorised by Triton Plc. This guarantee applies only to products installed within the United Kingdom and does not apply to products used commercially. This guarantee does not affect your statutory rights.

What is not covered:

1 Breakdown due to: a) use other than domestic use by you or your resident family; b) wilful act or neglect; c) any malfunction resulting from the incorrect use or quality of electricity, gas or water or incorrect setting of controls; d) faulty installation.

2 Repair costs for damage caused by foreign objects or substances.

3 Total loss of the product due to non-availability of parts.

4 Compensation for loss of use of the product or consequential loss of any kind.

5 Call out charges where no fault has been found with the appliance.

6 The cost of repair or replacement of pressure relief devices, sprayheads, hoses, riser rails and/or wall brackets, isolating switches, electrical cable, fuses and/or circuit breakers or any other accessories installed at the same time.

7 The cost of routine maintenance, adjustments, overhaul modifications or loss or damage arising therefrom, including the cost of repairing damage, breakdown, malfunction caused by corrosion, furring, pipe scaling, lime scale, system debris or frost.

Customer Service: ☎ (024) 7637 2222

**Scottish and Northern Ireland
Customer Service:** ☎ 08457 626591

Trade Installer Hotline: ☎ (024) 7632 5491

Fax: (024) 7632 4564

www.tritonshowers.co.uk

E mail: technical@triton.plc.uk